

# Jar of Relish

by Lar deSouza (fresco@sentex.net) © September 2001  
Designed for Dorothy Englemen, the Origami Swami picnic party

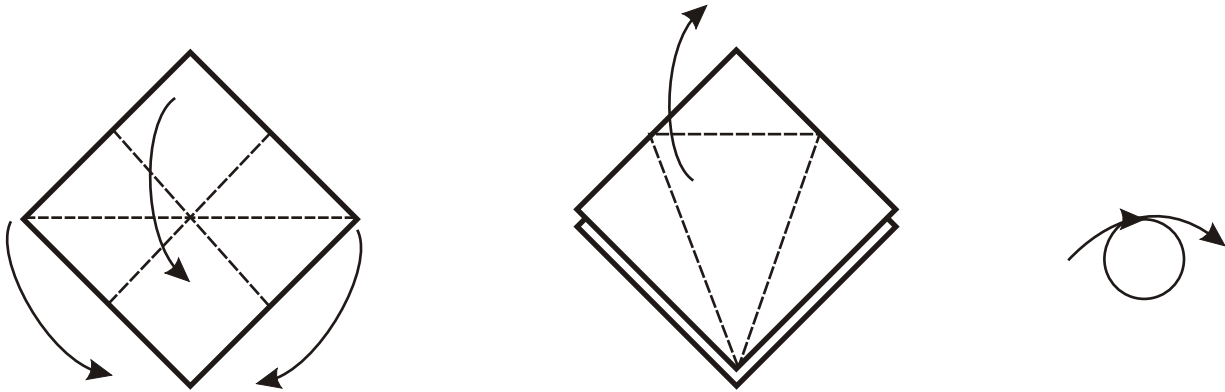

Begin with a Preliminary Base,  
coloured side out.

Petal fold one side.

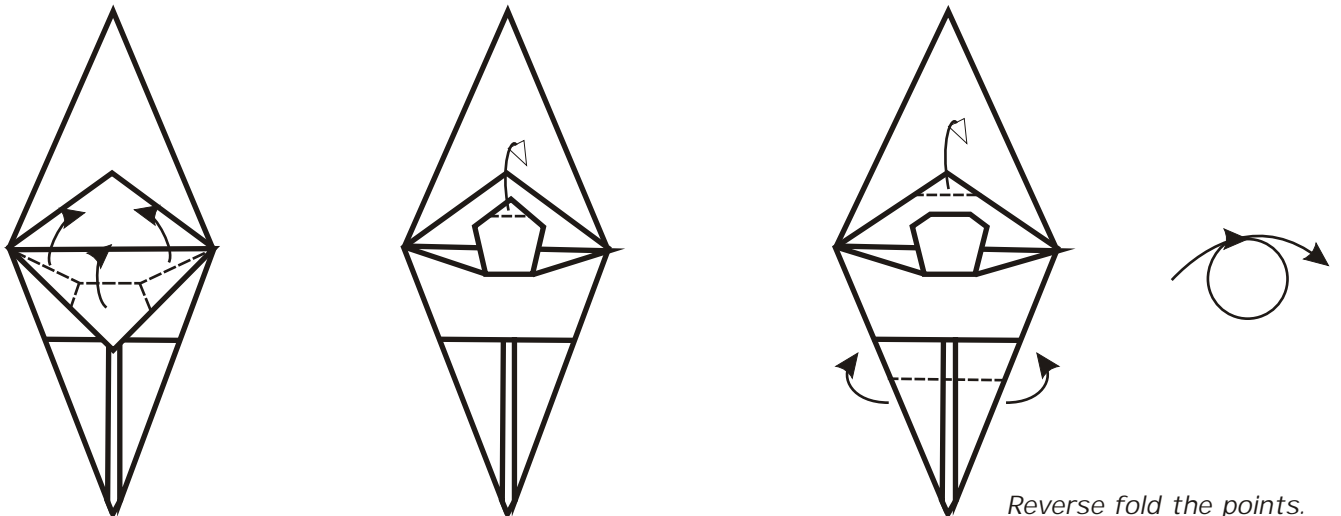
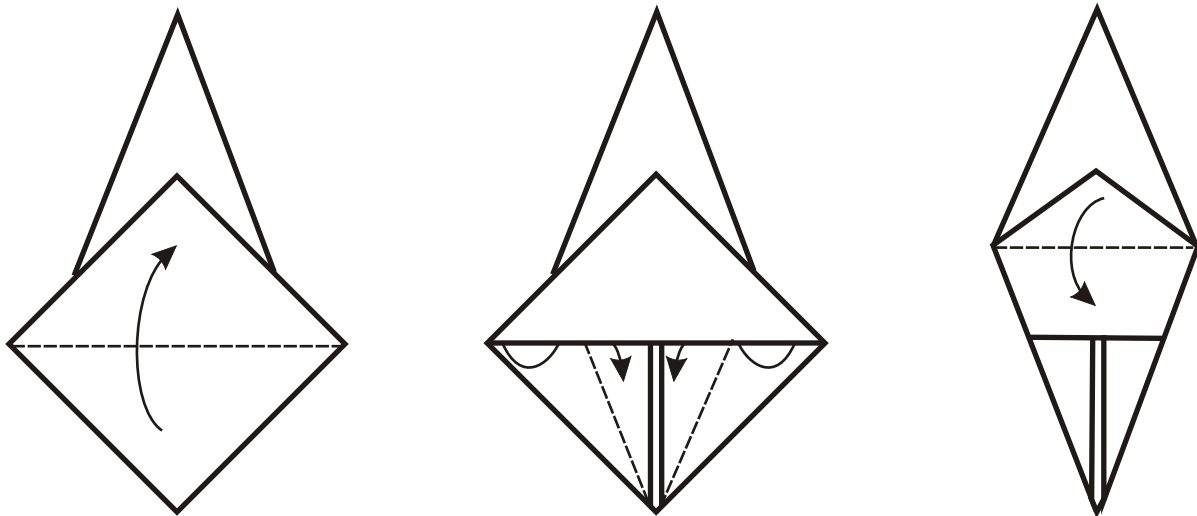

Reverse fold the points.

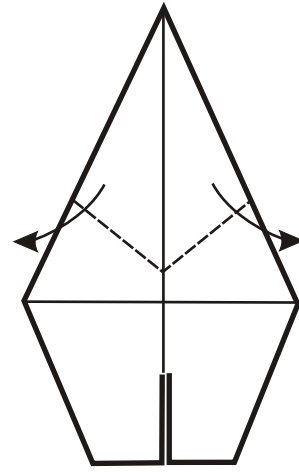
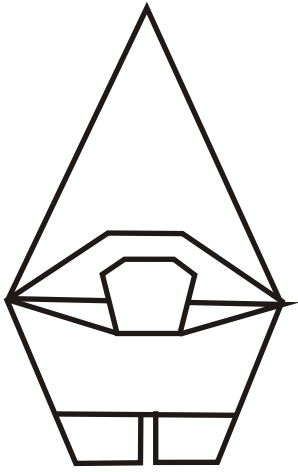

*Open out top.*

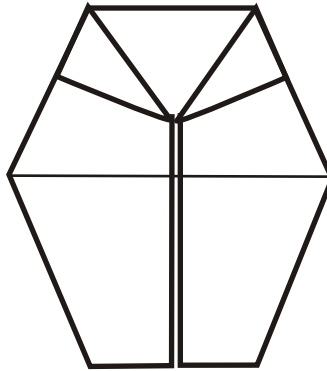
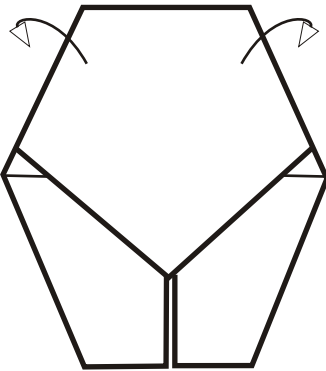

*Open top layer and wrap around.*

