

# The Bases of Folding

Joseph Fleming

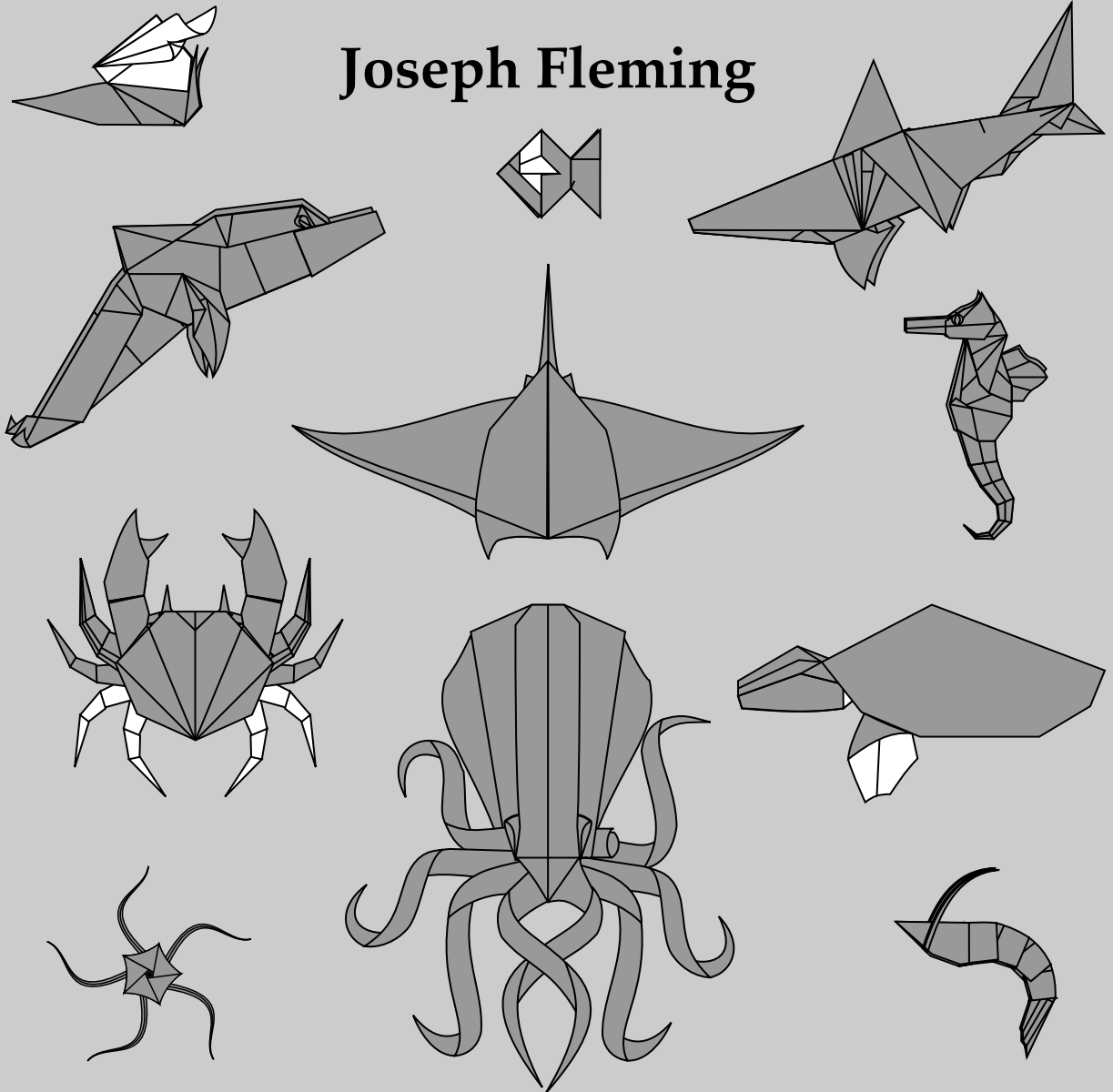

**This is a free book.**

**If you feel it is worth something more,  
you can donate to me on PayPal at  
[josephflemingorigami@gmail.com](mailto:josephflemingorigami@gmail.com).**

# **Acknowledgments**

**This book is dedicated to my mother, my biggest fan.**

**To my family, who put up with me when I got lost in my designs.**

**To every online forum I've joined over the years, for giving me the support and criticism I needed.**

**To John Montroll, Robert Lang, Joseph Wu, Marc Kirschenbaum, David Brill, and every other artist who has inspired me and influenced my work.**

**To Ondřej Cibulka, who not only diagrammed my bat model, but also improved it immensely.**

**To Sara Adams, Gilad Aharoni, and everyone who has hosted my content in the past and has agreed to do so for this book.**

**And to you, the readers, whether you were a fan before this book, or just found it by chance.**

**You are all greatly appreciated.**

*He brought His fingertips together, aligning  
The edges of reality,  
Holding them still,  
And with His right hand, with judgment,  
Formed the first of many lines,  
Like those which creased upon His brow  
And on His hands, like fingerprints  
Left by some other folding bones.  
All but those aside His eyes;  
Those He formed himself.*

*The plans were there, within the sulcus,  
Waiting to be unfurled; helical blueprints.  
Dashes and dots, angles and arrows,  
Layers and layers; complexity in a quiet existence.  
A sea of intersecting pathways – no piece untouched,  
Every square inch given purpose.*

*Kami folded no different than He;  
Both show signs that They were molded.  
And when He placed the model down  
He knew It rivaled His creation.  
For never in a thousand years  
Could He be made the same again,  
Nor could He make another like  
Those unique shapes that live beside Him.  
Remaining 'til Their time was spent  
And other shapes would take Their place.*

*That time was not upon Them,  
And there was kami left to fold.*

*He smiled*

*Another crease.*

# Introduction

When I was a child, I was something of a nightmare. I never took naps, I ruined every playpen I was ever placed in, and when I did get quiet, it usually meant I had done something destructive. My parents tried everything to keep me still for just five minutes. Drawing seemed to work; reading worked better. Then one day, I was given a book that had very few words. One page started with a square, and the next page ended with a fun new shape. It was different than any arts and crafts book I had been given before. I didn't need pencils, scissors, or glue. I just needed paper.

Of course, with my memory being as bad as it is, this story from my childhood comes courtesy of my mother, who loves to remind me how *she* introduced me to origami. If it's a question of *my* first memory of origami, that's another story entirely. In the early 2000s, I had long since fallen out of favor with origami, preferring to spend my time reading in my room. My father had bought our first home computer, which I used primarily for homework and chatting with friends. However, I grew bored rereading all of my books for the fourth (or tenth) time, so I logged into my AOL account, waited an eternity for the dial up tone to stop defiling my ears, and typed 'origami' into the web search bar.

What I found was an early era website. All black background, small white font you'd need a magnifying lens to read, and a thin strip of spreadsheet cells running down the middle of the page. As ridiculous as it would look nowadays, it was like Van Gogh's "*Starry Night*" in my eyes. Not only were there plenty of models to choose from, they were more impressive than anything I had seen before. I never knew such complexity could be achieved with one single sheet of paper. So, being the type of kid who loved a challenge, I dove head first into the most complex diagrams available. Deciphering the blurry scans of hand-drawn instructions was half the challenge, while the other half was pushing forward with models well beyond my skill range, using only loose-leaf and printer paper. I went through all the complex diagrams on that site, and started looking for more

Soon after I discovered that website, I also discovered torrenting. Though peer-to-peer sharing is still a major part of the internet, it is nowhere near as prevalent as it used to be. I spent countless nights downloading low quality music, hearing Bill Clinton's famous line about White House relations, and praying I didn't infect my laptop with yet another virus. I also, much to my present day embarrassment, downloaded a few origami books. While there wasn't much initial guilt costing multimillionaire music executives a few dollars, I felt an unshakable sense of shame downloading someone's passion project, something they painstakingly crafted themselves and for which they would likely receive little beyond community praise. That mindset rang true for everything else I wanted to download, and I soon found myself righteously bereft of diagrams to fold.

Refusing to pirate others work, and becoming increasingly busy with high school, I once again forgot about origami. But as with any teenager, I soon grew bored listening to my teachers drone on and on about subjects I either didn't care about or already understood. Thus, while sitting in junior year AP Comp, I pulled out a piece of paper. I wasn't interested in folding a thousand cranes, nor could I remember any of the models I had folded years before. I wanted to try making my own designs. I figured it would be a piece of cake. After all, I'd already folded plenty of complex origami, and was one of the top students in my class. It would seem, however, that the phrase "arrogance and ignorance go hand in hand" was coined with me in mind, and I'd soon come to appreciate

## The Bases of Folding

the tremendous amount of time, skill and effort it takes to not only design origami, but to design *good* origami.

My first design... was not good. It was a worm. Or perhaps a grub. Either way, I wasted about half the paper, used a fish base for no discernible reason, and the resulting mess would *always* tear right at the last step. Knowing what I do now, I would've tossed that model into the garbage and pretended it never happened. But if I had done that, I doubt I would've ever tried designing another model again. Instead, thanks in no small part to my youthful narcissism, I loved that model, and thought myself the next great artist, even listing this new model as an "Opus." Having made many models after that fateful day, I wanted to share my apparent genius with the world. My family obviously supported me, in much the same way a parent nods and tells their child that the blob with sticks they drew looks *just* like an elephant. I needed validation from other origami artistes like myself. So once again, I turned to the internet.

I found a forum and posted my works there, naively waiting to be showered with praise. I would soon be rudely informed of the harsh truth; I wasn't the grandmaster of paperfolding I thought myself to be. To put it bluntly, I sucked. This obviously came as a shock to my pompous sixteen year old mind. I had to prove them wrong. So I kept coming back, periodically posting new models, and sure enough I'd get heckled off the digital stage. But as time went by, and I humbled myself enough to take in some of their constructive criticism, the negative reactions became less frequent. Finally, after accepting that my models just weren't up to snuff, someone, to my amazement, asked for a diagram.

However, it wasn't all smooth sailing after that. When that first request came rolling in, I had three major problems to address. The first and most immediate issue was that I had absolutely no idea how to make a diagram. Initially I wrote instructions, which were about as helpful as sign language to a blind person. Then I made photo-diagrams, but this was back when phone cameras made everything look like a bigfoot sighting, so they were no good either. Eventually I resigned myself to learning how to make a digital diagram. I went on the still fresh, still fun YouTube and found instructions for a program that could help me. And in a similar fashion to my initial foray into origami design, I watched half the video, decided I knew what I was doing, and churned out sub-par instructions. I hope my diagramming has improved as much as my designs, otherwise the next hundred pages are going to be a little awkward.

Now, considering the word origami comes from the Japanese "oru," meaning to fold, and "kami," meaning paper, you'd think any product with "KAMI" splayed across its packaging would be some high quality stuff. Turns out, most of what is sold under the name kami is about one step above loose-leaf. This was the second problem I faced when trying to make diagrams of my designs. What good would a digital representation be when the real life version wasn't at its full potential? And since I took several hiatuses from origami over the years, I never organically developed the need for better paper. I just hit a wall. Thankfully, while posting yet another model to be scrutinized, someone sent me a link to a video. In it, they showed how to combine tissue paper and aluminum foil into the *cleverly* named tissue foil. This changed everything. Not only was I able to give my models the Cinderella transformation they deserved, I could use more advanced techniques without the paper tearing.

Now the last issue I had with diagramming was rather simple. Around the time people began requesting diagrams, I had about forty models made. Of those, people thought

## The Bases of Folding

about ten or so designs were interesting. On top of that, the number of models *I* actually liked could be counted on one hand, even if I lost a few fingers. I thought to myself, what would be the point in learning how to diagram if I had no models I *wanted* to diagram? So I got to folding, trying to satisfy my own rising standards. Most of the time, even today, my designs are hit or miss. I've wasted enough paper to fill a storage container, and unfortunately have had to give up on one or twenty design ideas because they were still beyond my capabilities. The road to improvement is winding and thorny, but origami is just as much about the journey as it is the destination.

Part of that journey is embedded into this book. It took me almost a decade to make the collection I've cataloged in these pages. Some took that entire time to come to fruition, some are second or seventh attempts gone right, and some were flashes of inspiration and feverish folding. But all of them were models I was unsure of, pieces I posted online wondering whether or not people would like them as much as I did. Wondering whether I could make something that I would be happy to fold and that I would be happy while folding. Other folders have been more than happy to tell me what works and doesn't work for them. So this book is not just the best of what I had to offer, but also a thank you to the community that has helped me grow.

I'm sure there are more than a few people wondering why I basically told you my life story. That's because, for the most part, origami *is* my life story, interwoven into my very history. Through major events, triumphs and failures, and even times when I was just sitting around, bored or absentminded, I had a piece of paper in my hands. The very reason this book is free is because of my childhood assumption that origami artists shared their works, because of my teenage desire to give people a book they could download guilt-free, and because of my grown-up appreciation of what has helped shape me into who I am today.

In the end, origami is not just a hobby. It's a way of seeing the world, a way of learning and growing. The title is a play on this. First, I love a good pun, so you may notice quite a few of the models in this book use a traditional base. Second, and more importantly, every model in this book begins with something I learned about life while folding, some small insight into the design process, or just something introspective and interesting. These are the bases of folding, the foundations upon which origami as an artform, and as a way of life, are built. They are just some of the reasons I believe origami is worth learning, worth creating, and worth sharing with all of you.

# Table of Contents

Poem . . . . .	1
Introduction . . . . .	2
Table of Contents (You Are Here!) . . . . .	5
Guidelines . . . . .	7
Snail . . . . .	11
Mouse . . . . .	14
Duck . . . . .	17
Manta Ray . . . . .	21
Sea Turtle . . . . .	25
Firefly . . . . .	29
Brittle Star . . . . .	33
Clam . . . . .	38
Shrimp . . . . .	43
Goldfish . . . . .	47



<b>Bat</b> . . . . .	<b>54</b>
<b>Dolphin</b> . . . . .	<b>60</b>
<b>Shark</b> . . . . .	<b>66</b>
<b>Seahorse</b> . . . . .	<b>76</b>
<b>Sheep</b> . . . . .	<b>83</b>
<b>Octopus</b> . . . . .	<b>94</b>
<b>Lion</b> . . . . .	<b>100</b>
<b>Wolf</b> . . . . .	<b>108</b>
<b>Crab</b> . . . . .	<b>112</b>
<b>Blobfish</b> . . . . .	<b>121</b>
<b>Superb Bird of Paradise</b> . . . . .	<b>126</b>
<b>Bacteriophage</b> . . . . .	<b>143</b>
<b>Minimal Fox</b> . . . . .	<b>152</b>

# Diagram Guidelines (and Guidearrows)







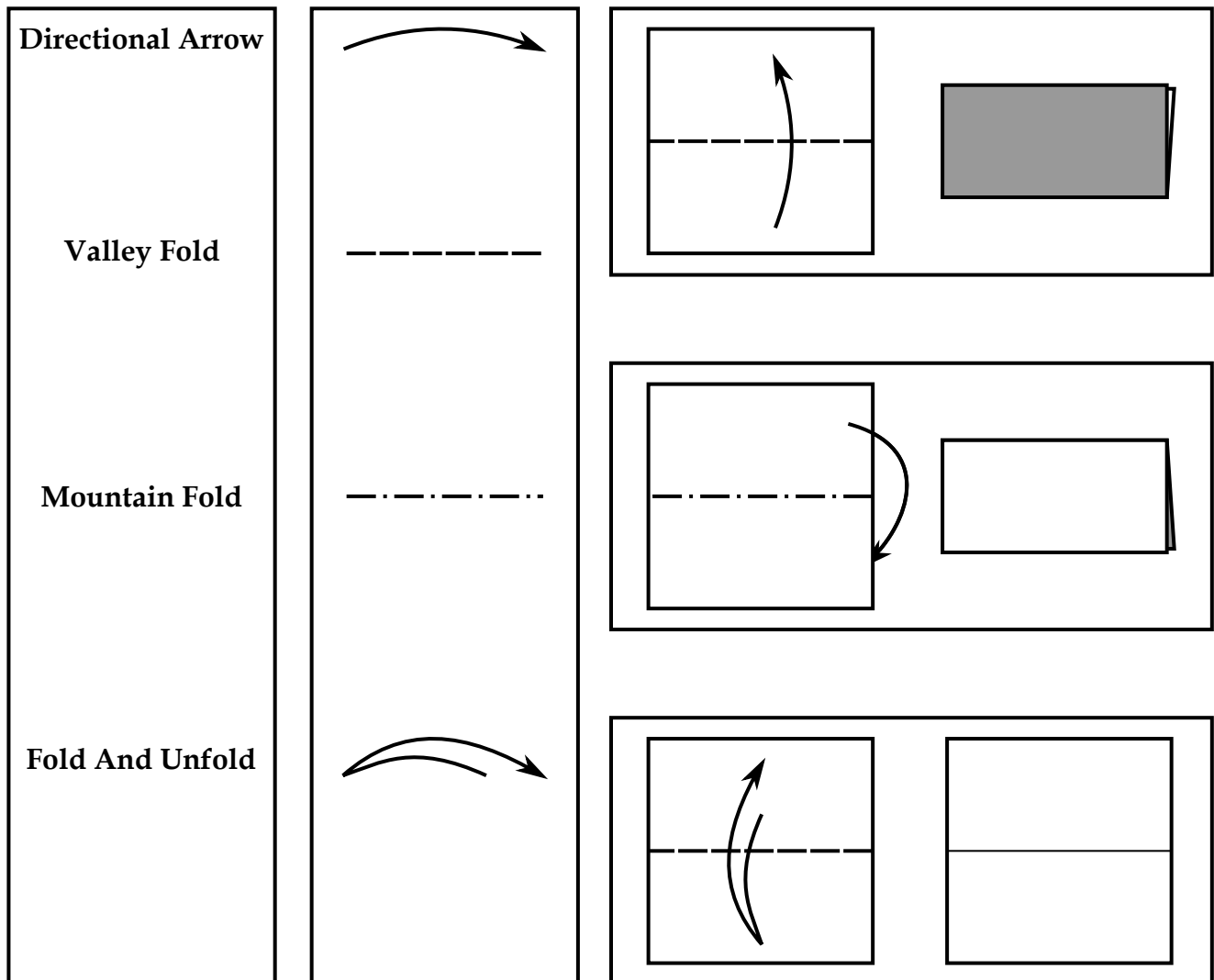

*Within the Sonnet's scanty plot of ground;  
Pleased if some Souls (for such there needs must be)  
Who have felt the weight of too much liberty,  
Should find brief solace there, as I have found.*

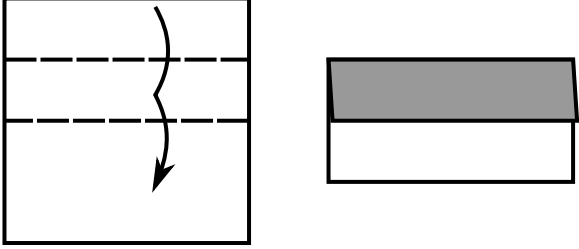
-William Wordsworth

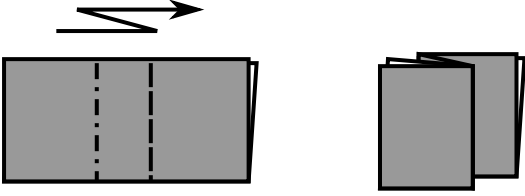

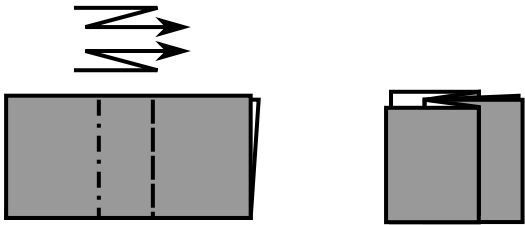
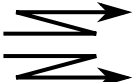
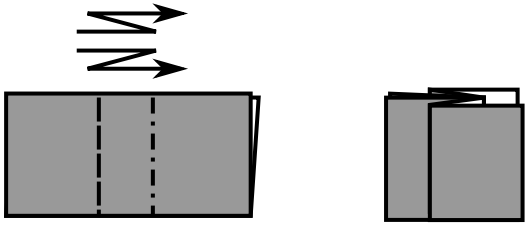

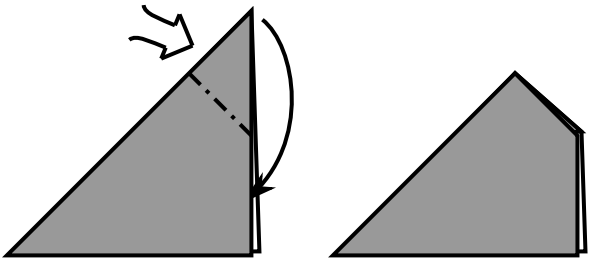

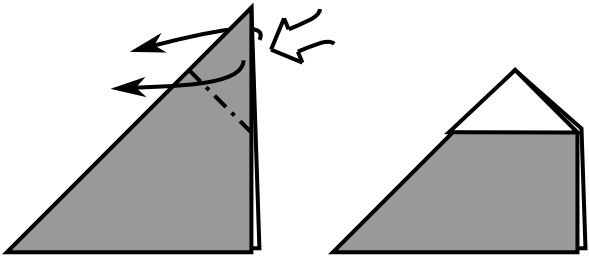

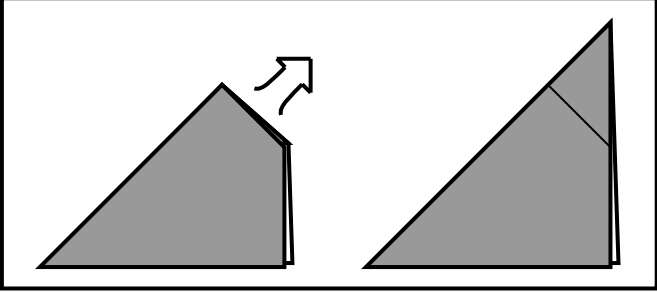

Rules do not restrict art; in fact it is quite the opposite. When origami grew in popularity, the need for a uniform set of symbols arose. Even the simplest of techniques would be difficult to understand if no one could agree on how it should be put to paper. Thankfully, through the prolific works of Grandmaster Akira Yoshizawa, the framework of origami diagrams was accepted worldwide, with each new generation of artists building upon this system. It is that culmination of effort you'll see used in this book.

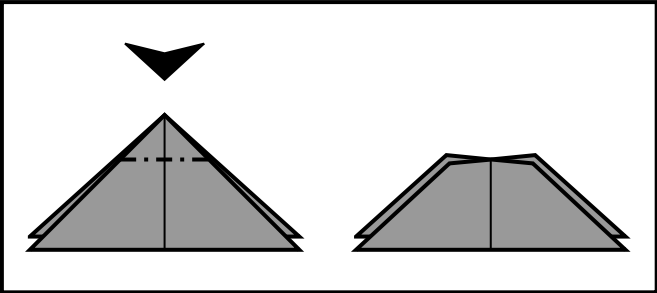

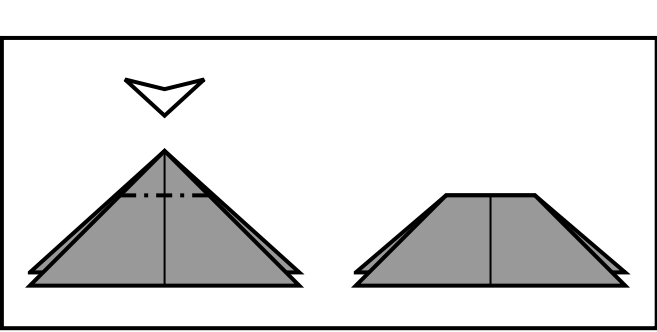
# The Bases of Folding

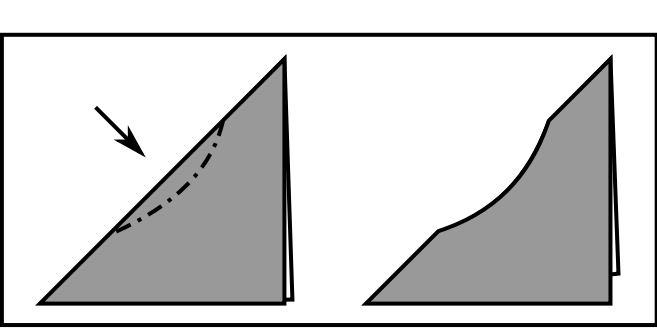
<p>Successive Folds</p>		
<p>Pleat Fold</p>		
<p>Inside Crimp Fold</p>		
<p>Outside Crimp Fold</p>		
<p>Inside Reverse Fold</p>		
<p>Outside Reverse Fold</p>		

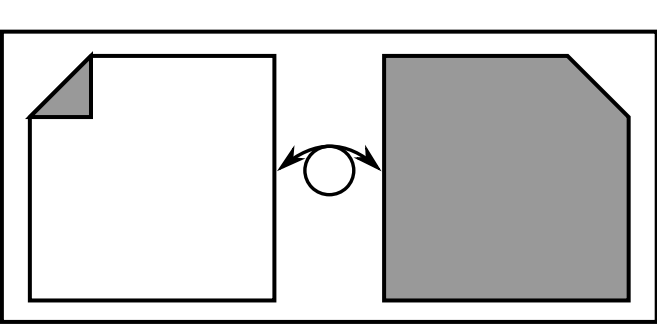
# The Bases of Folding

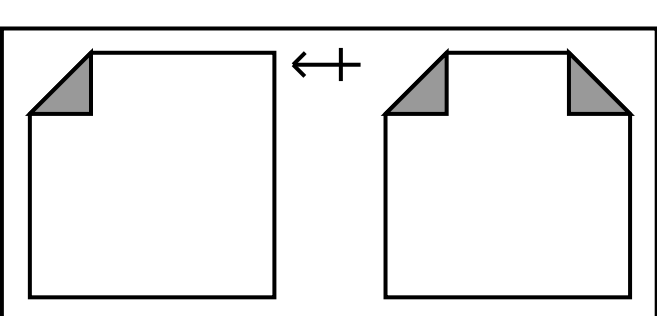
<p><b>Internal Reverse Fold</b></p>		
<p><b>Open Sink Fold</b></p>		
<p><b>Closed Sink Fold</b></p>		
<p><b>Move/Shape Arrow</b></p>		
<p><b>Turn Model Over</b></p>		
<p><b>Repeat Step(s)</b></p>		

## The Bases of Folding

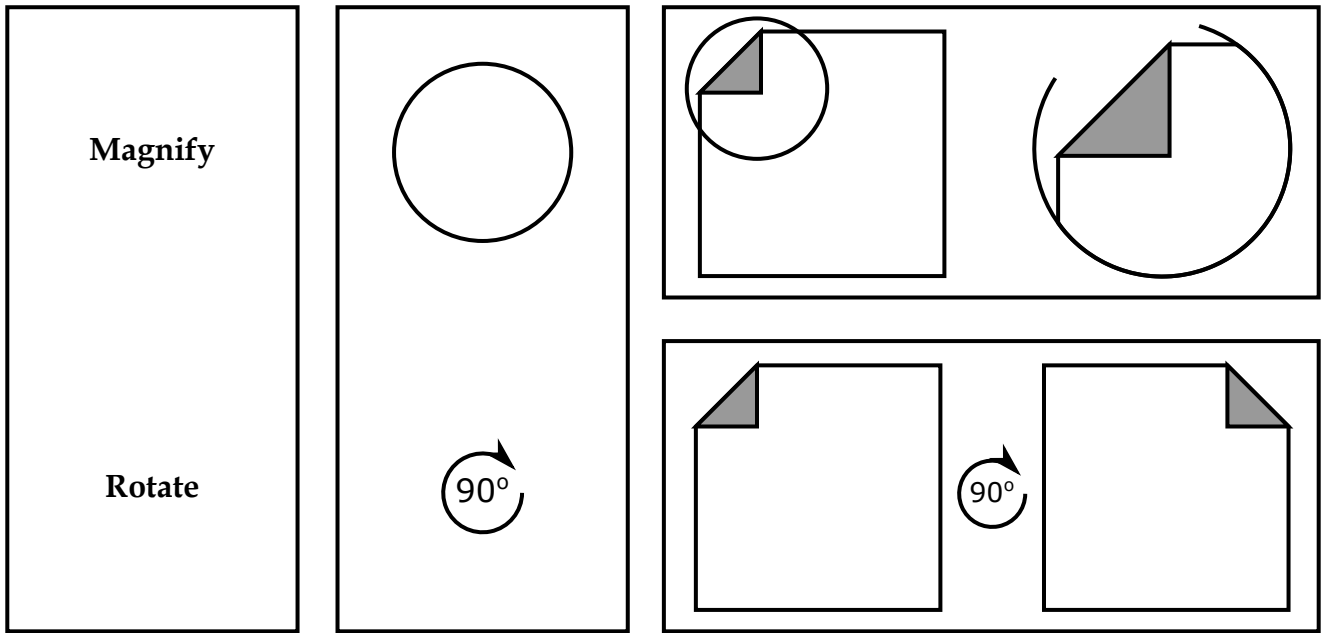

## Cuts

While cutting paper was frequently used in traditional origami (a topic we will be exploring in this book), it has become taboo in modern practice. The exception to this is cutting a square into a polygon, a rectangle, or a half square triangle.

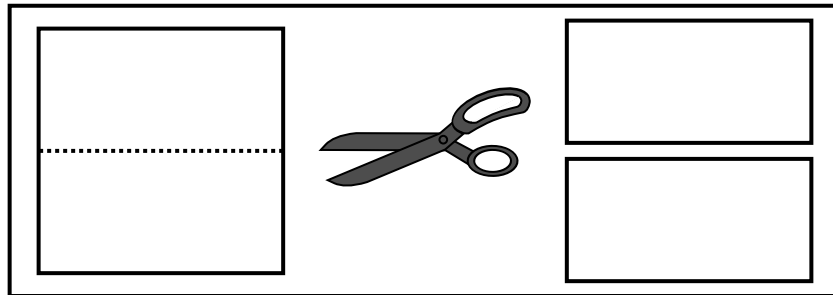

## Following Along

Origami guidelines are generally agreed upon; page layout isn't. Some people use numbers, some use words. Some even have you follow the yellow brick road.

The following diagrams are old fashioned, with no added bells or whistles. They are simply read left-to-right, top-to-bottom. I wanted to make sure the steps took up the whole page, with nothing else to distract from the models.

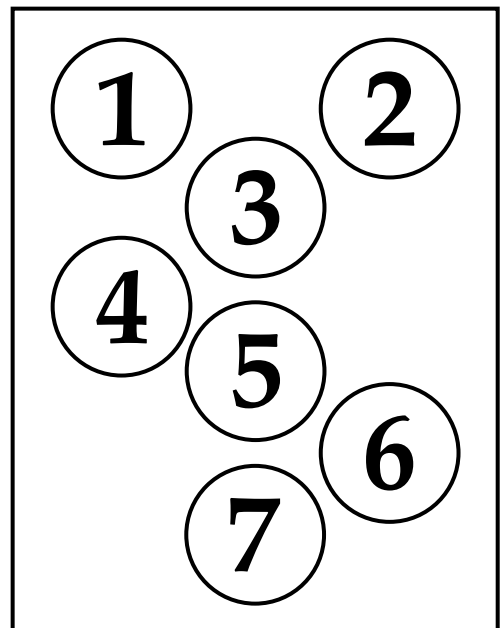

# Fanciful Snail

How do you set yourself apart from other people? If everyone is staring at the same bowl of fruit, how is it that each portrait is different?

The trouble with this line of questioning is that it takes the individual out of the equation. What each person creates is different because it contains that person's unique perspective, something that cannot be replicated.

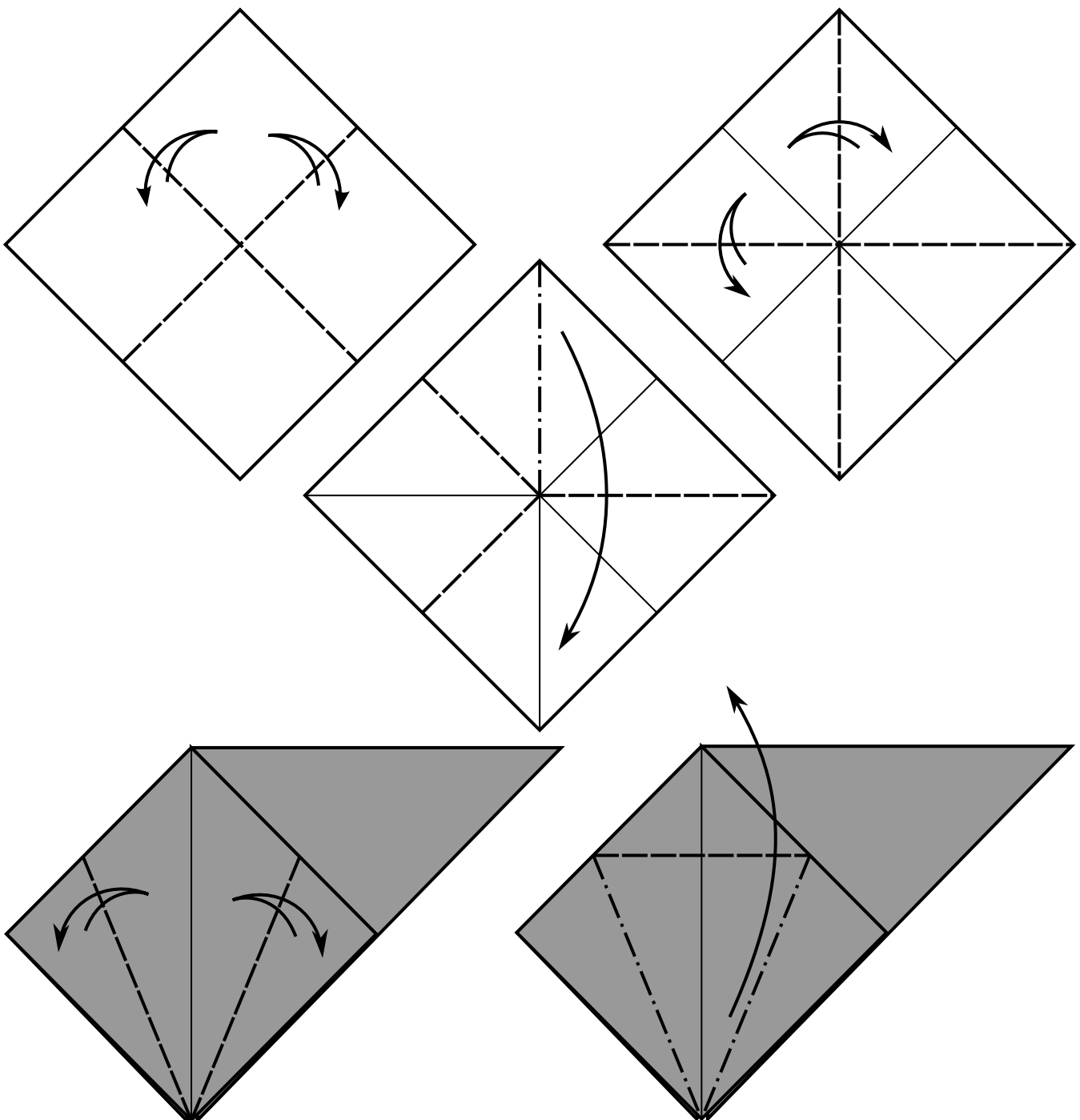

# The Bases of Folding

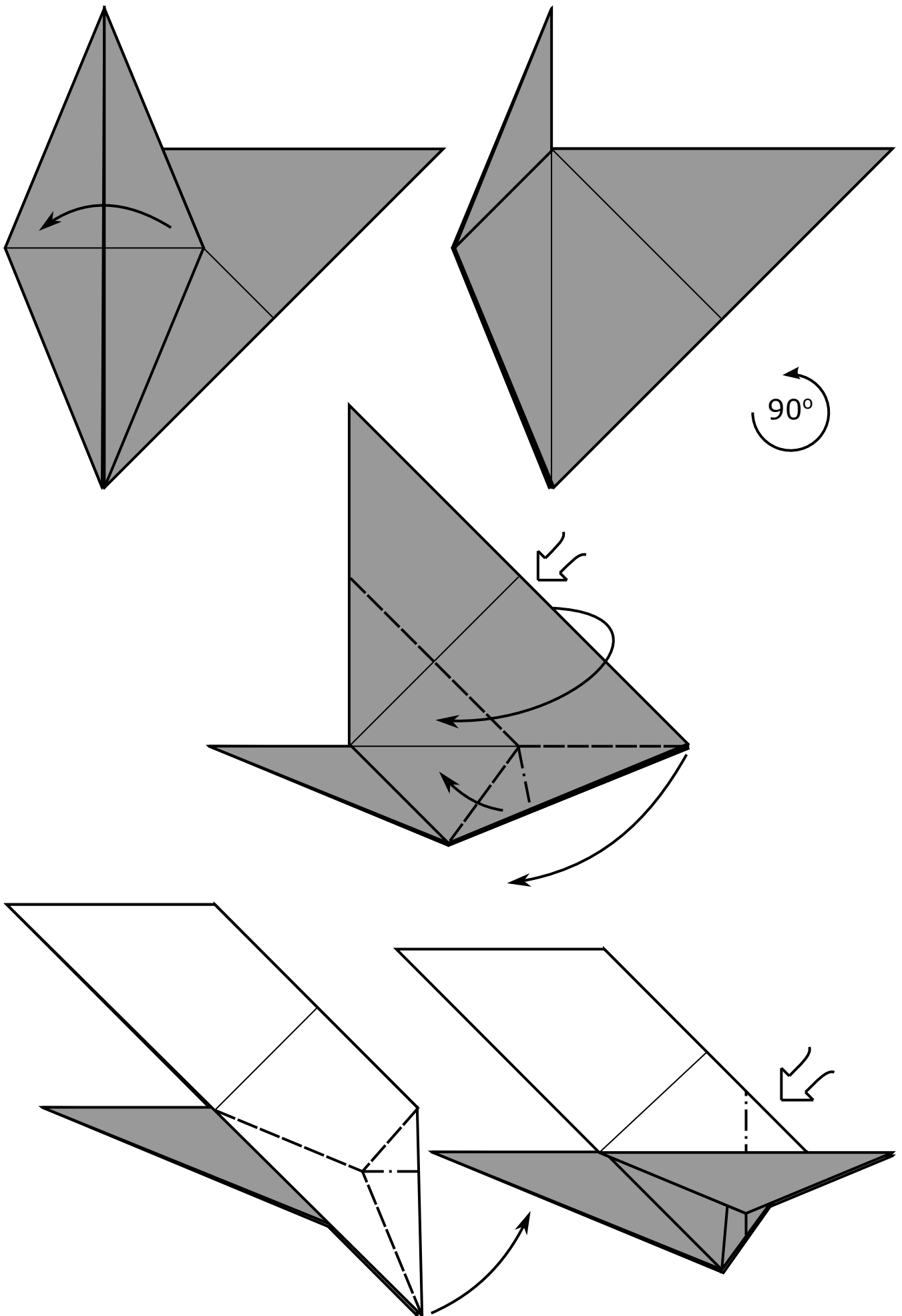

# The Bases of Folding

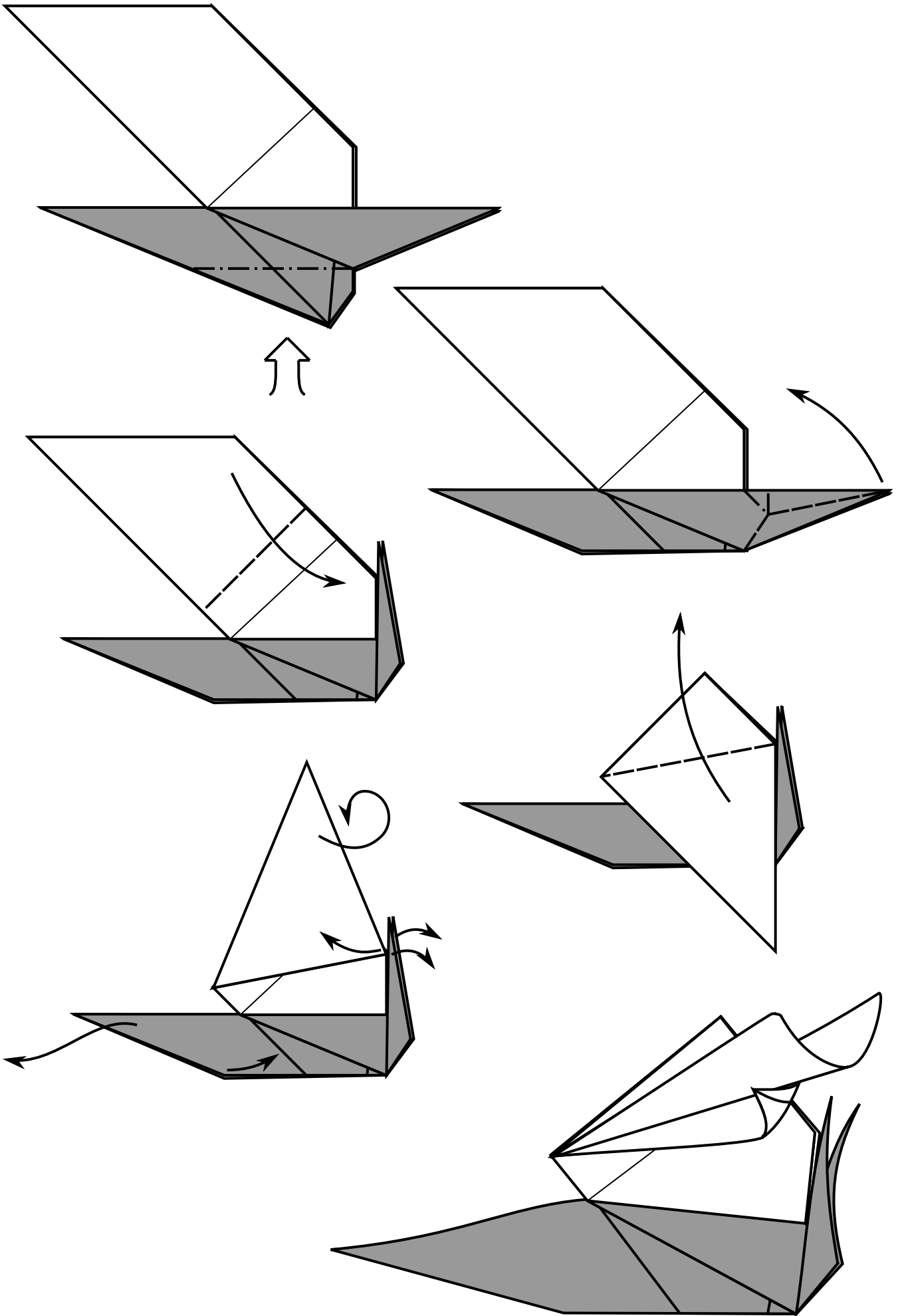



# MOUSE

Sometimes things don't turn out the way you hoped, but that doesn't have to be such a bad thing. Time is often all you need to appreciate what is, rather than what could have been.

I really didn't like this design at first, but after the addition of the teeth and the shaping of the back, I found it far more endearing.

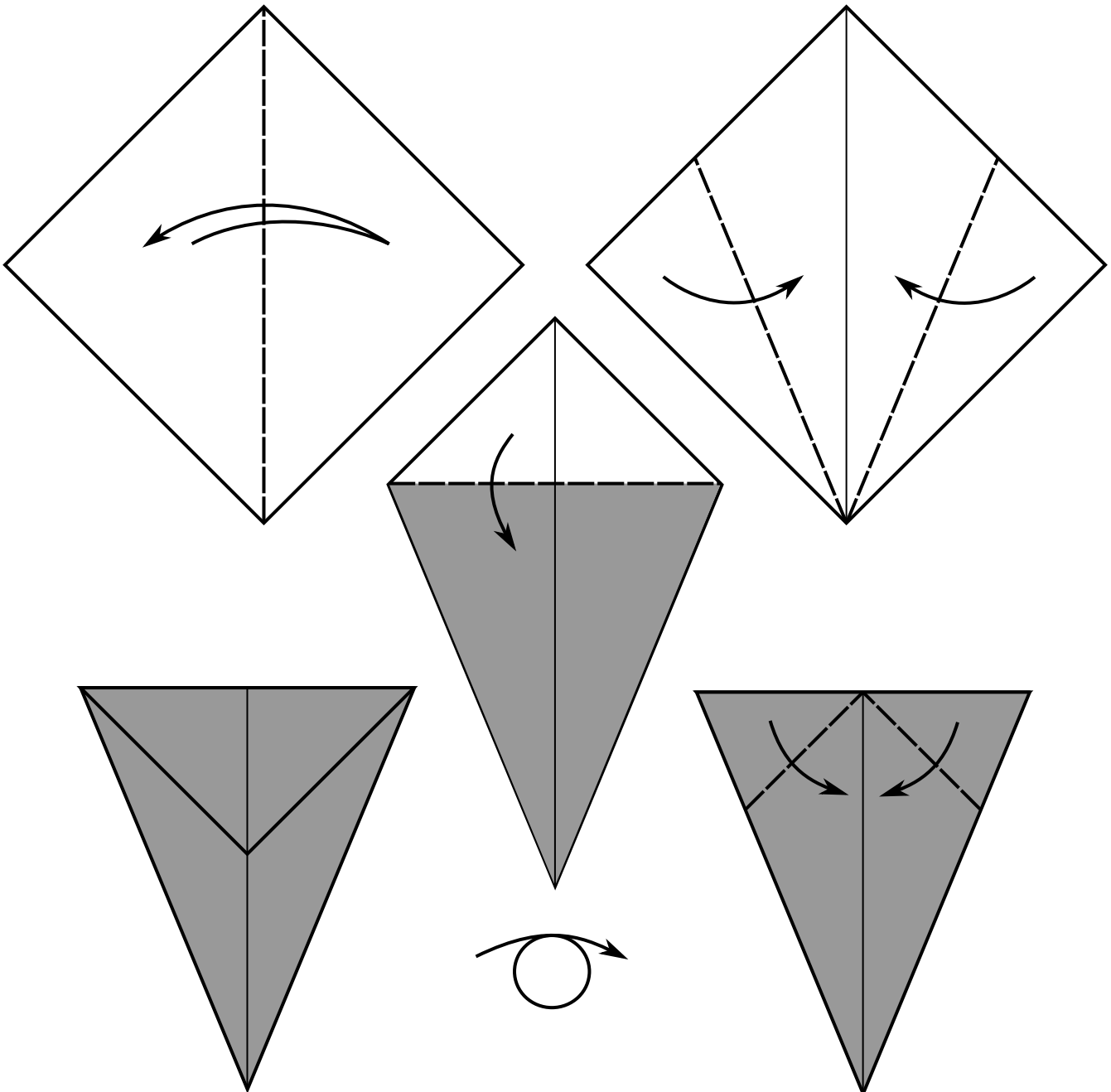

# The Bases of Folding

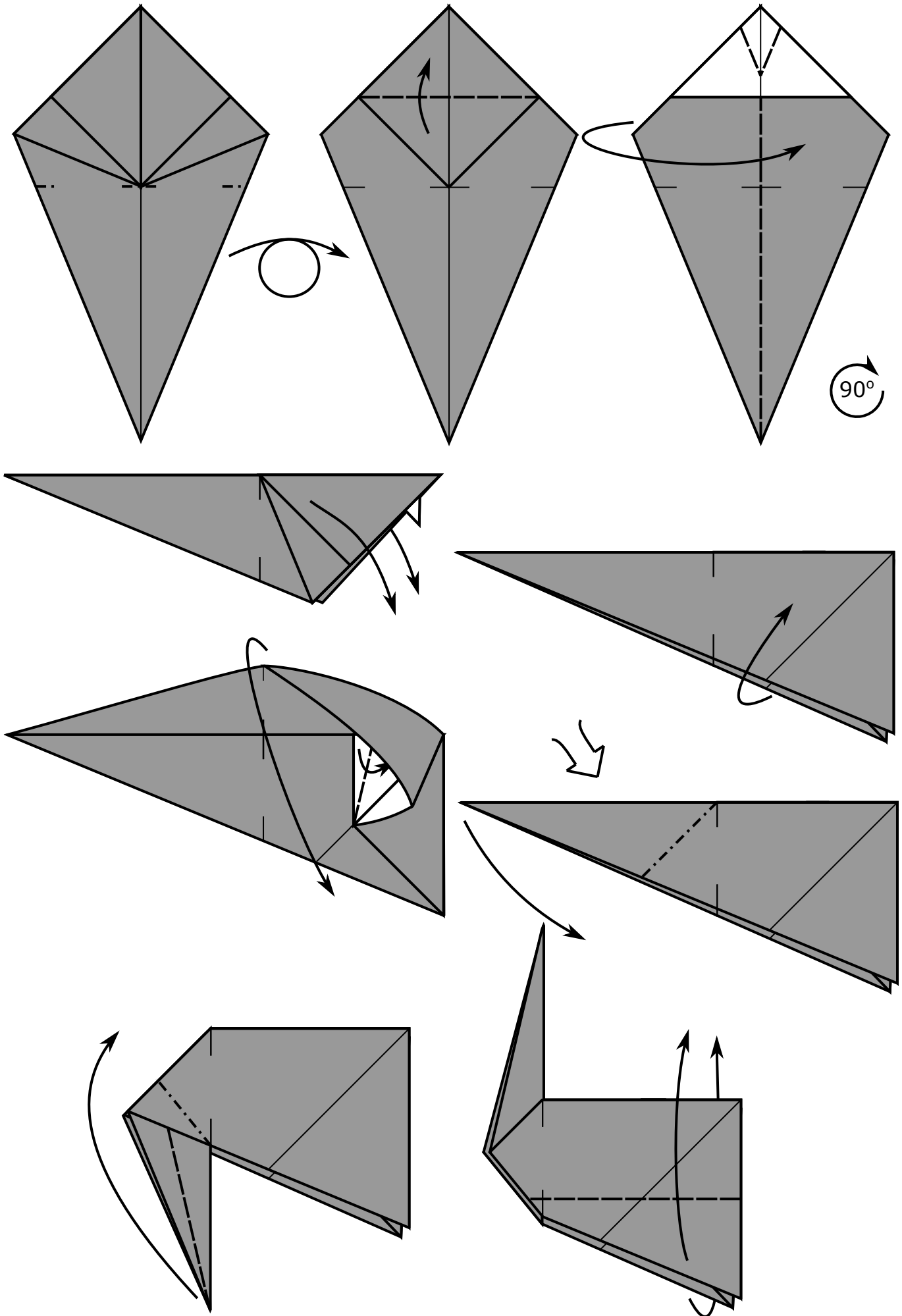

# The Bases of Folding

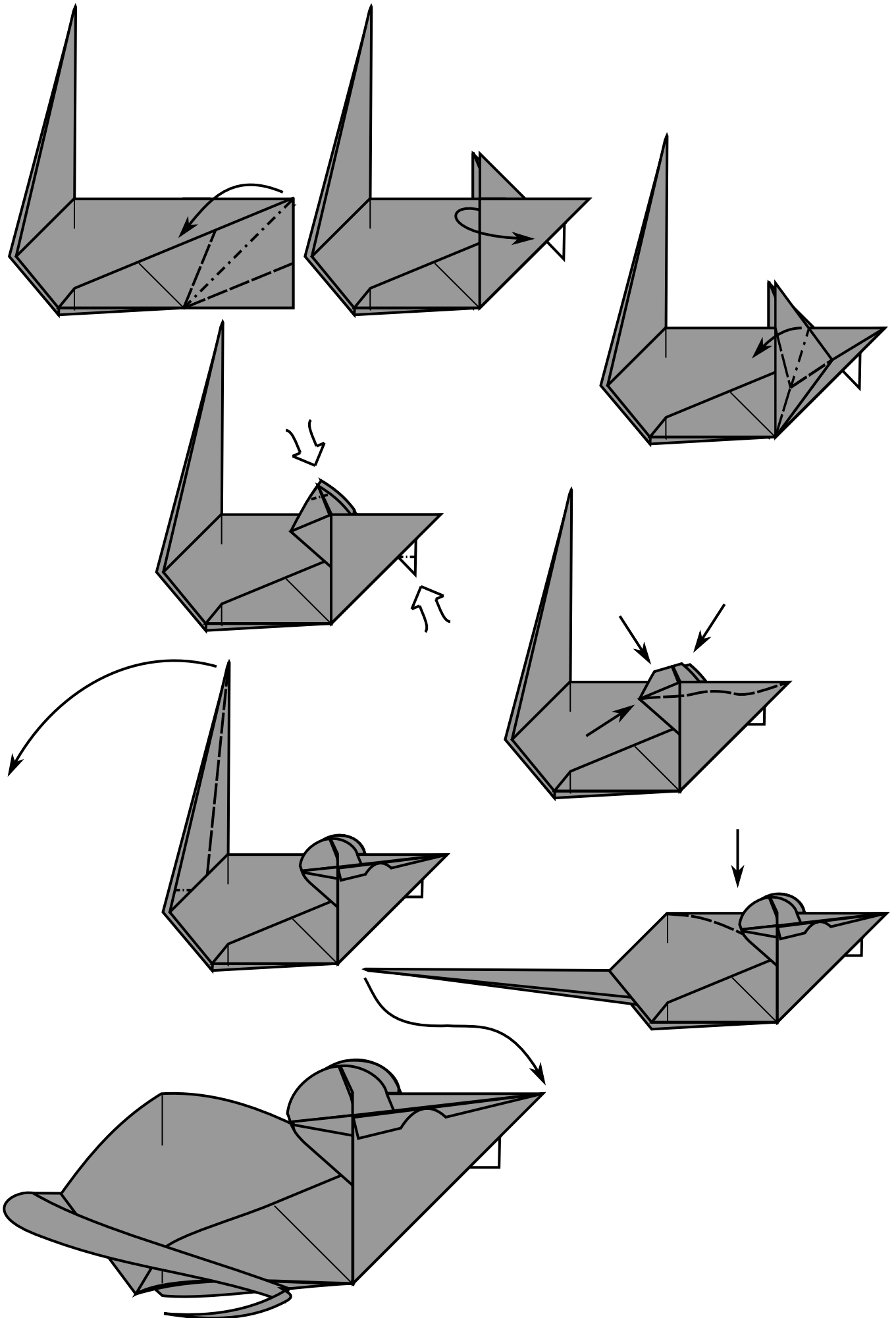

# Duck

Never be afraid to wait for inspiration. If something hasn't come to you yet, don't let frustration halt your potential success.

I couldn't figure out how to make a head that was both large enough and shaped correctly. After trying to add color, the new shaping fixed those problems.

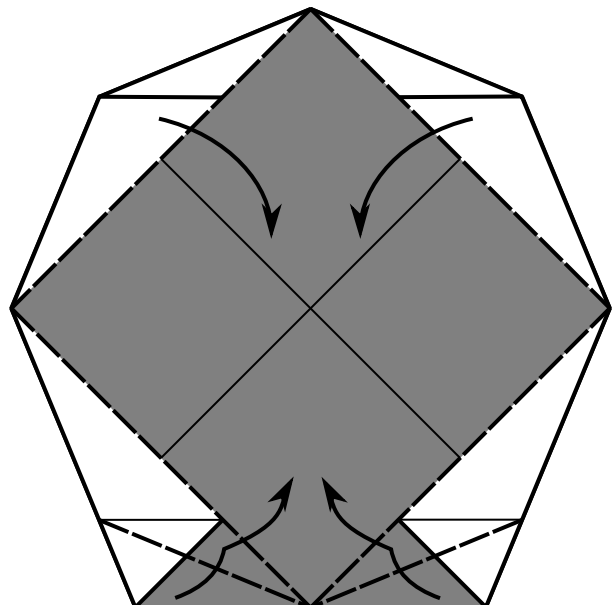
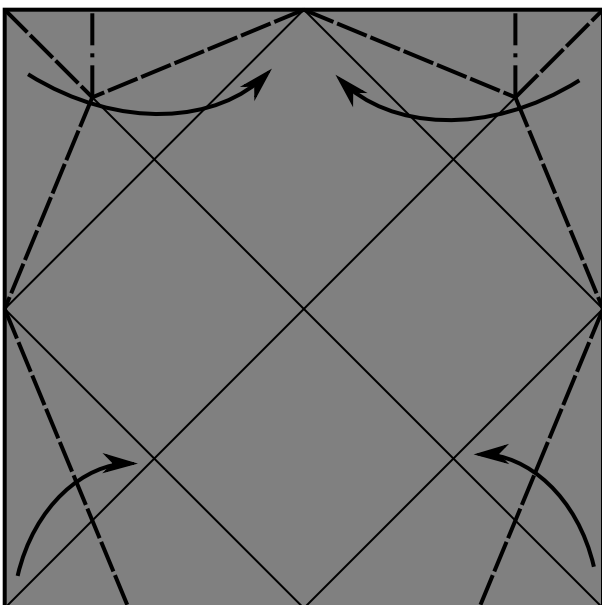
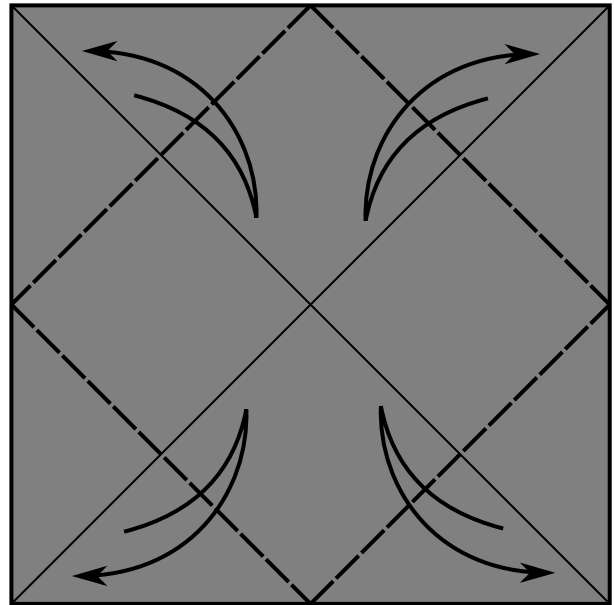
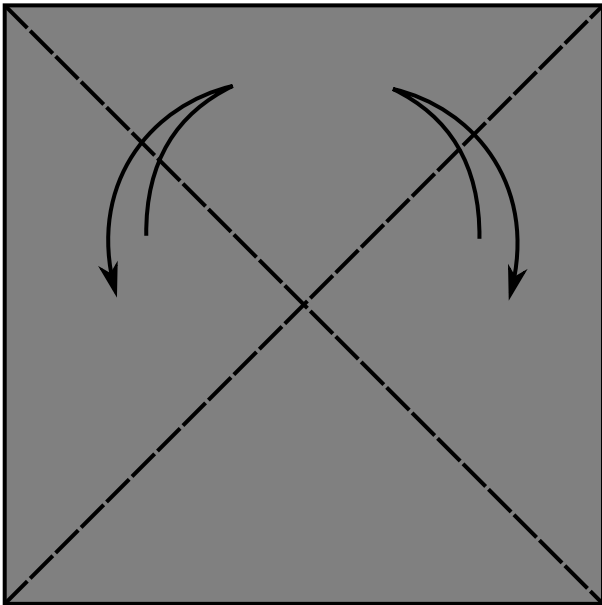

# The Bases of Folding

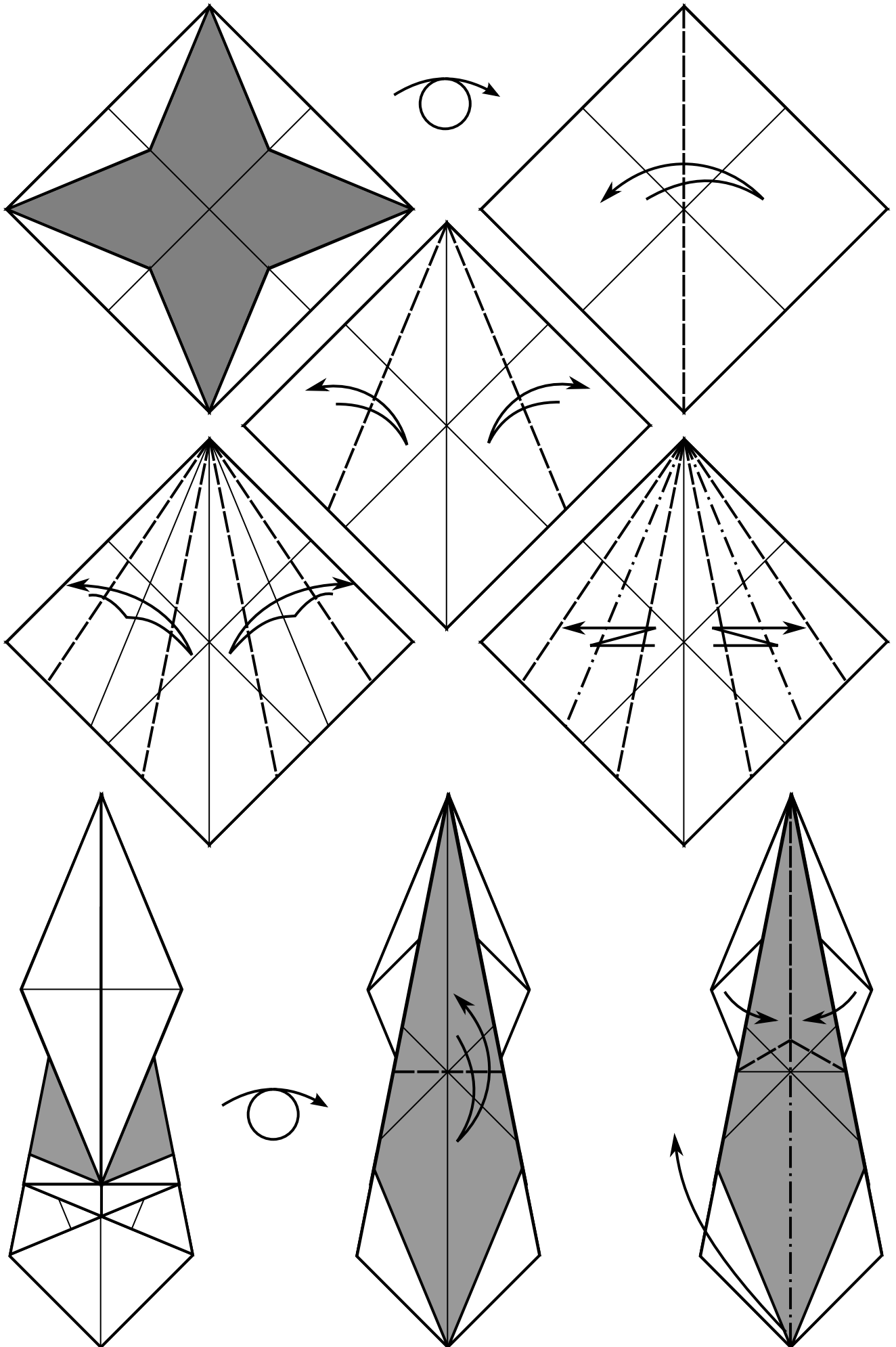

# The Bases of Folding

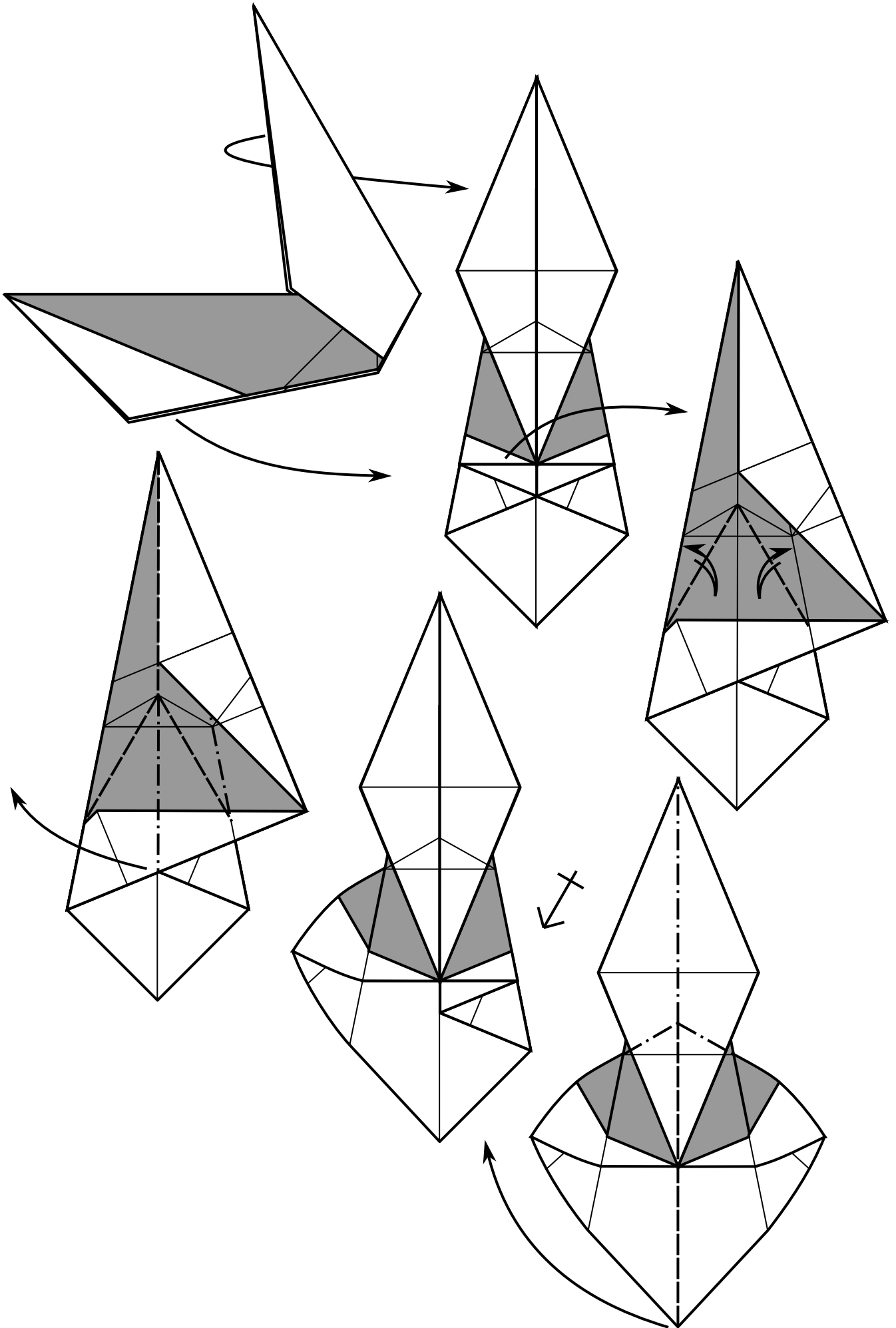

The Bases of Folding

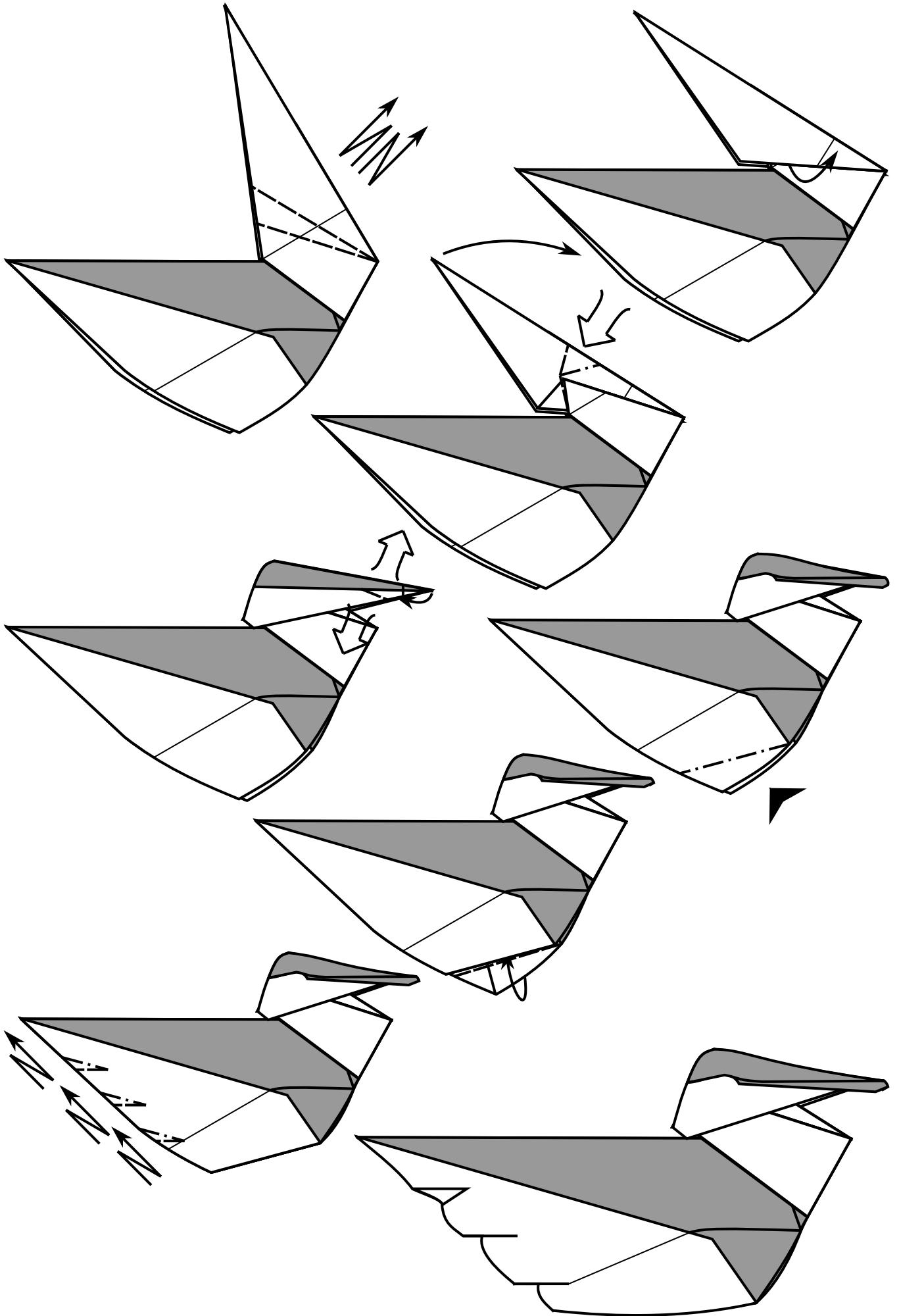

# Manta Ray

Even after years away, picking up where you left off is almost second nature, and your renewed energy will make what felt stale before feel fresh again.

This model was designed after a long hiatus, and had I not started folding again I wouldn't have felt the joy of making it.

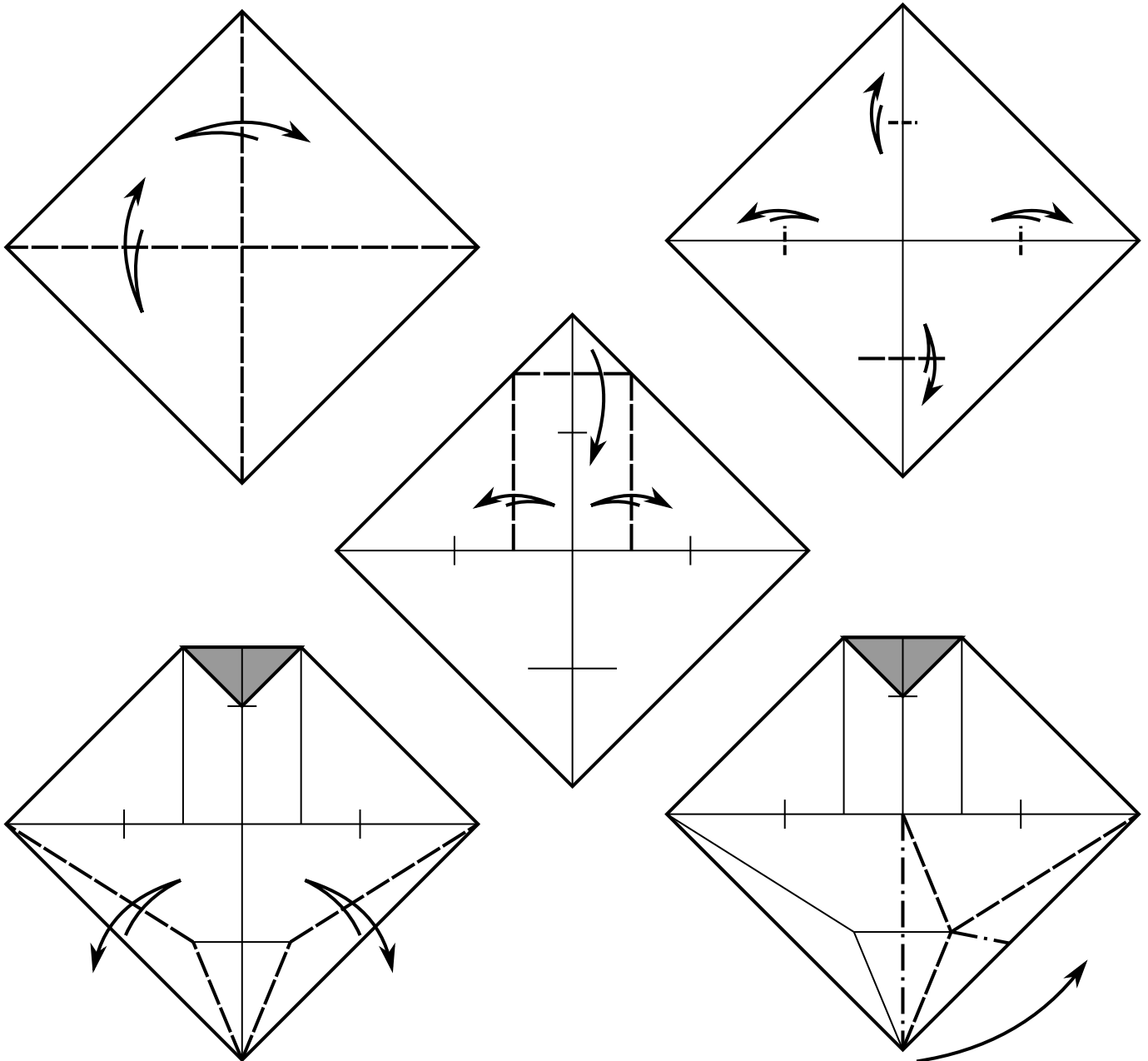



The Bases of Folding

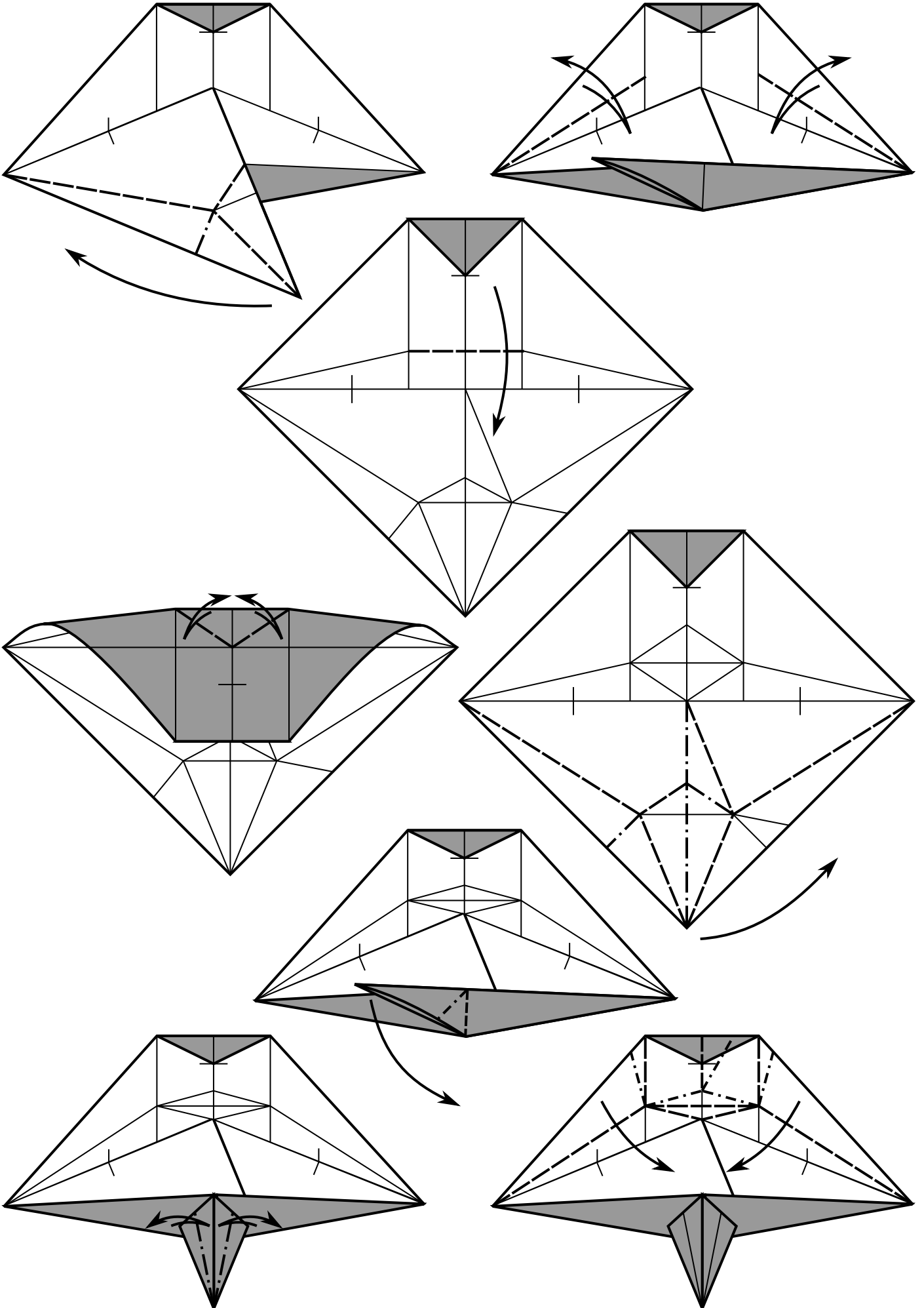

# The Bases of Folding

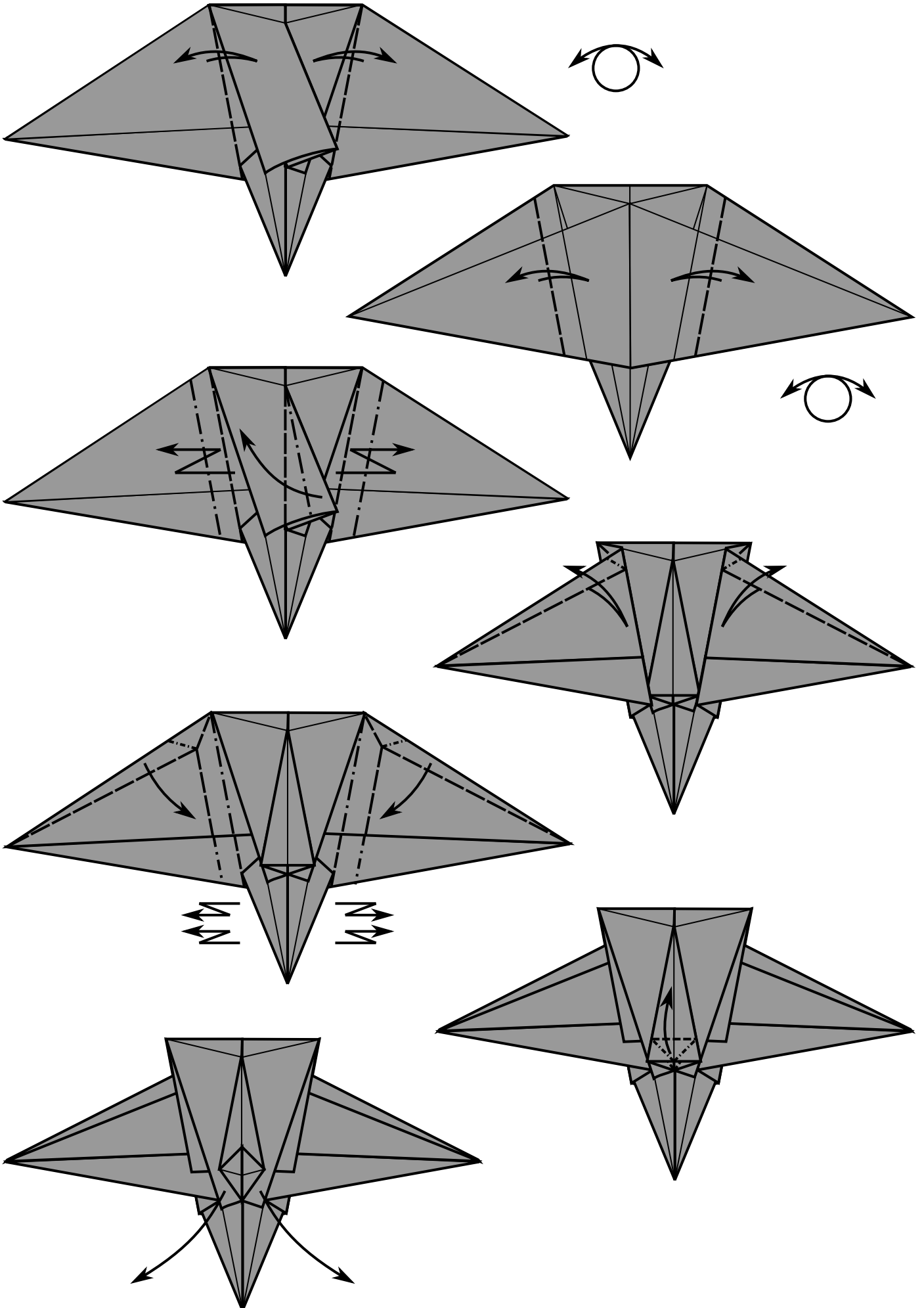

# The Bases of Folding

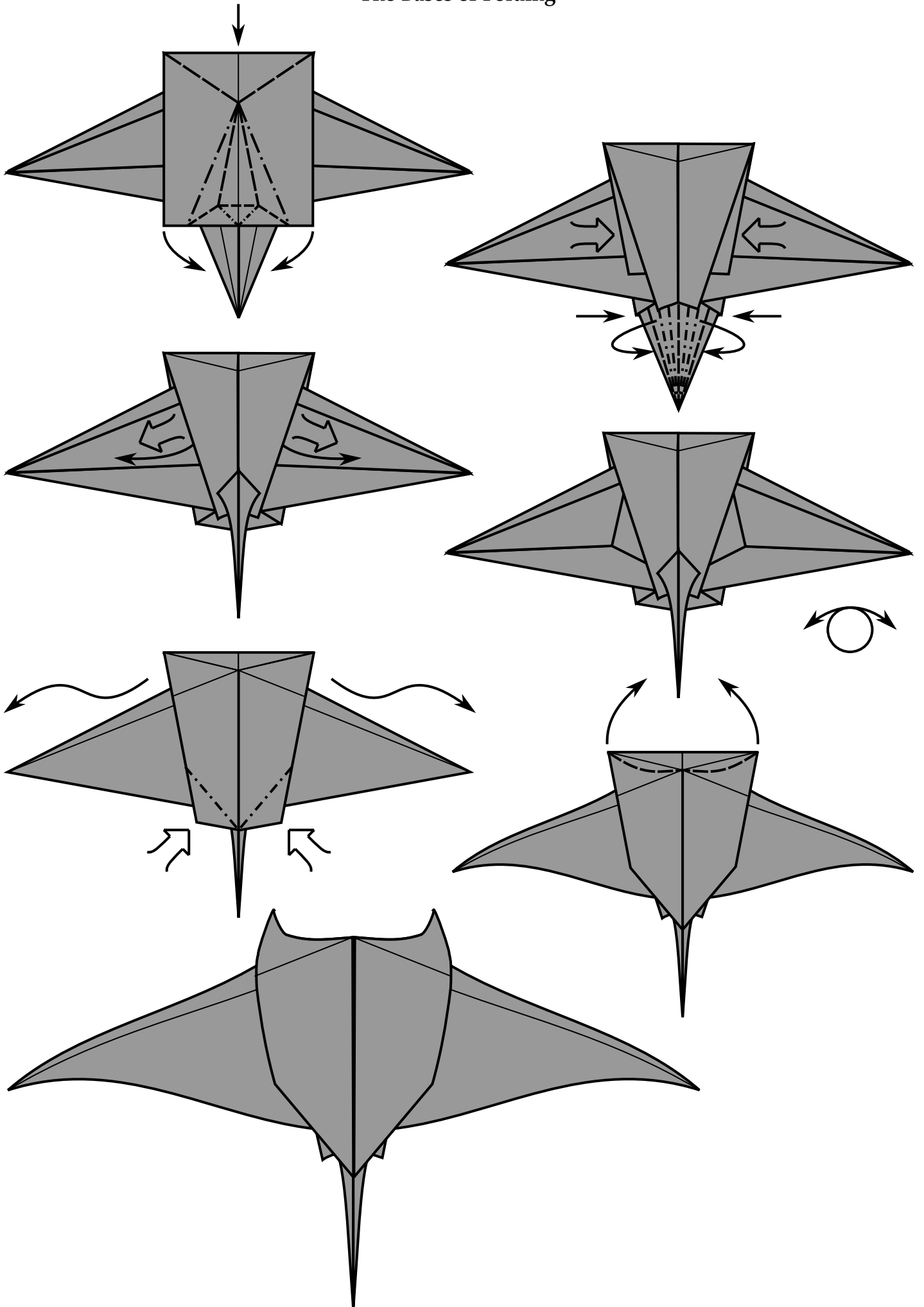

# Baby Sea Turtle

Pareidolia is the phenomenon by which people interpret recognizable objects from vague or incomplete references. Cloud gazing, astrological signs, and seeing faces on random objects are enjoyable instances of this.

You don't need every little detail in life to be perfect, and many times striving for such will only lead to unhappiness. Look around you, and see that simple things reveal a much bigger picture.

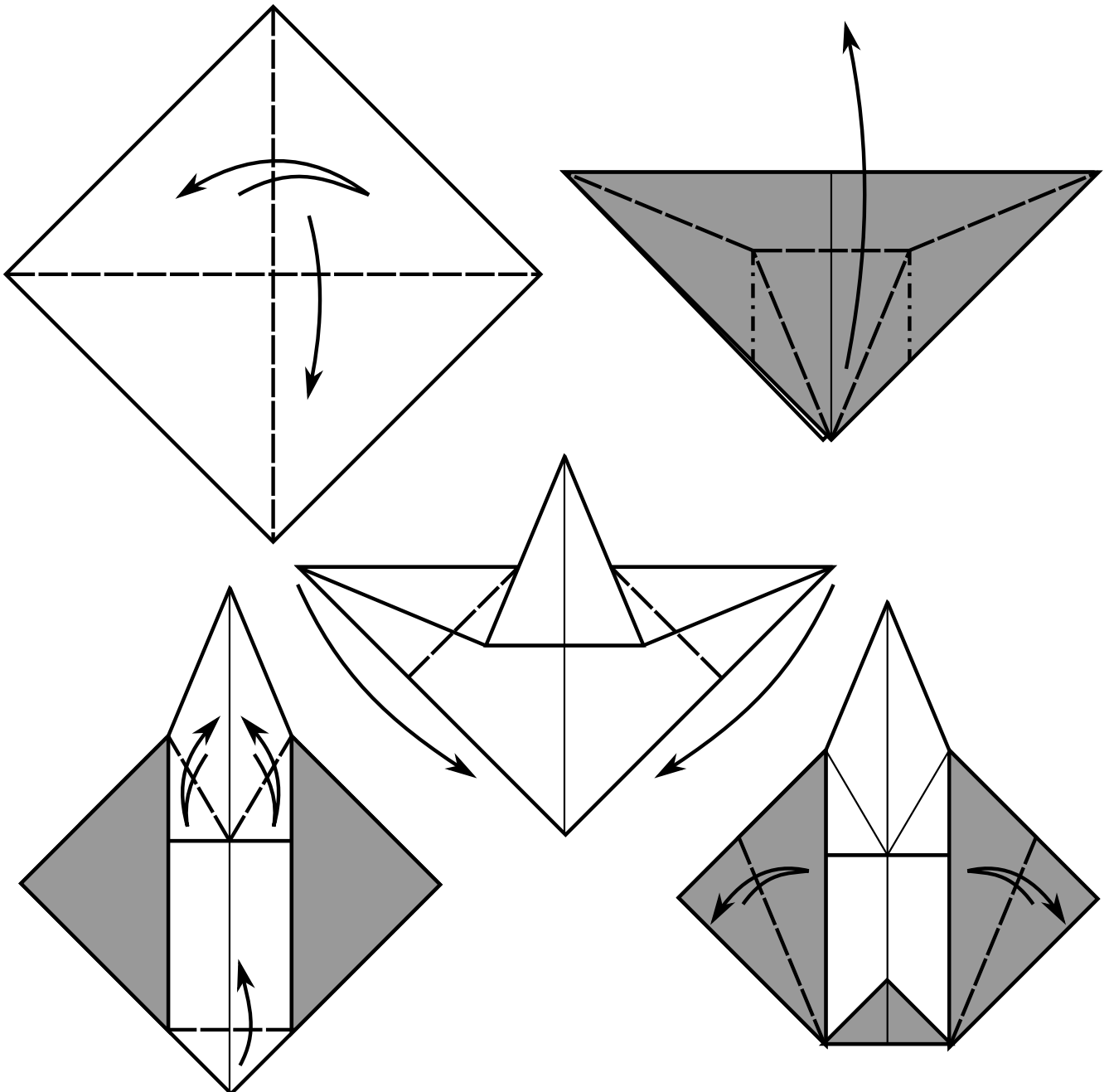
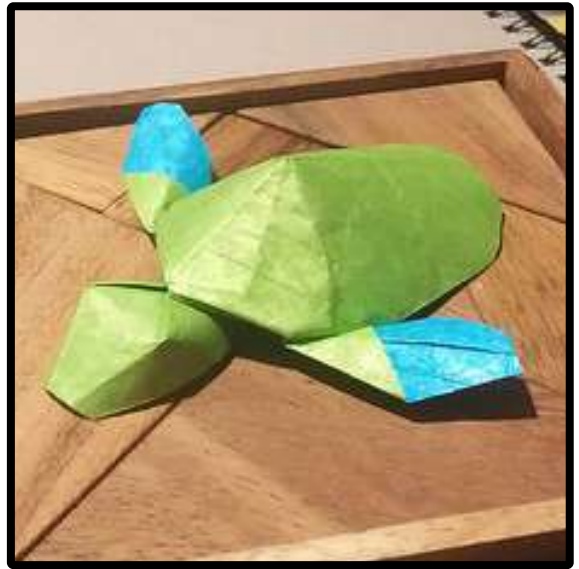

# The Bases of Folding

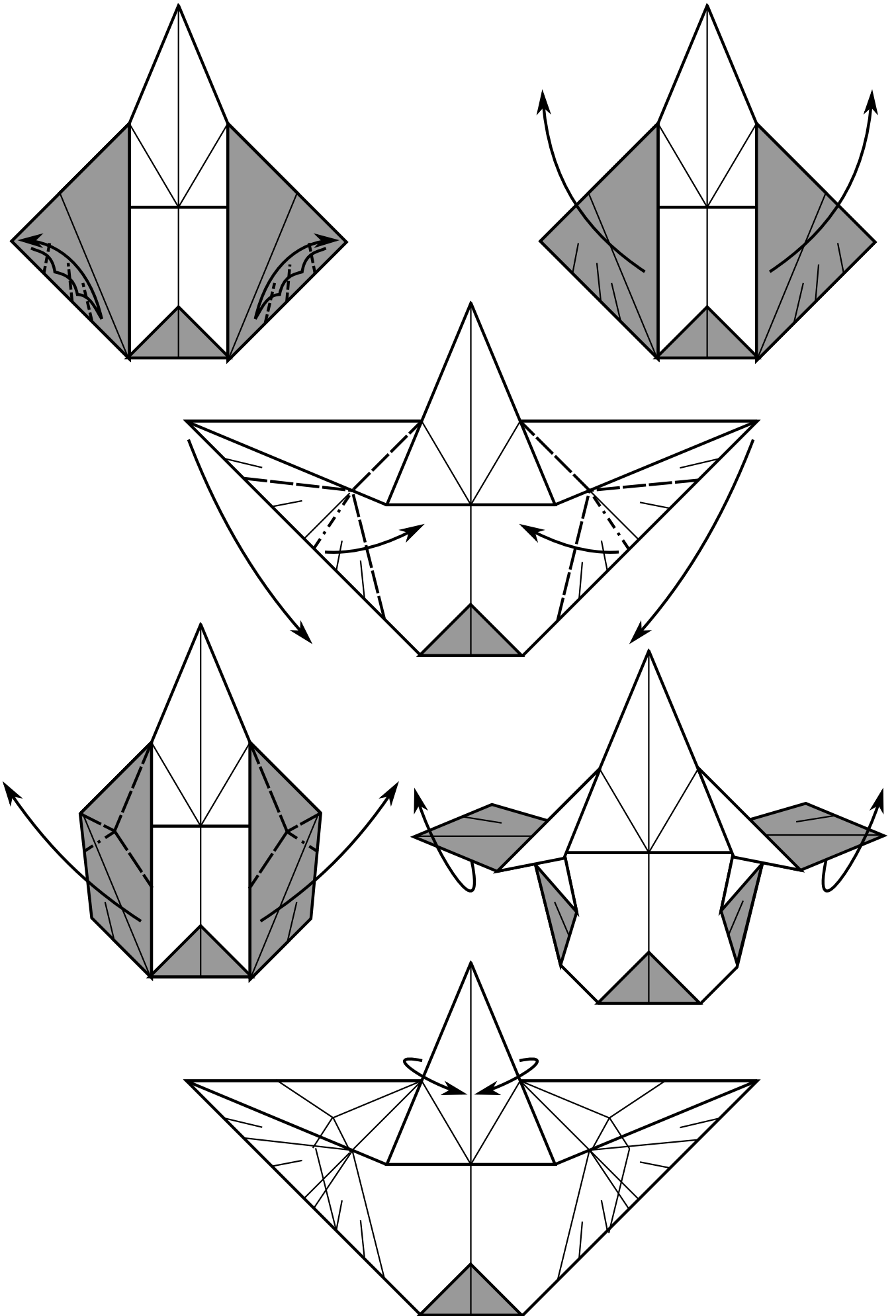

# The Bases of Folding

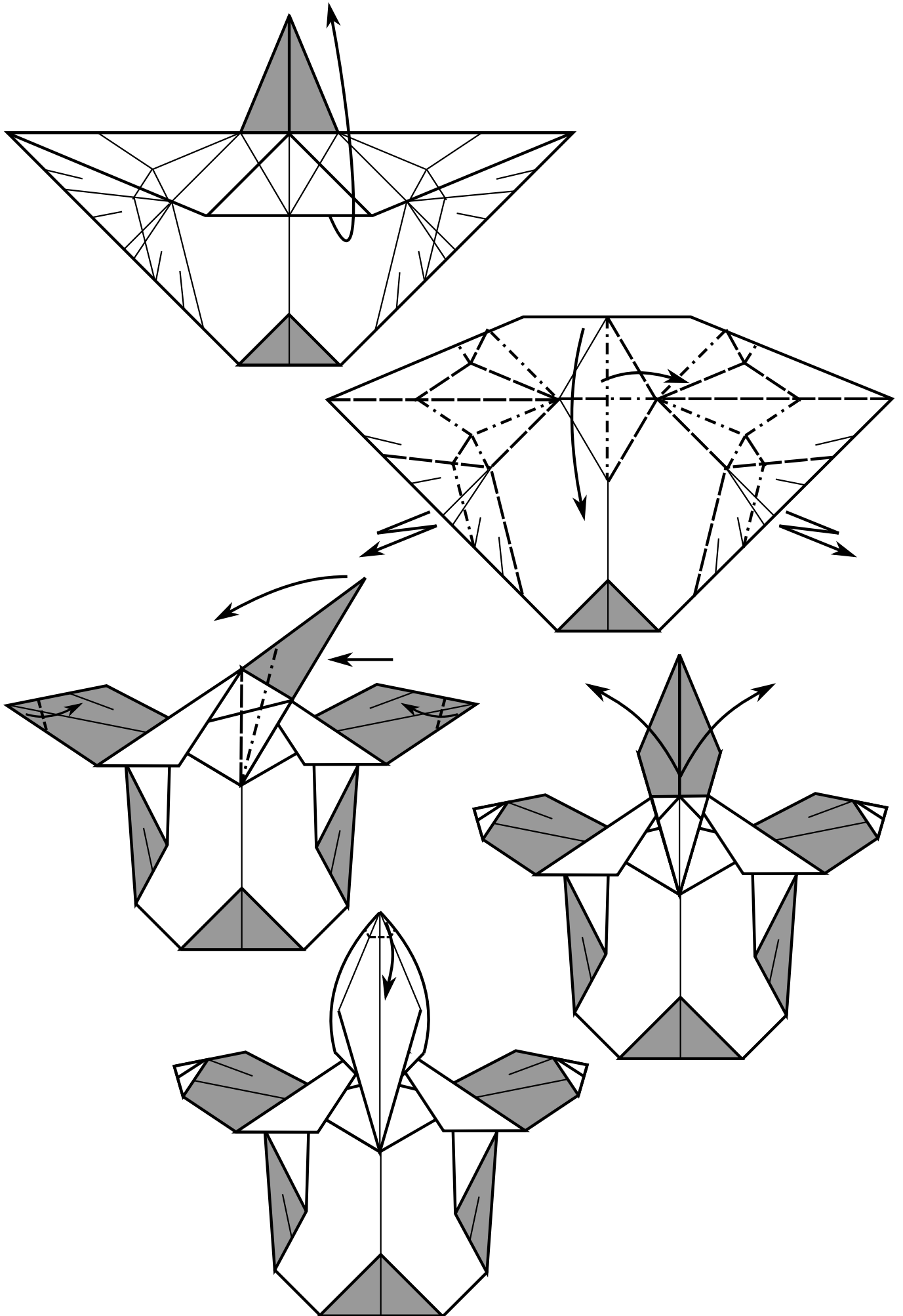

# The Bases of Folding

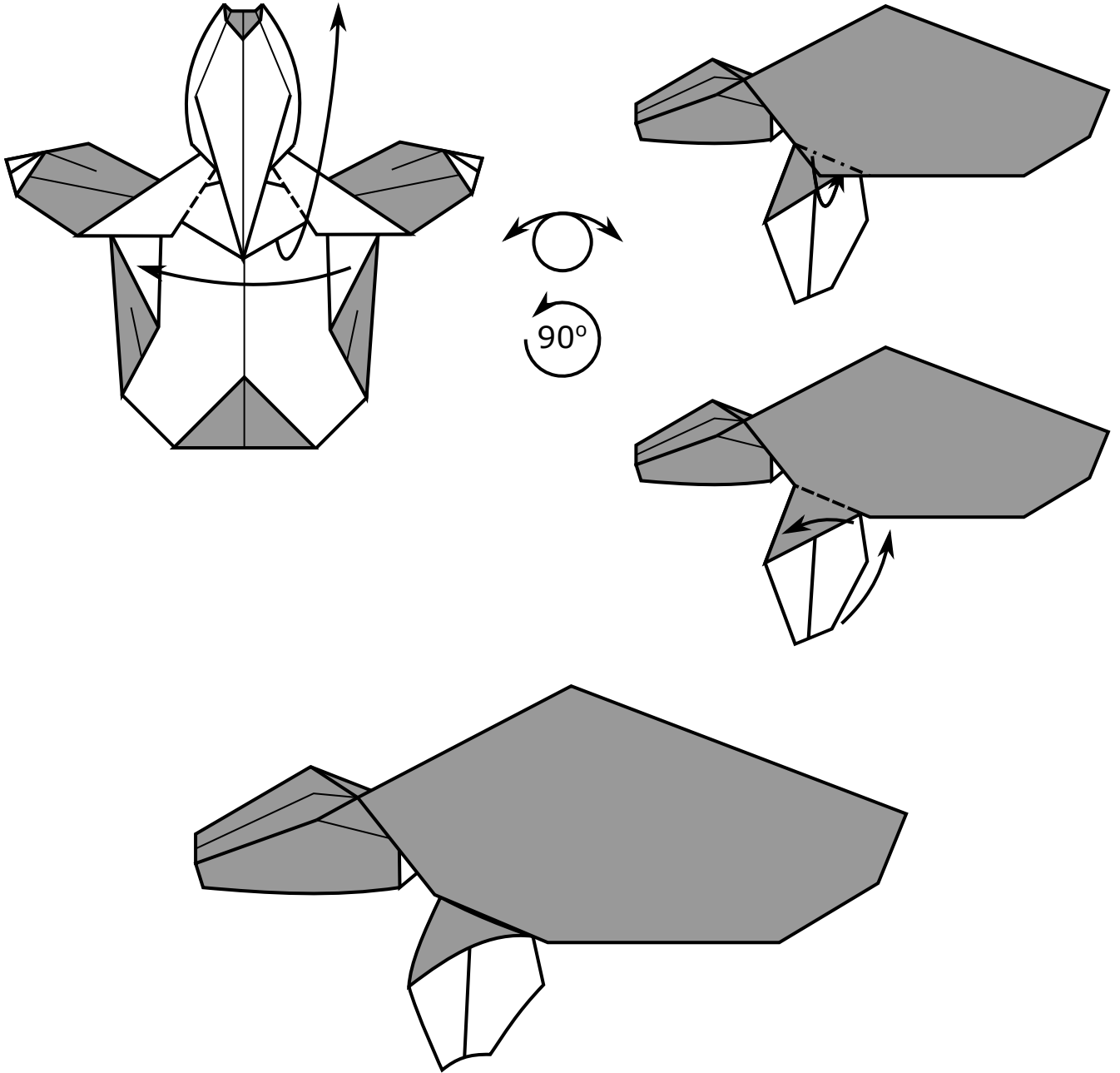

# Firefly

Life can often lead you in unexpected directions. Like chasing fireflies in the dark. One moment you're heading forward, and the next you've changed course, always follow that alluring glow.

I bought what I believed to be orange tissue paper to make a jack o' lantern. However, the paper was more gold than orange, so I ended up making a simple firefly instead.

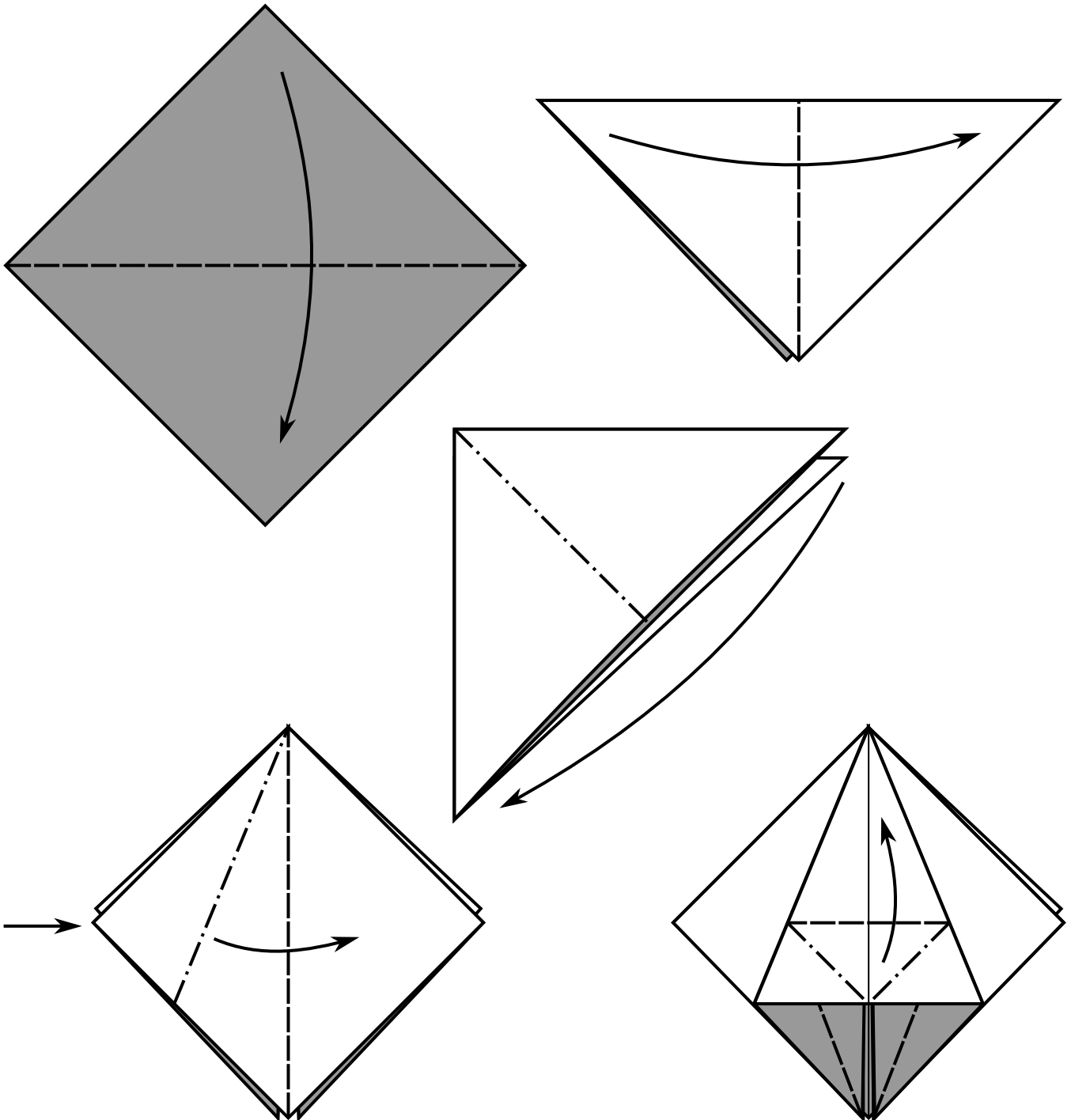



# The Bases of Folding

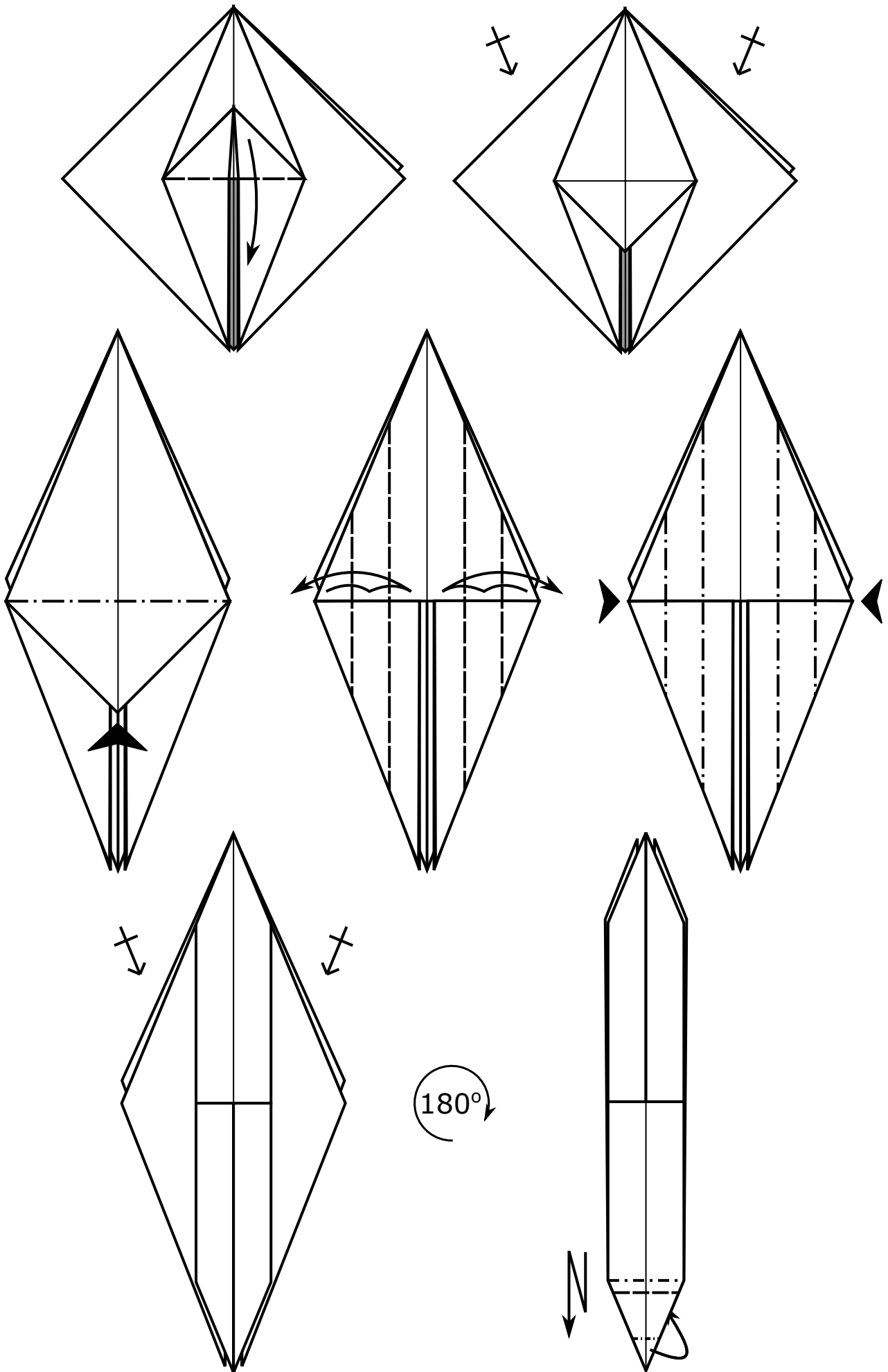

# The Bases of Folding

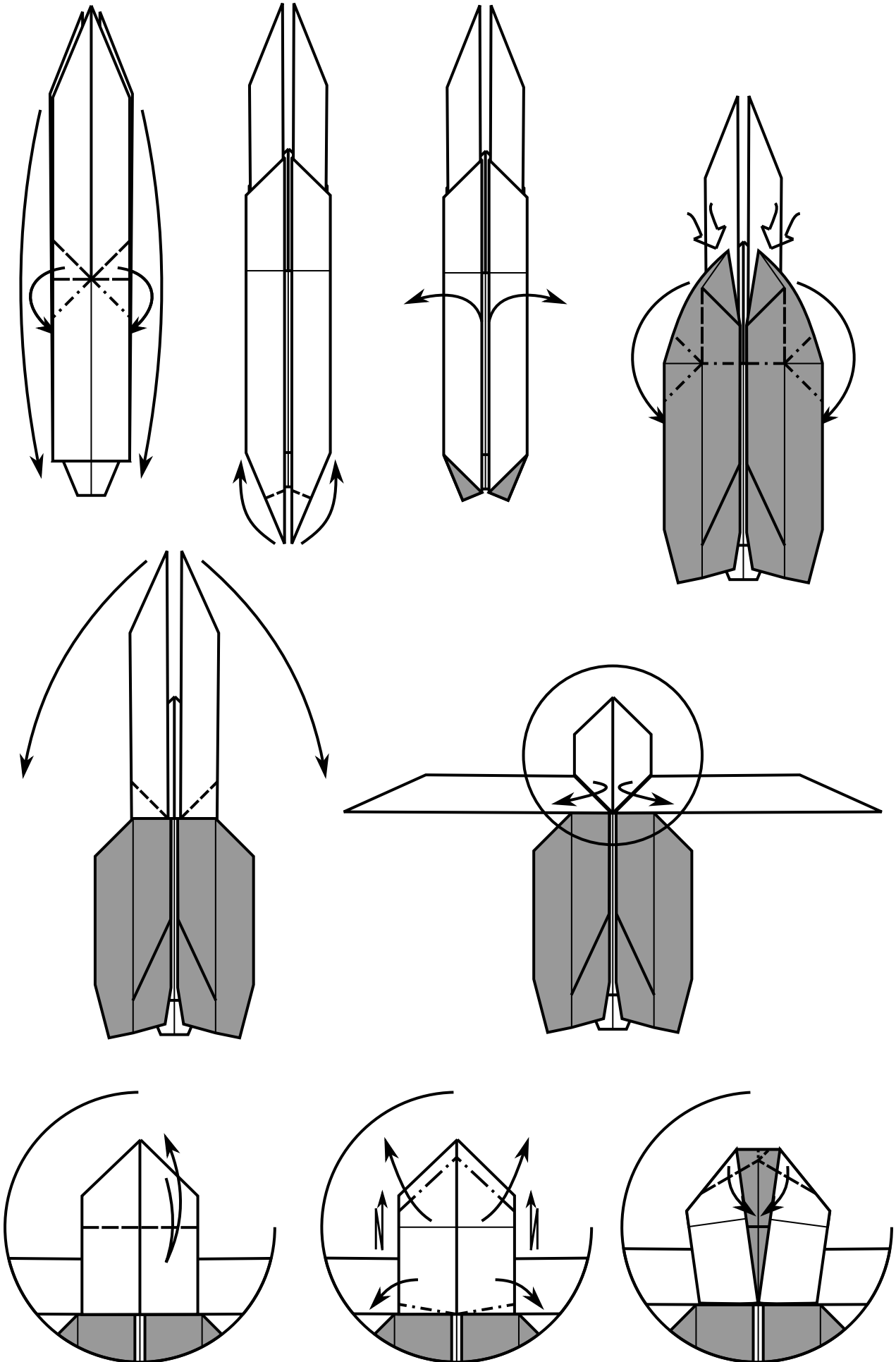

The Bases of Folding

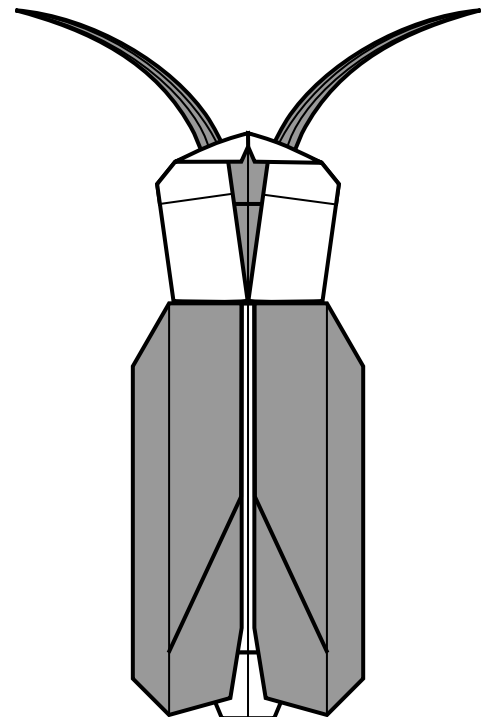
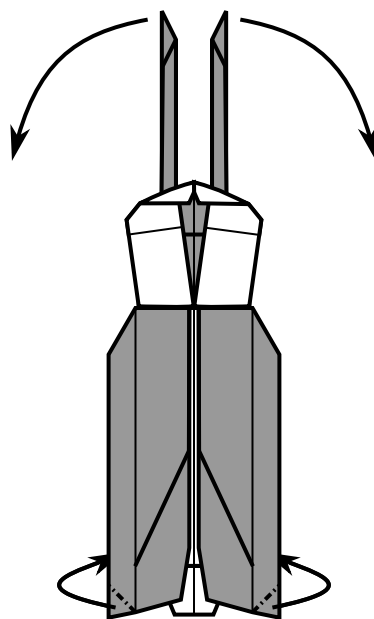
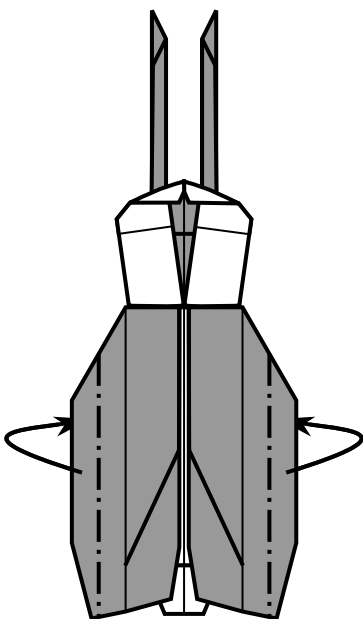
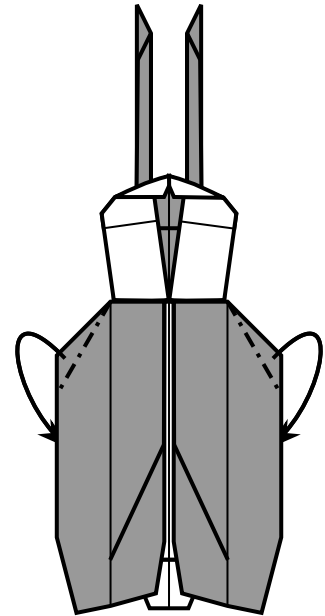
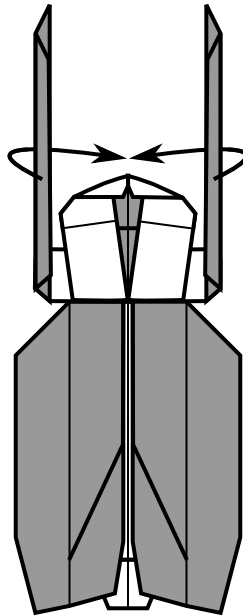
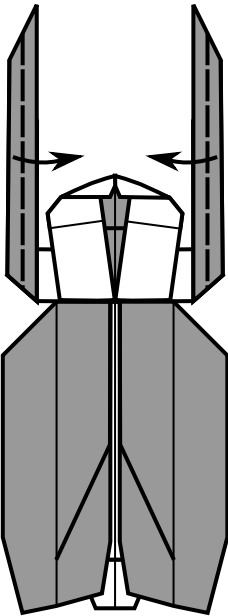
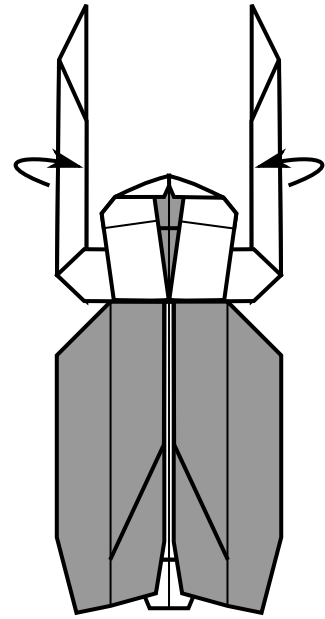
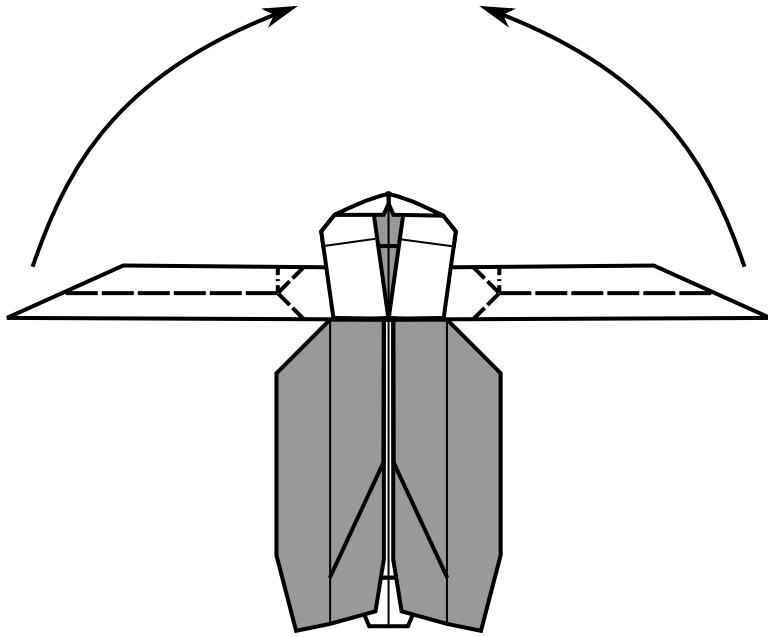

# Brittle Star

Occam's Razor states "Entities should not be multiplied without necessity." The simpler an explanation, the more likely it is to be correct. And the easiest way of doing something is usually the best.

It is entirely possible to fold any model using a square. But when you need five sides, it's probably less of a hassle to just start with a pentagon.

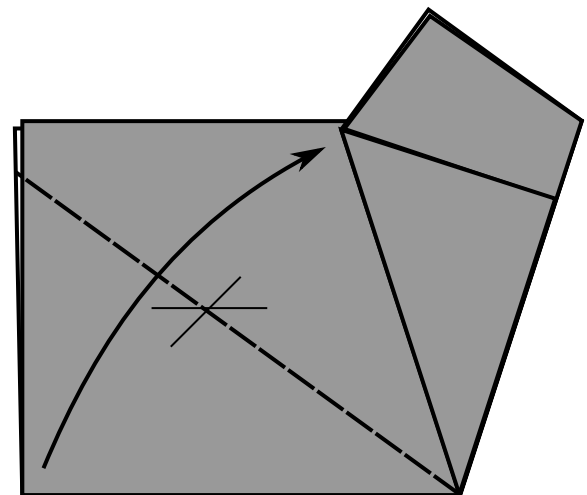
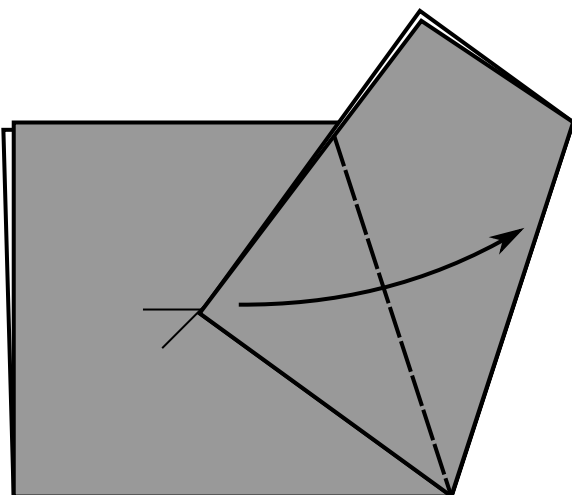
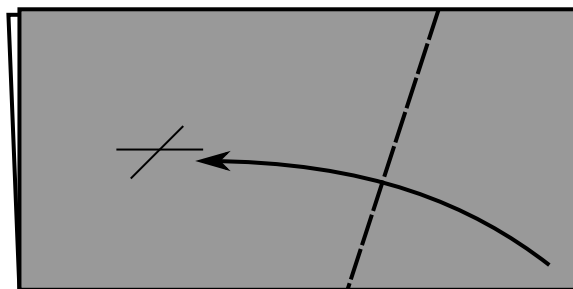
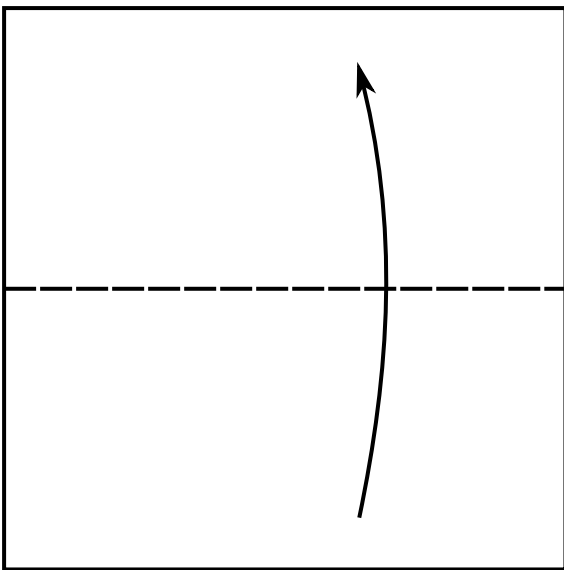

# The Bases of Folding

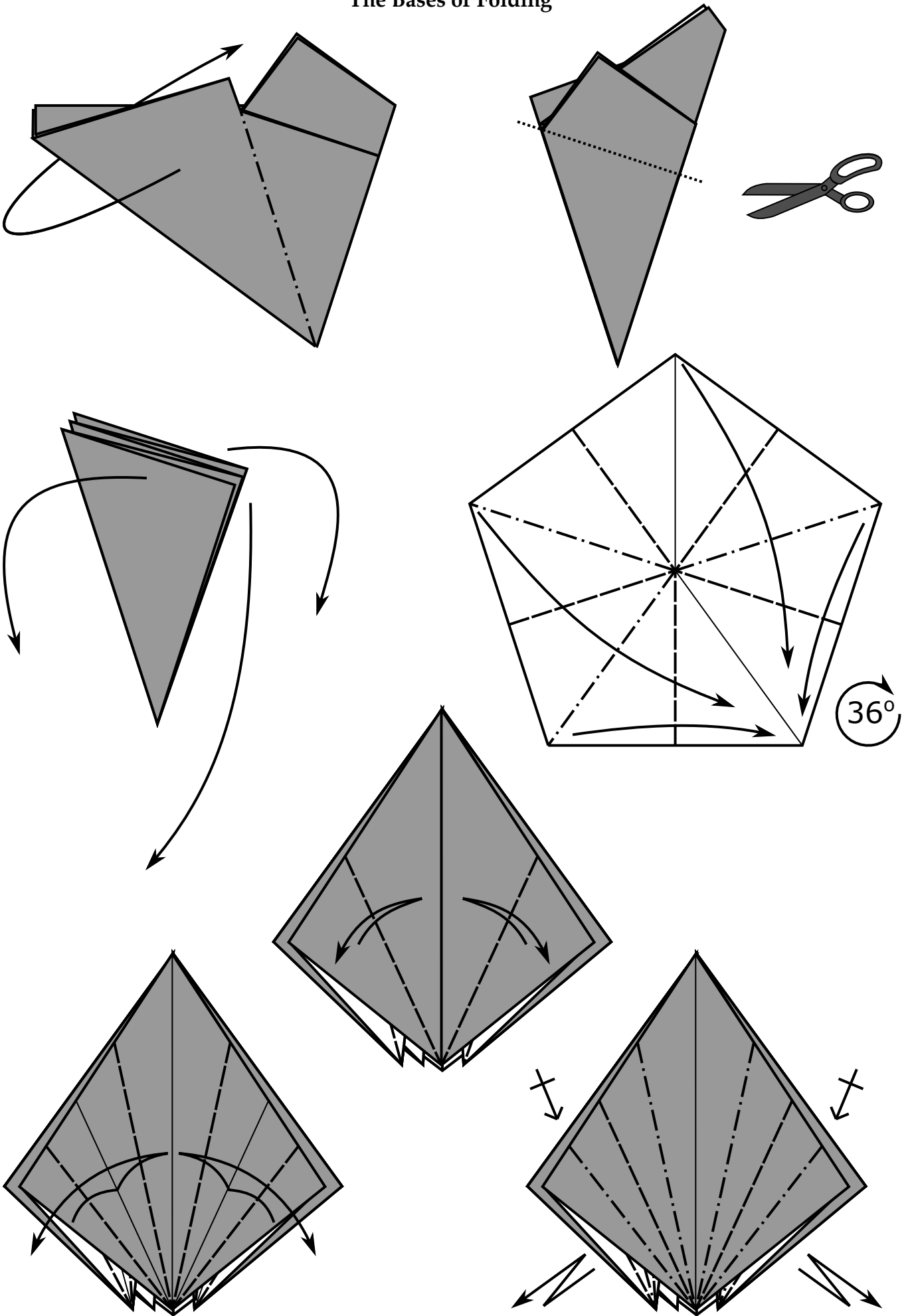

The Bases of Folding

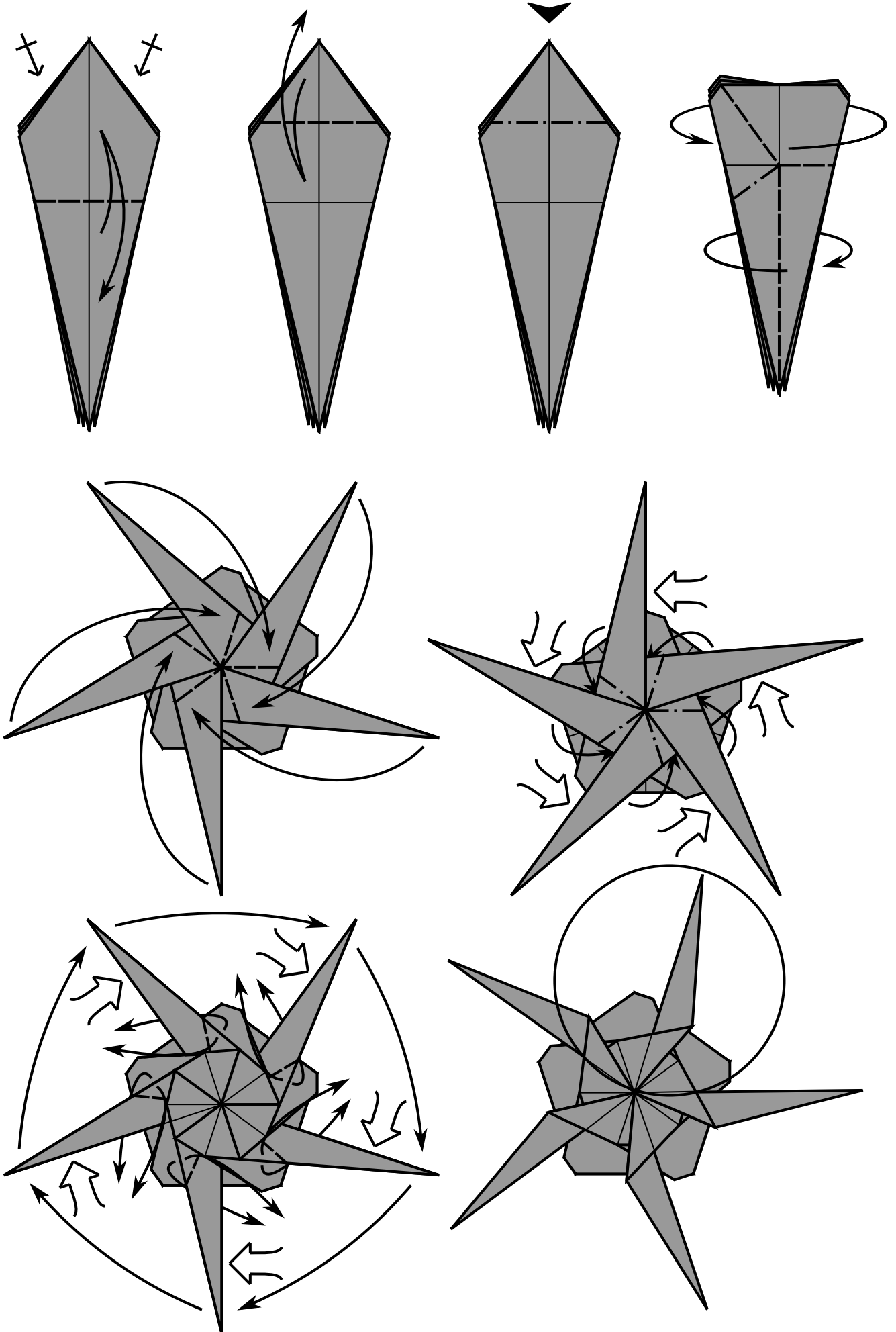

# The Bases of Folding

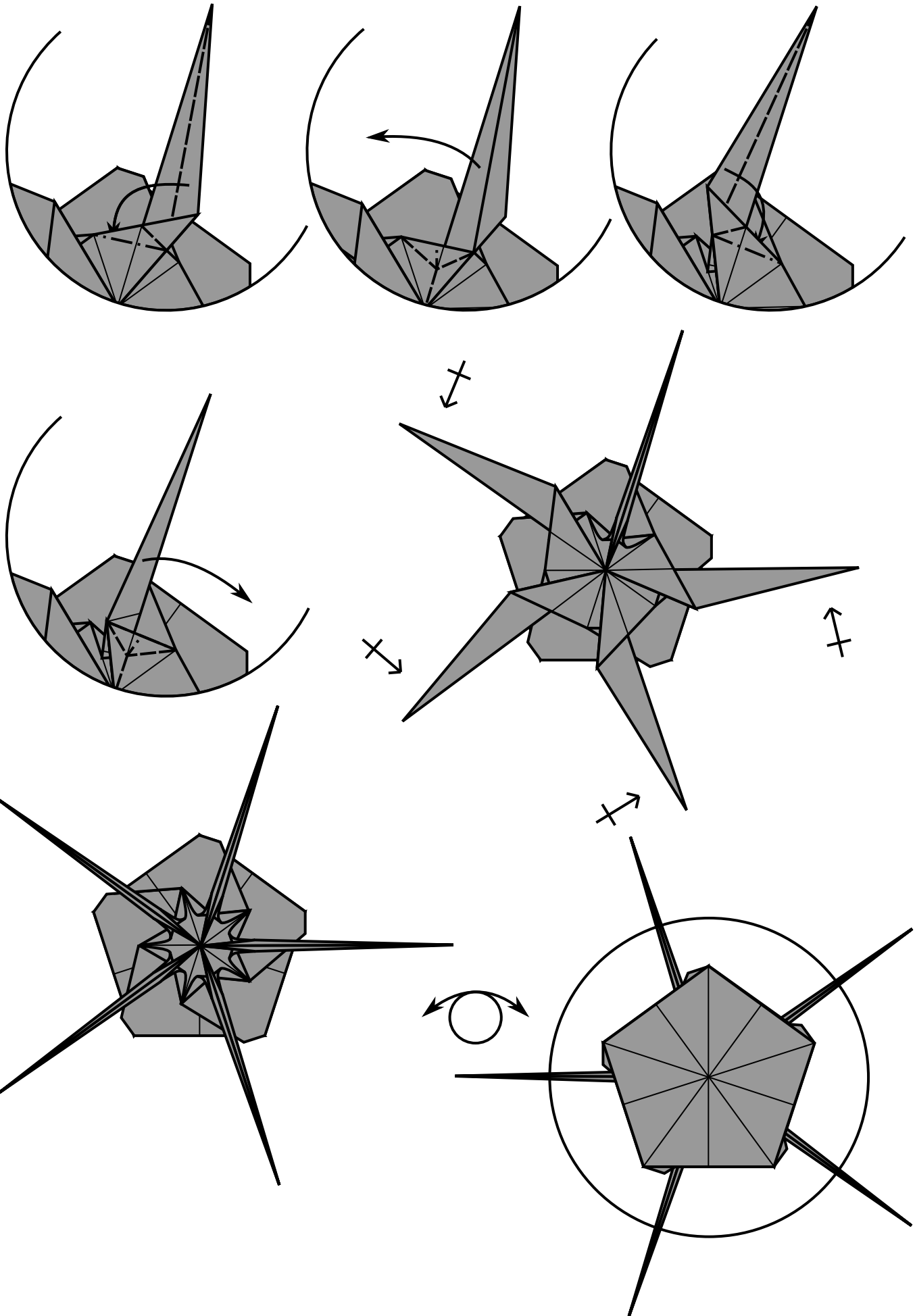

# The Bases of Folding

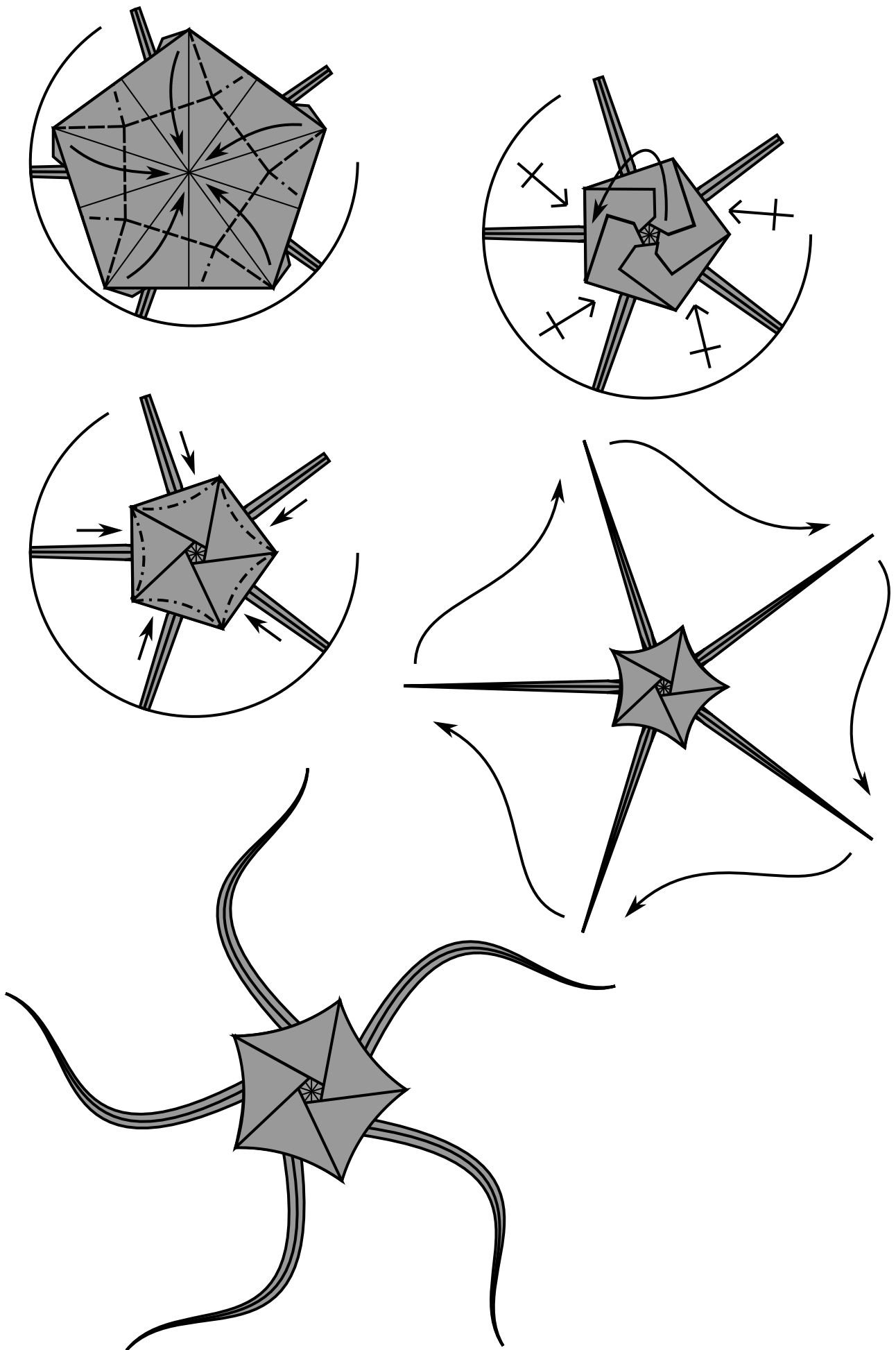



# Clam

Arithmetic beauty is rife in nature. Broccoli fractals, Fibonacci spiral shells, and multilateral symmetry exist all around us in everyday plants and animals, fascinating us with their uniformity.

The same symmetry can be applied to daily life. When you find yourself overindulging, remember what you need to accomplish, and when you've worked hard, remember to reward yourself. Try to find a balance that is natural for you.

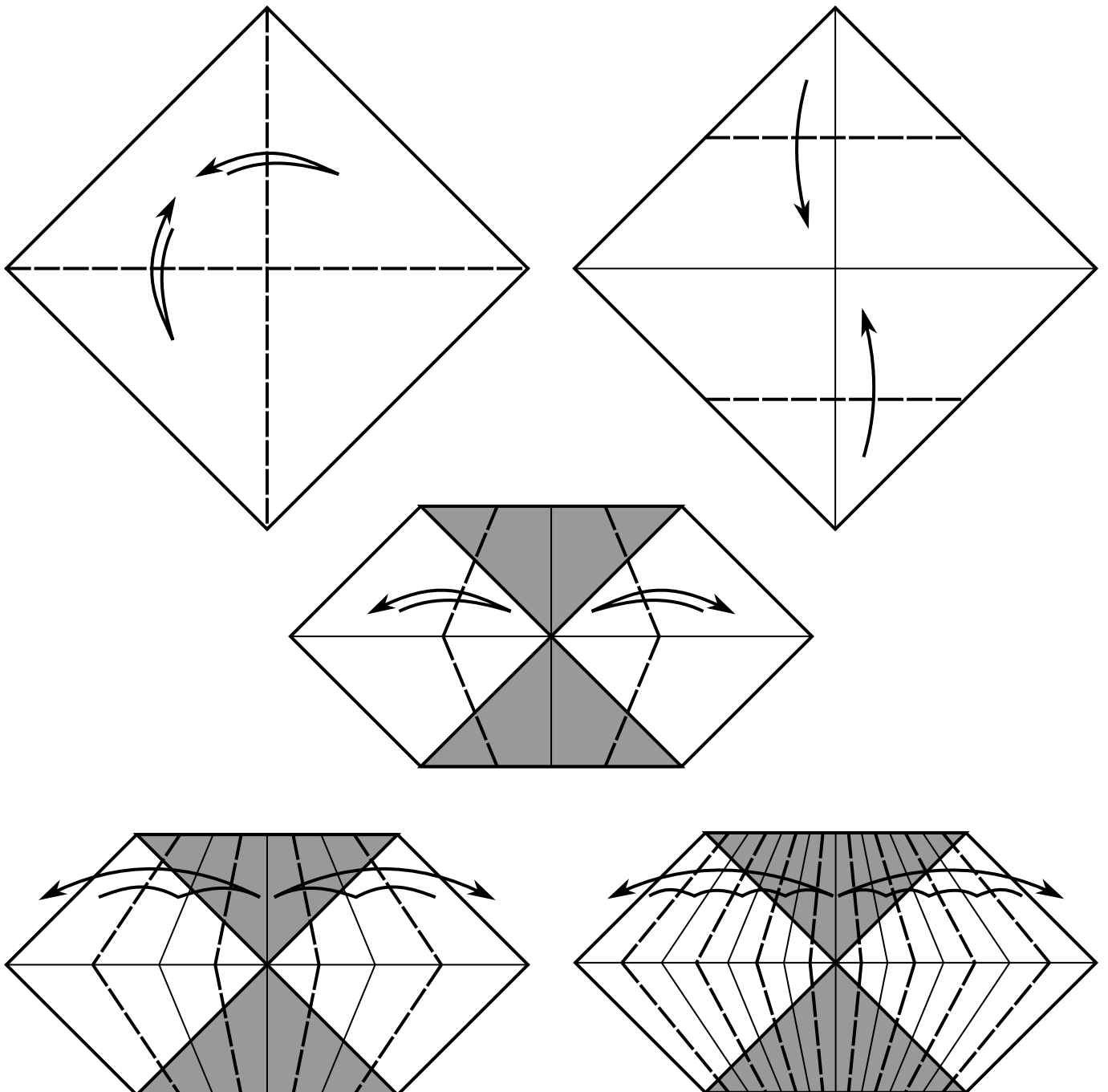

# The Bases of Folding

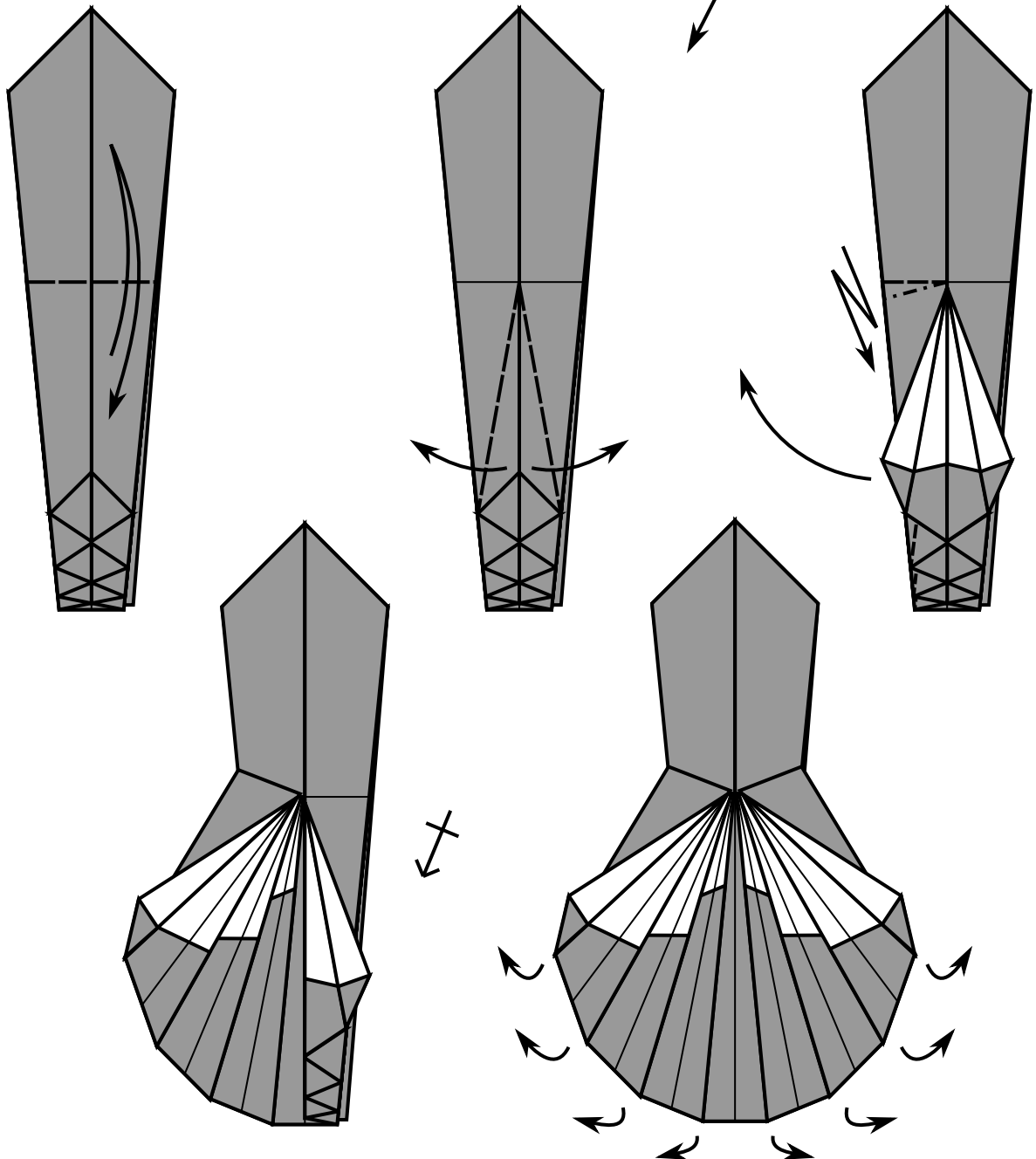
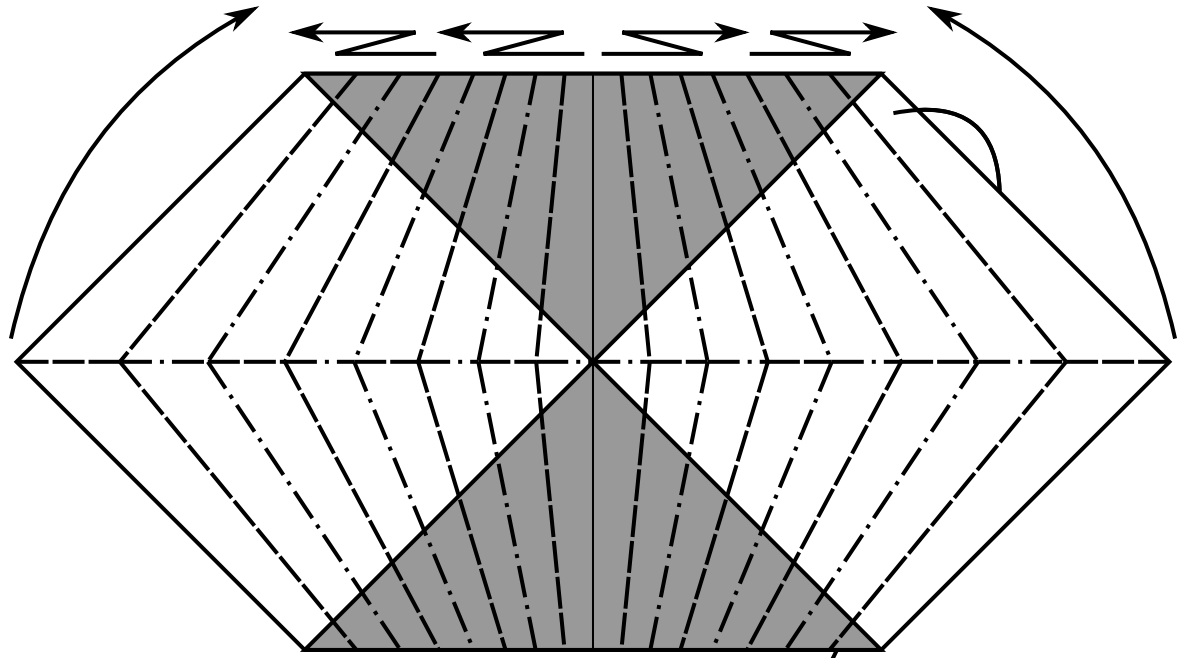

The Bases of Folding

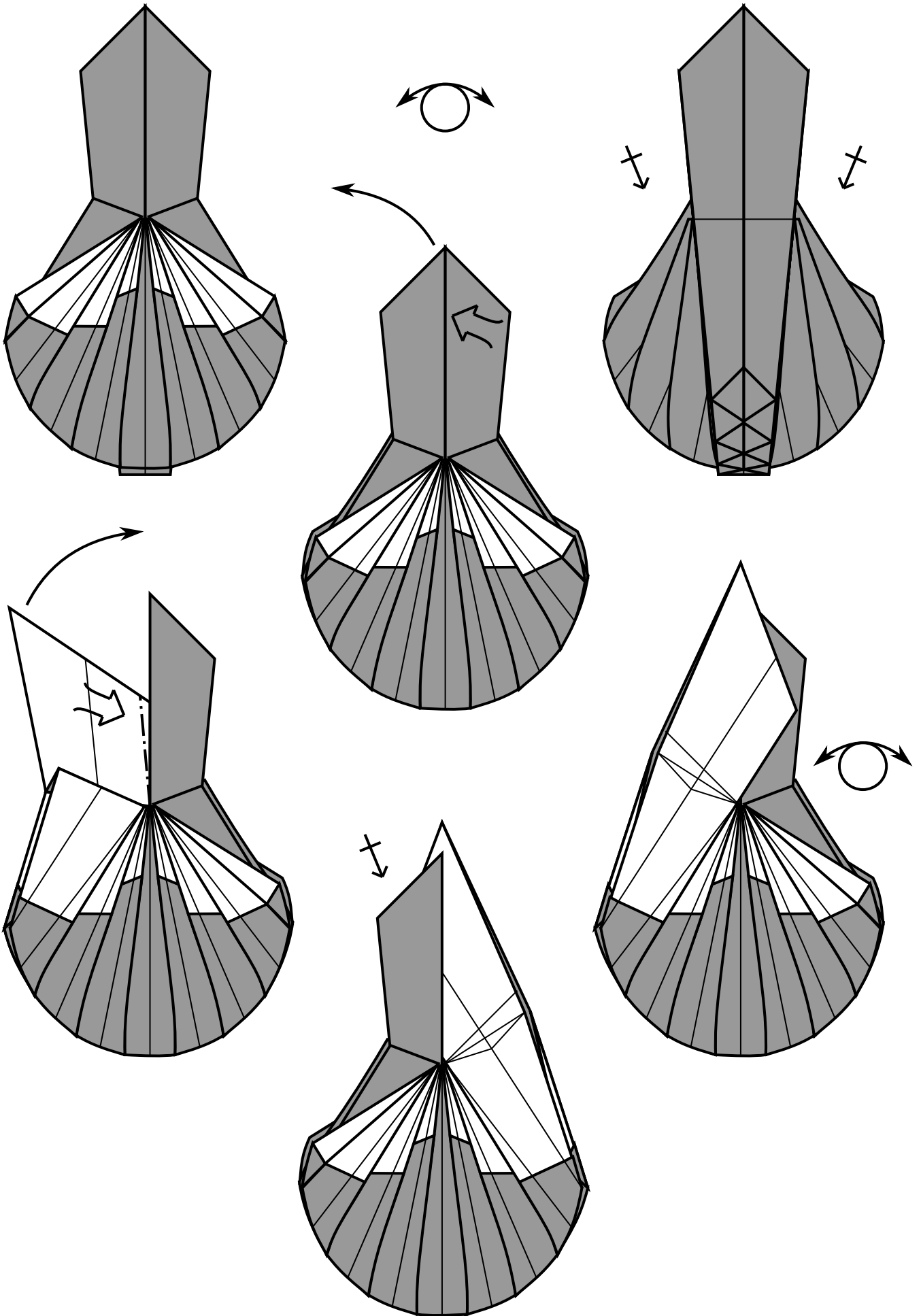

The Bases of Folding

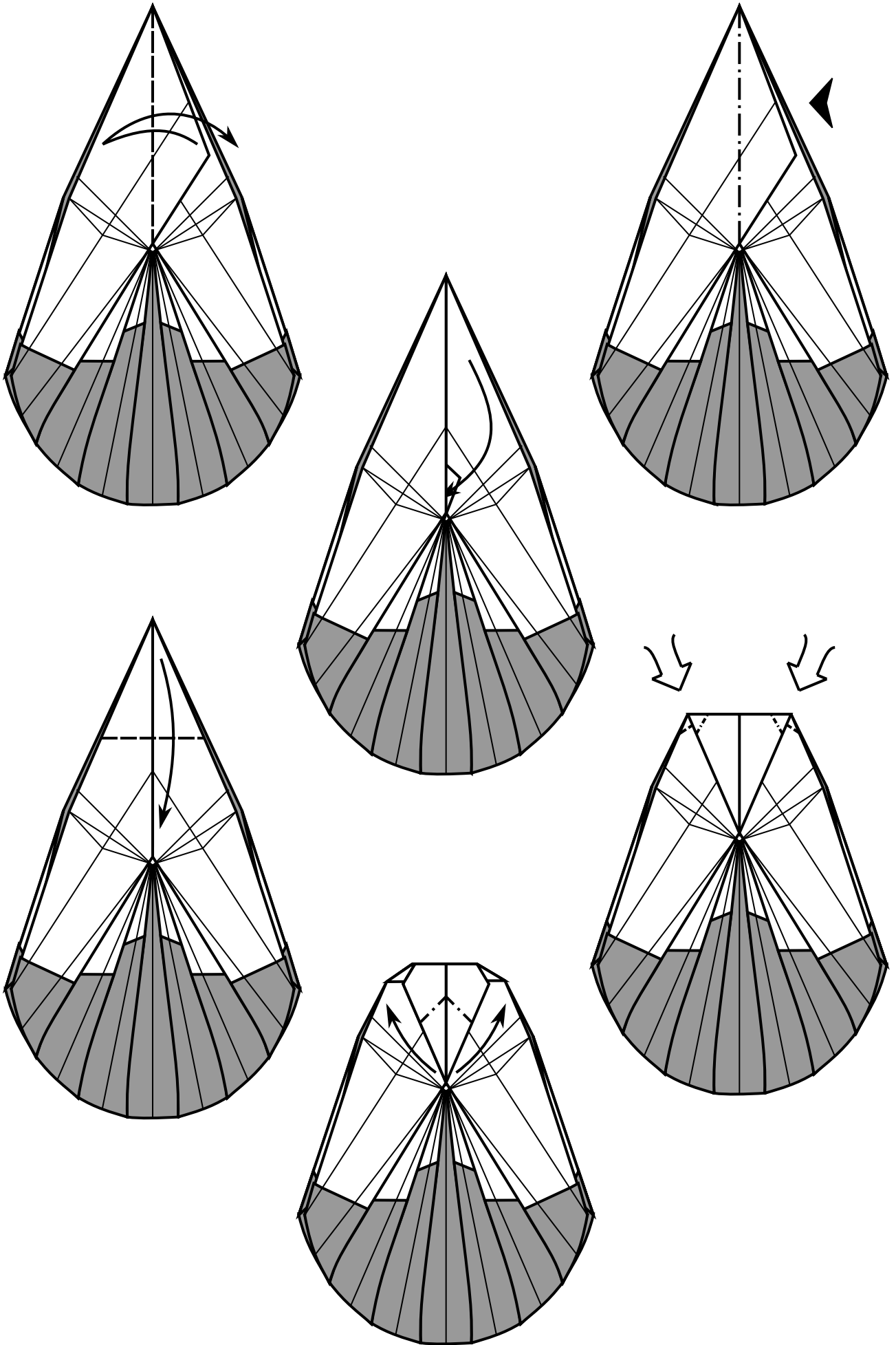

# The Bases of Folding

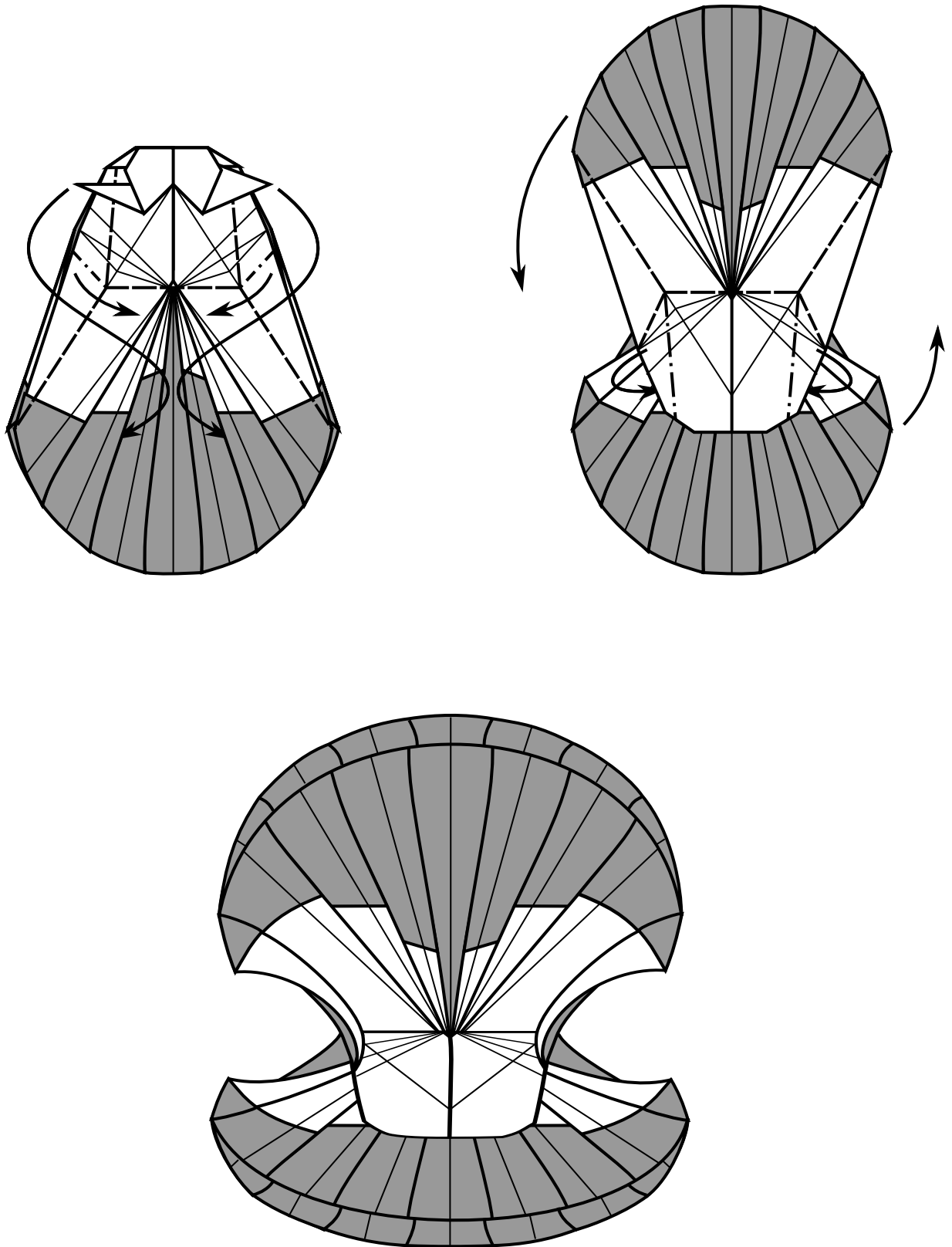

# Shrimp

Everything improves over time. Buildings get renovated to be up to code, medicine advances and cures new diseases, and the internet went from phone lines to WiFi.

When cutting paper became taboo in origami, a lot of the classic models got left behind. I decided to update one of them.

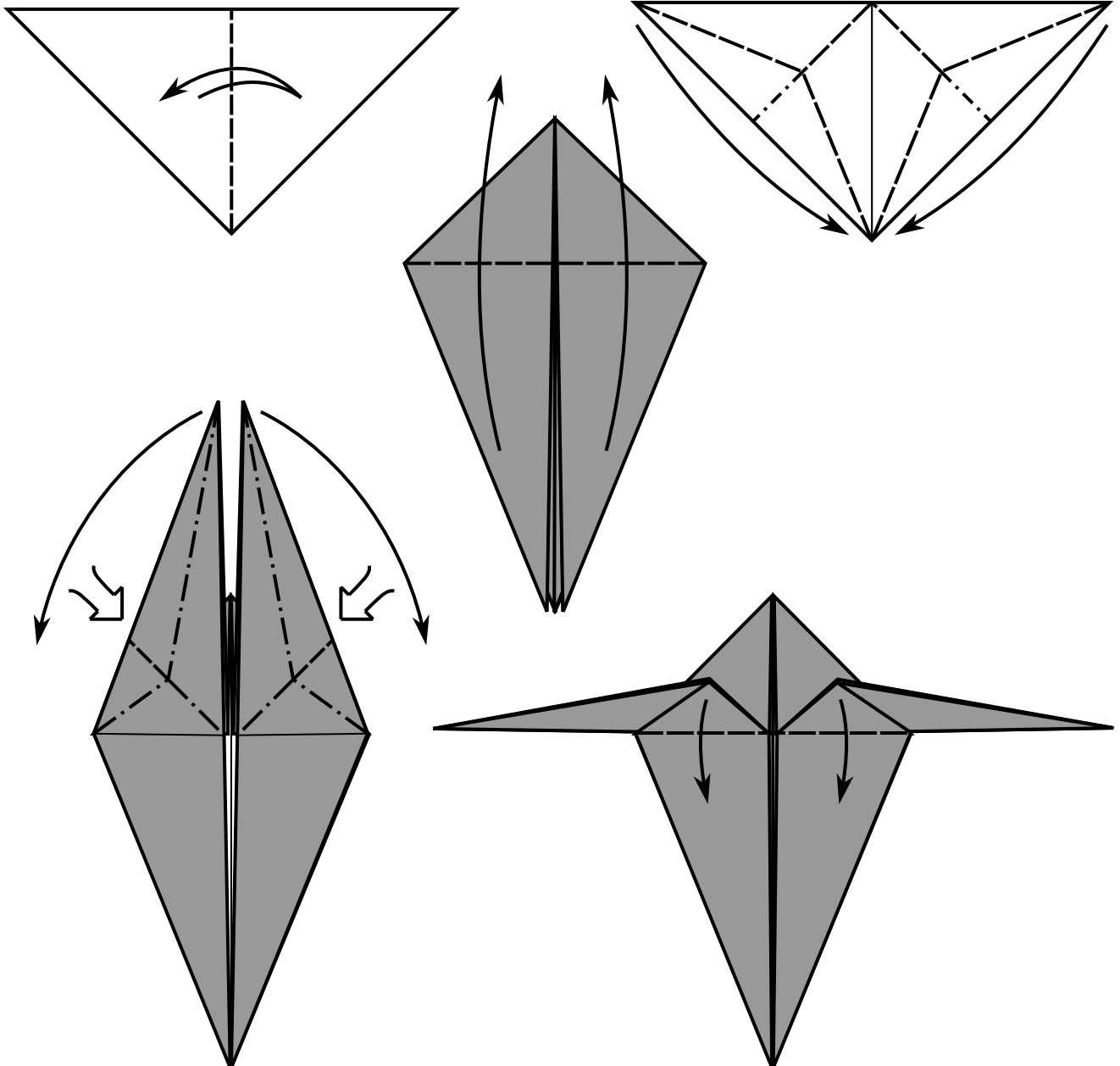
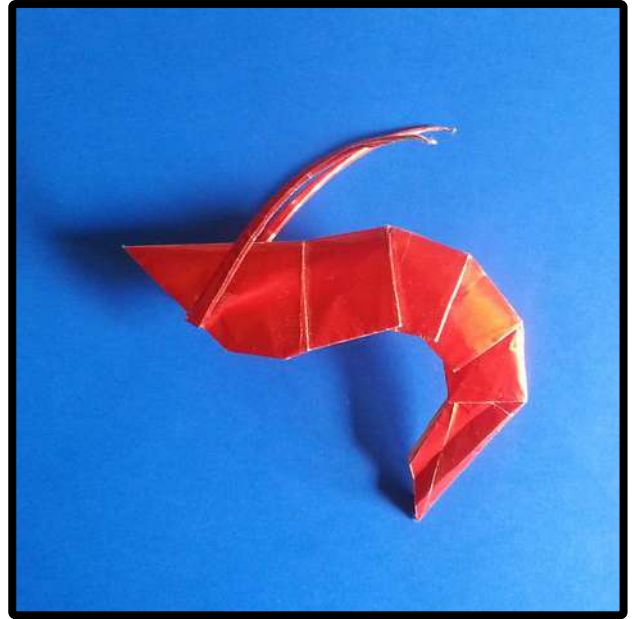

# The Bases of Folding

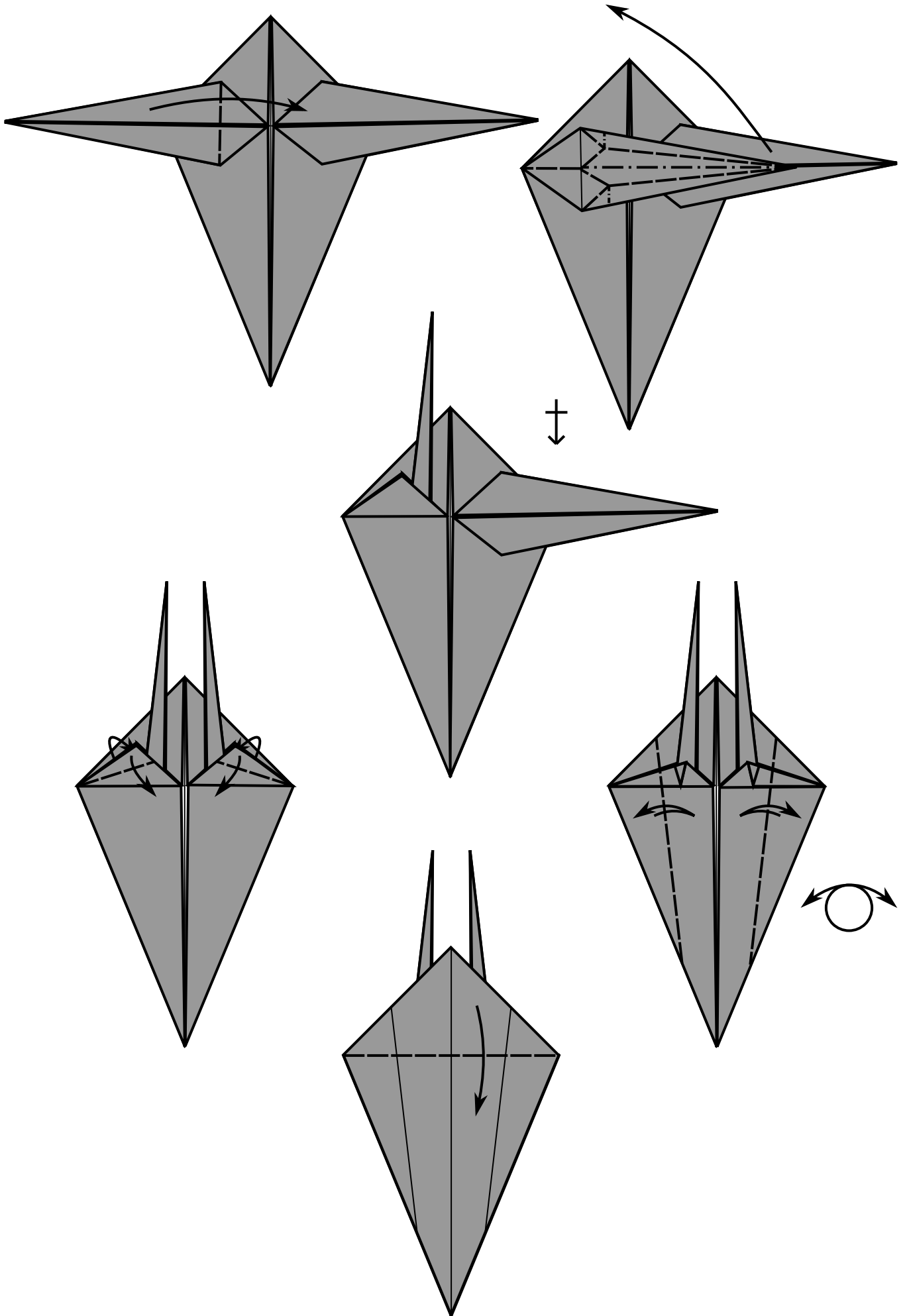

# The Bases of Folding

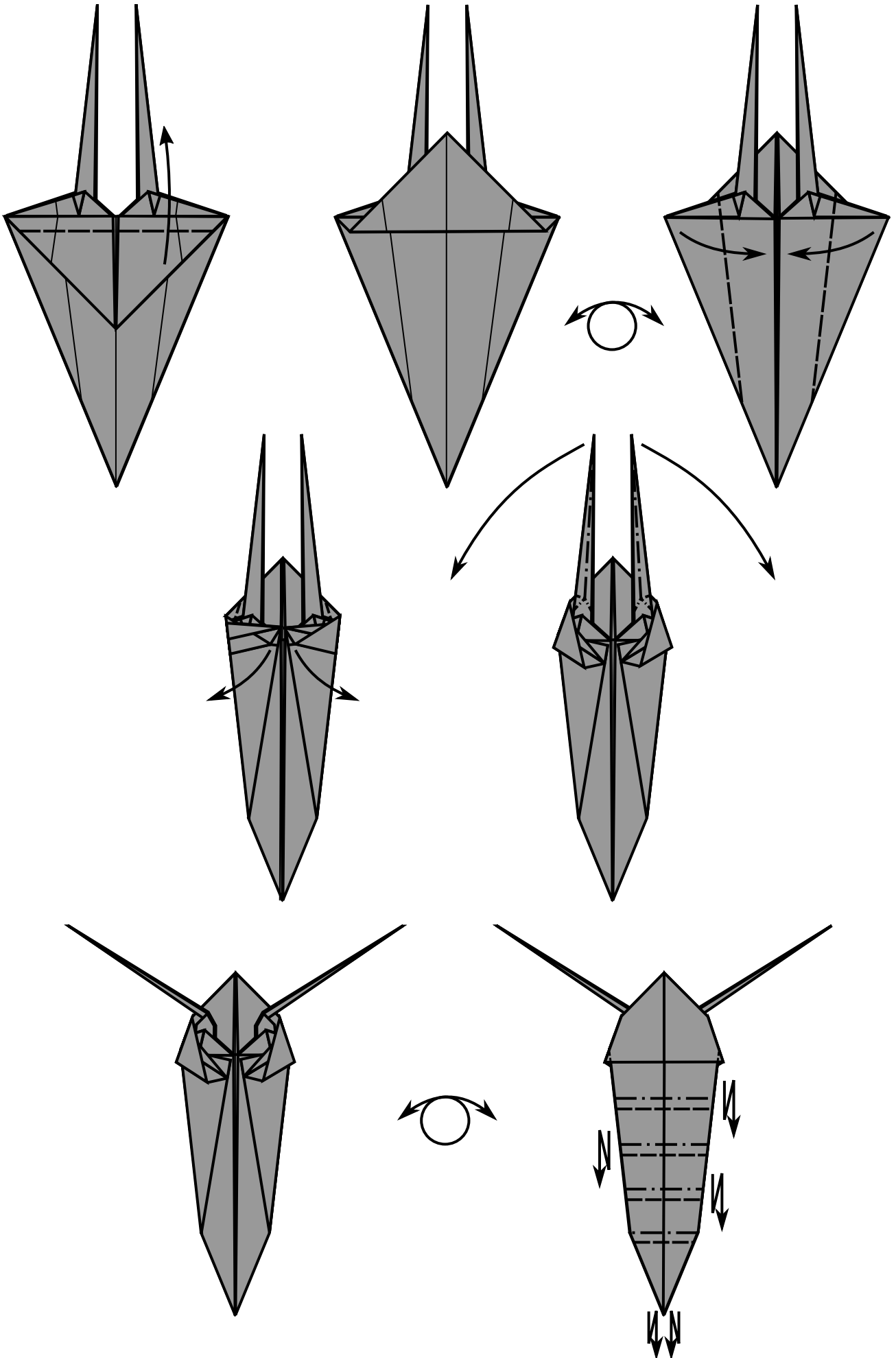



# The Bases of Folding

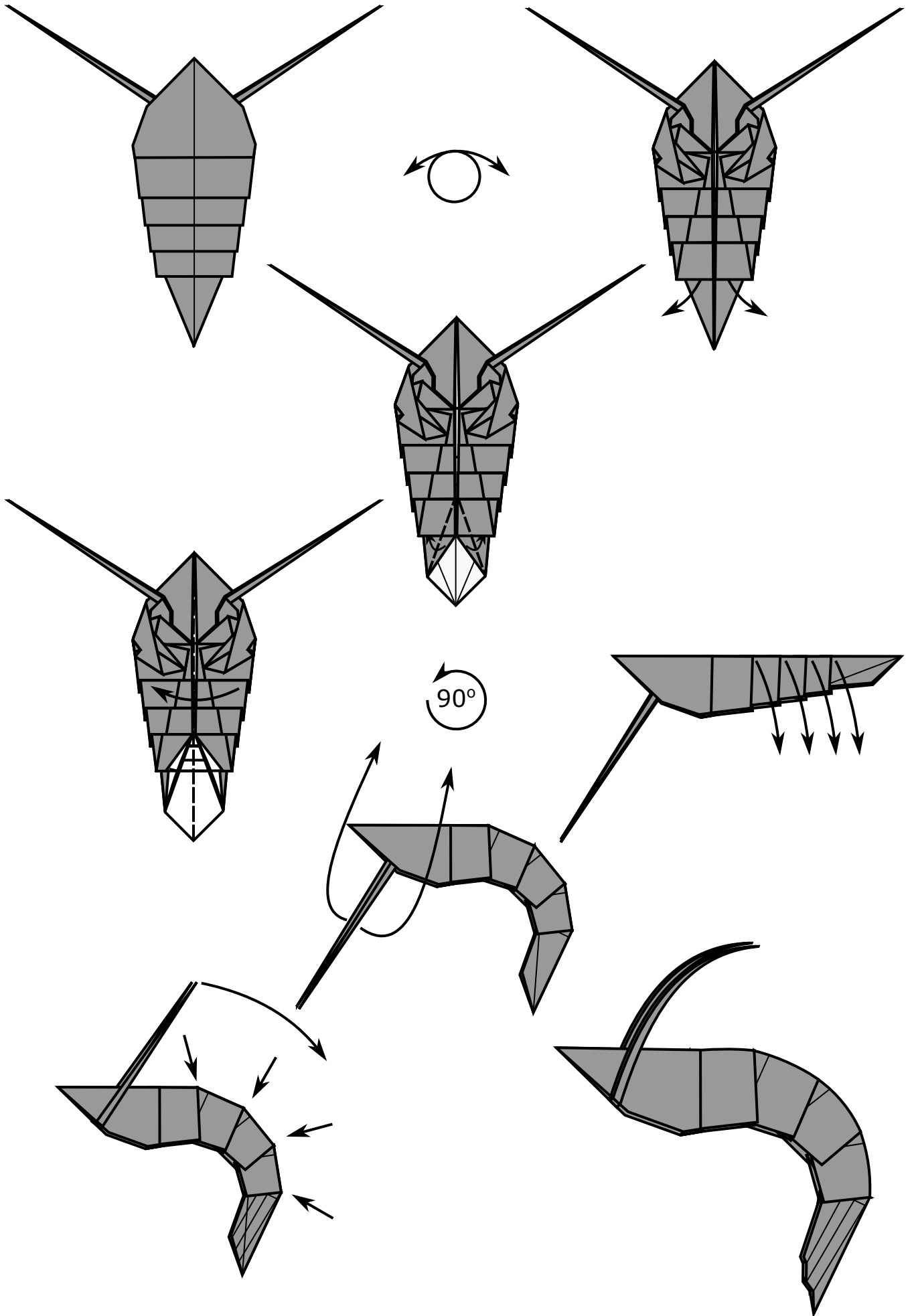

# Goldfish

It's been said that every great song has already been written, and classic films are getting the remake treatment everyday. Also, I made this updated model only to find that Lang and Montroll had beaten me to it years before.

But this all speaks to a greater point. Art is the shared experience of humanity, and reoccurring themes illustrate that we have found beauty and meaning in similar ways for thousands of years.

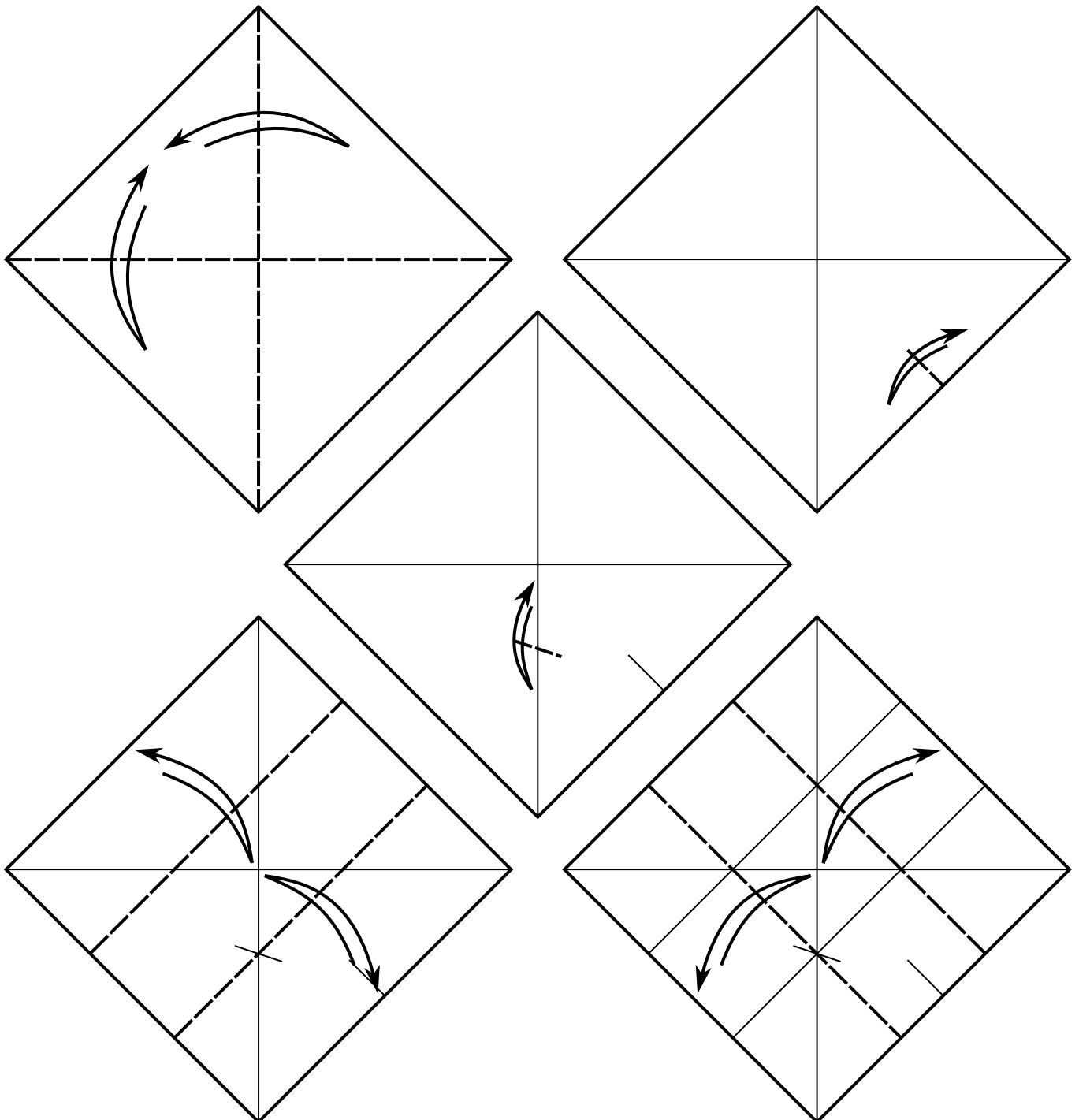

# The Bases of Folding

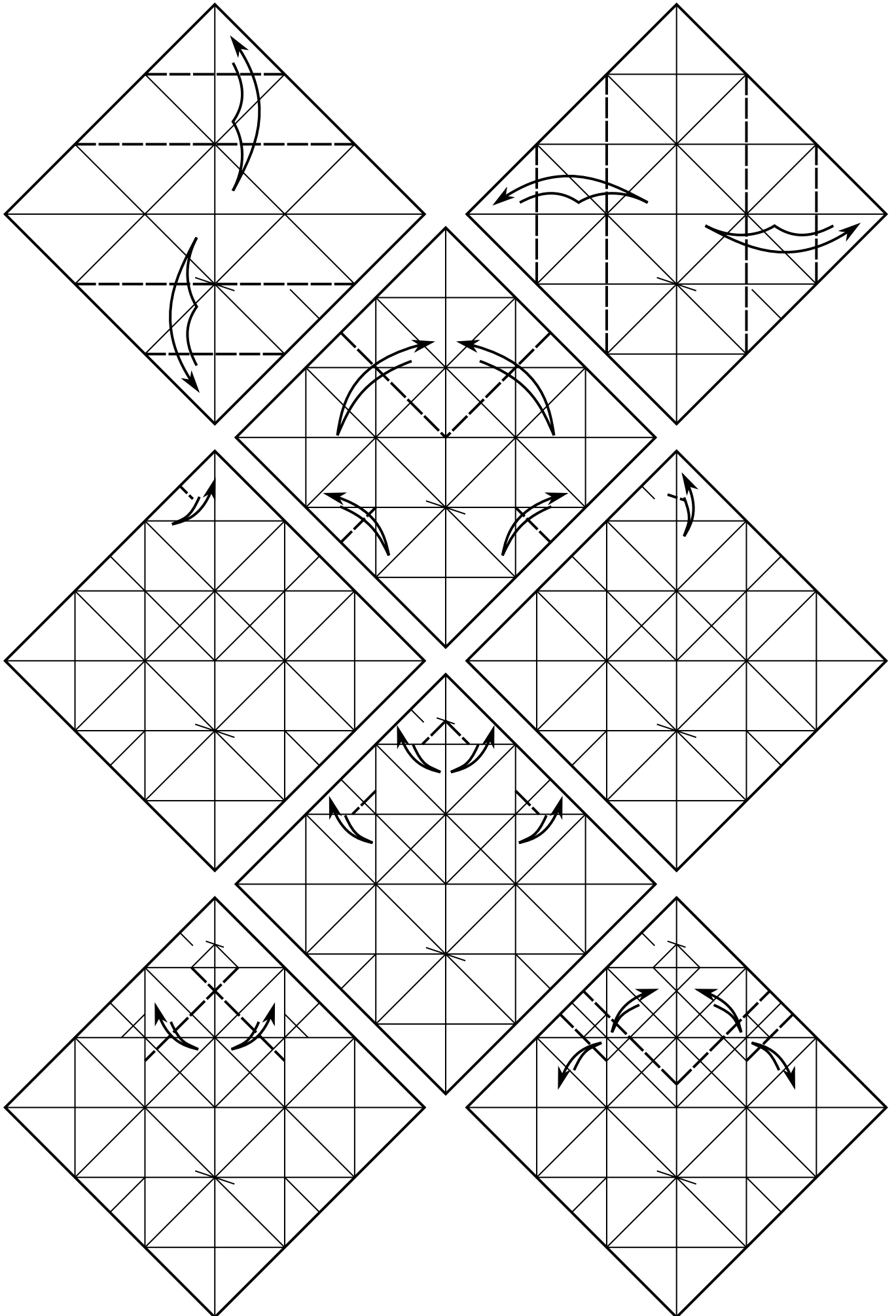

# The Bases of Folding

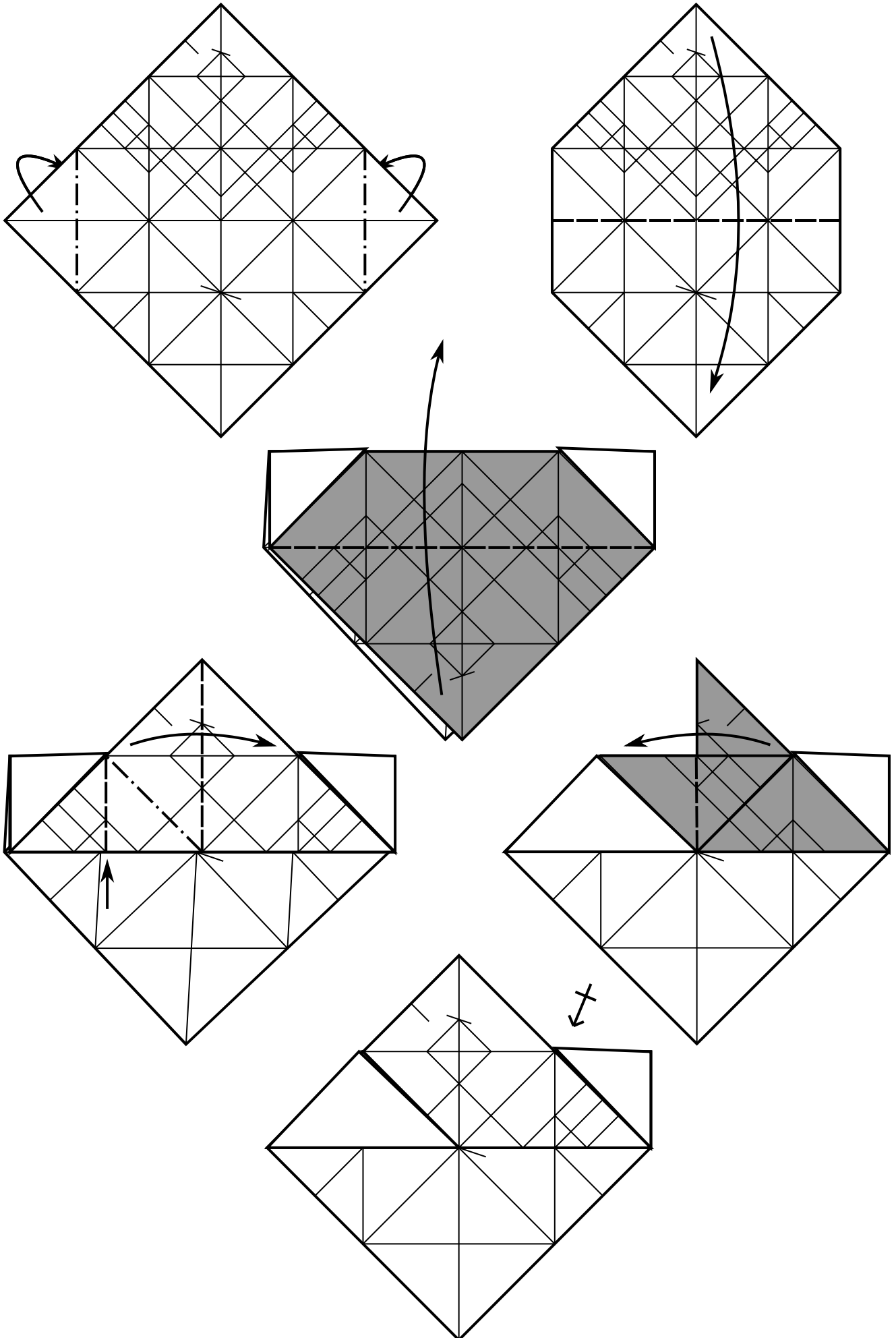

# The Bases of Folding

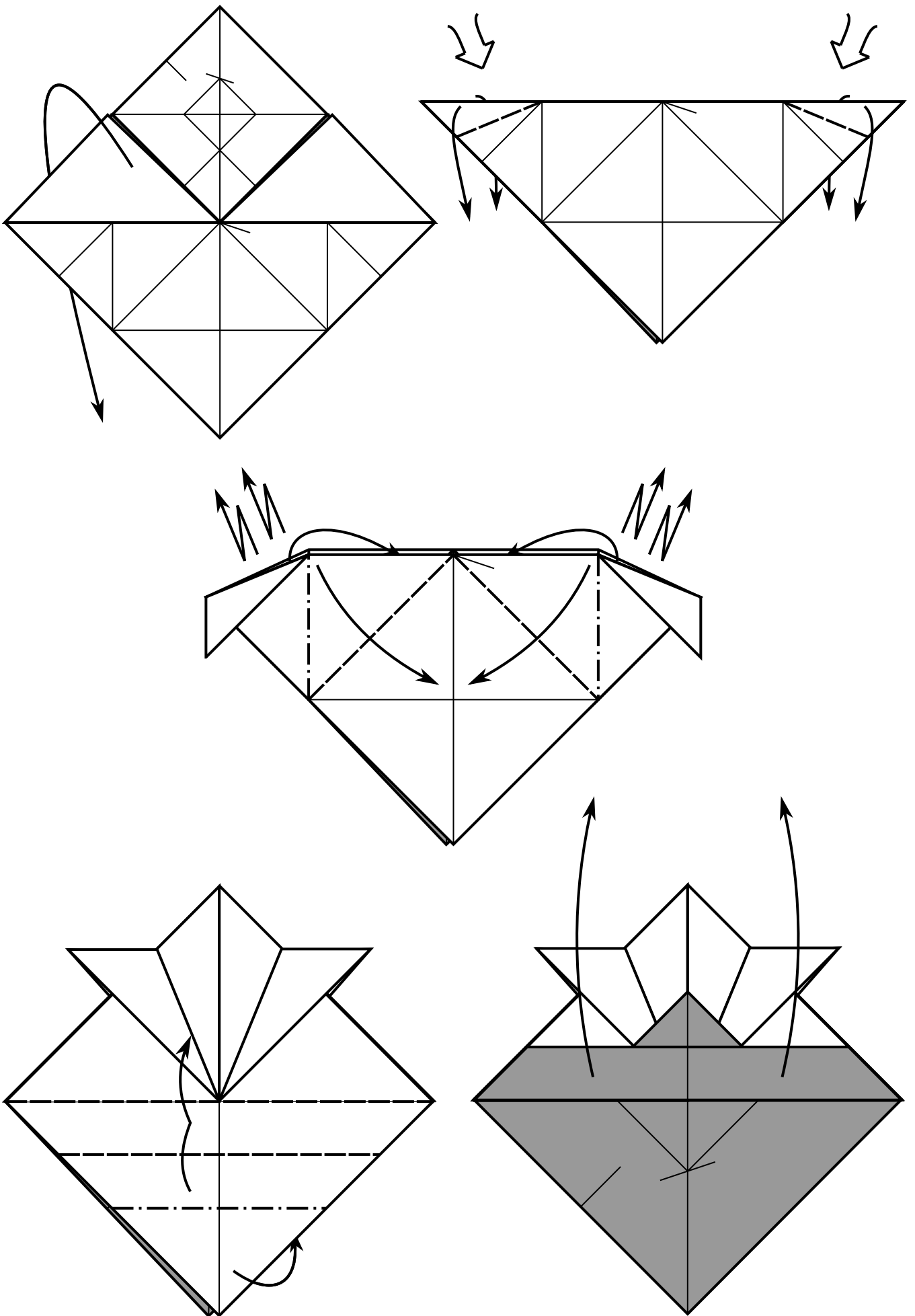

# The Bases of Folding

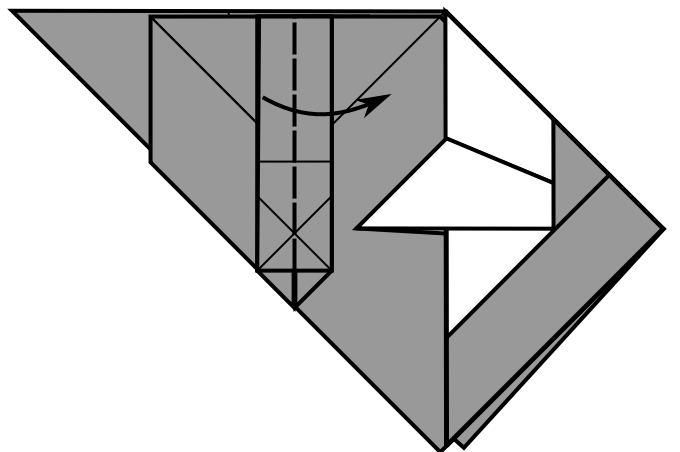
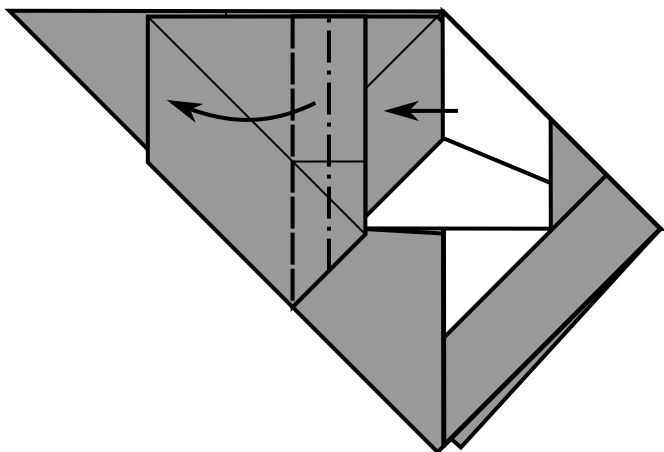
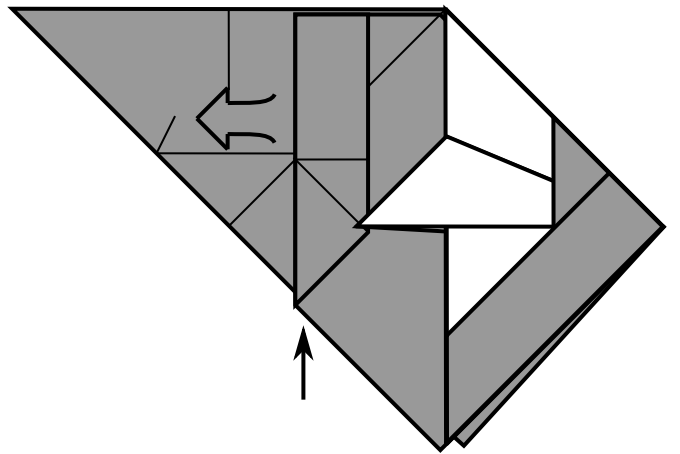
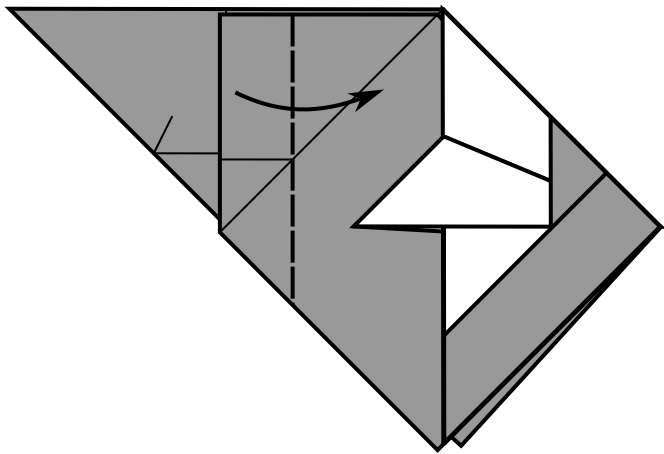
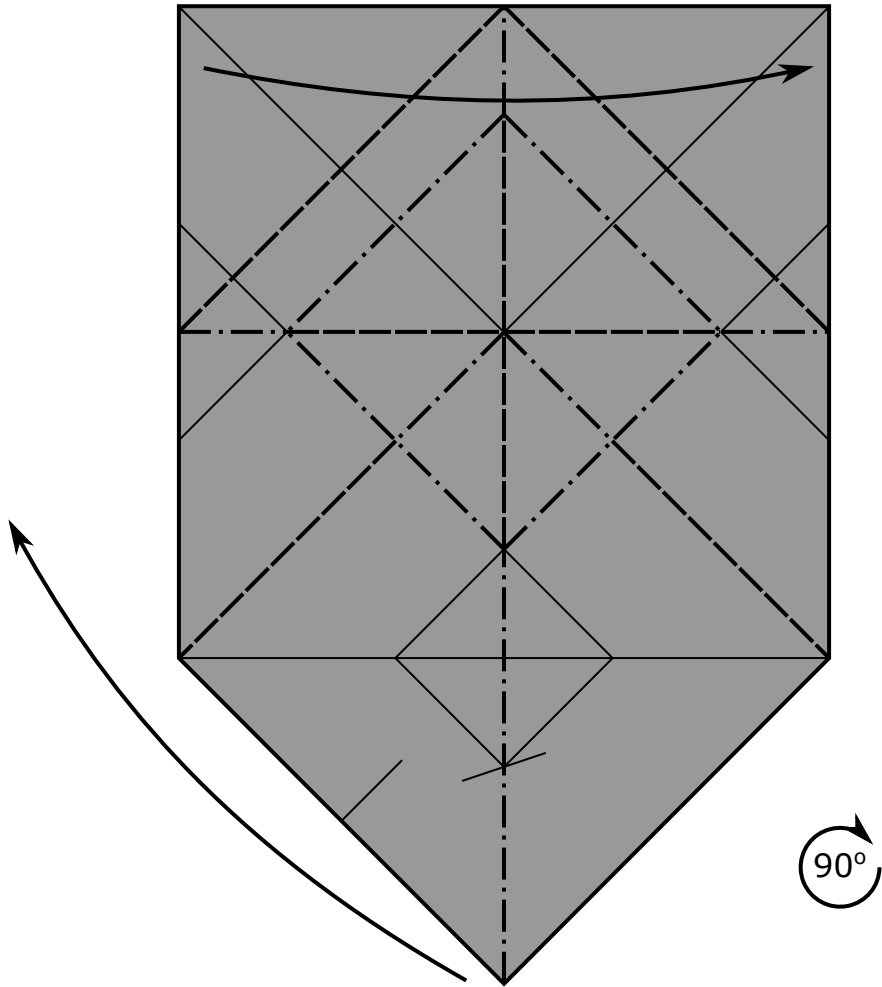

# The Bases of Folding

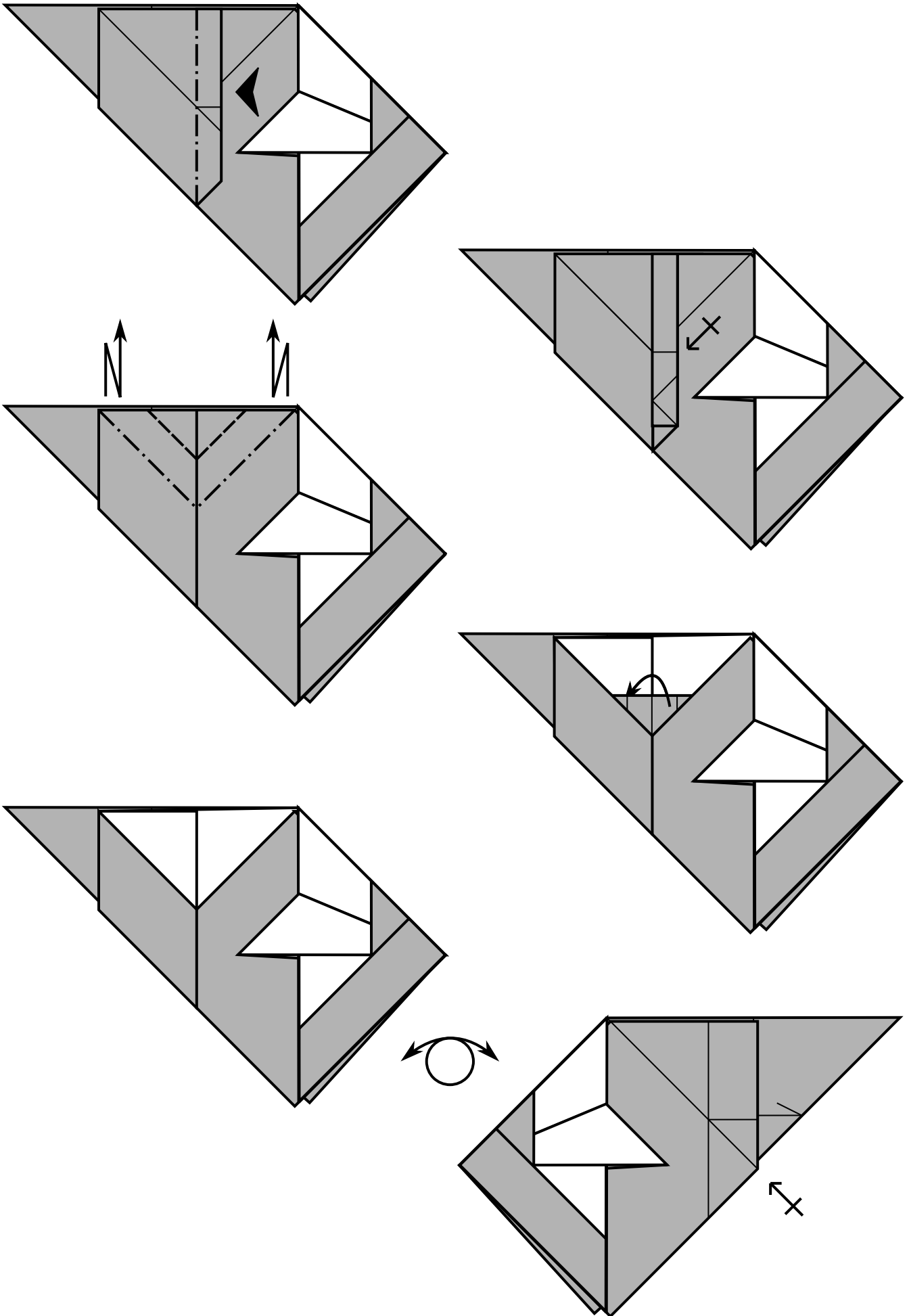

# The Bases of Folding

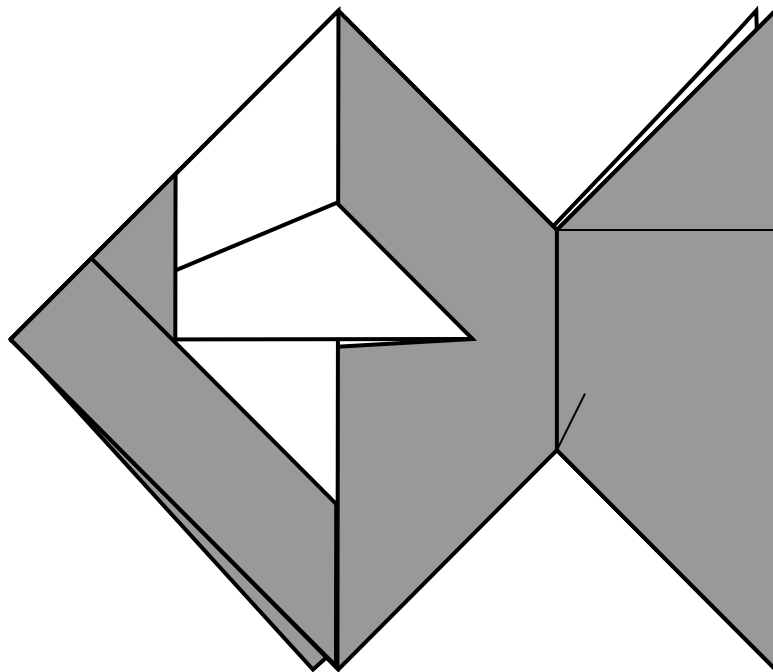
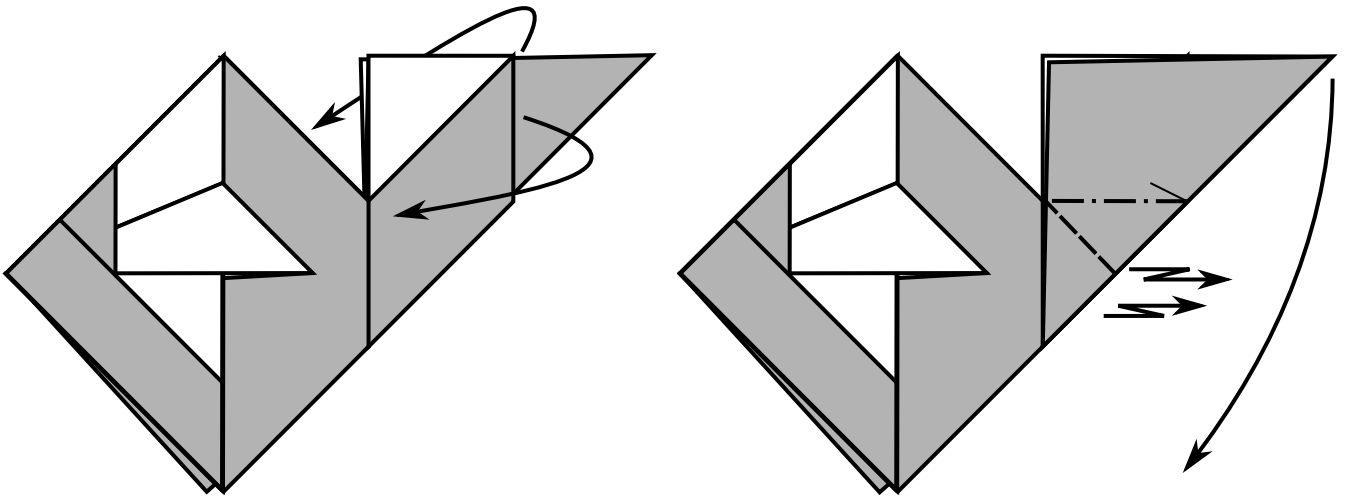



# Bat

As Ringo famously said, "I get by with a little help from my friends." The thing I've always loved about origami is that it's one big community, and people are always eager to lend a helping hand.

I created this model for Ondřej Cibulka, who was making a collaborative book. The first draft was not stellar, but Ondřej really improved upon the original idea, and now two books across the world have this shared design.

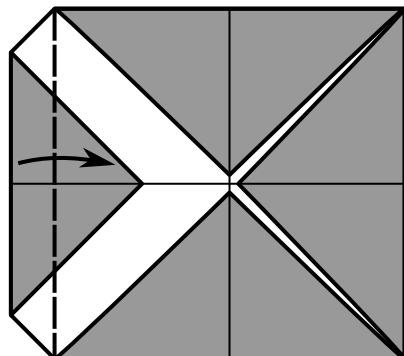
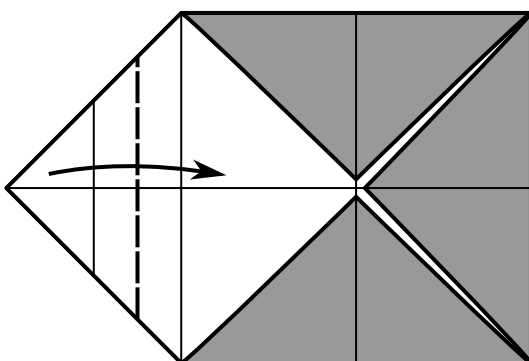
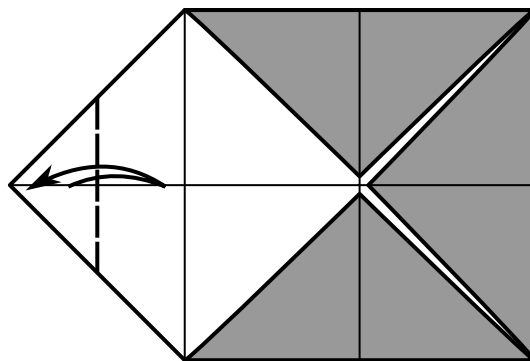
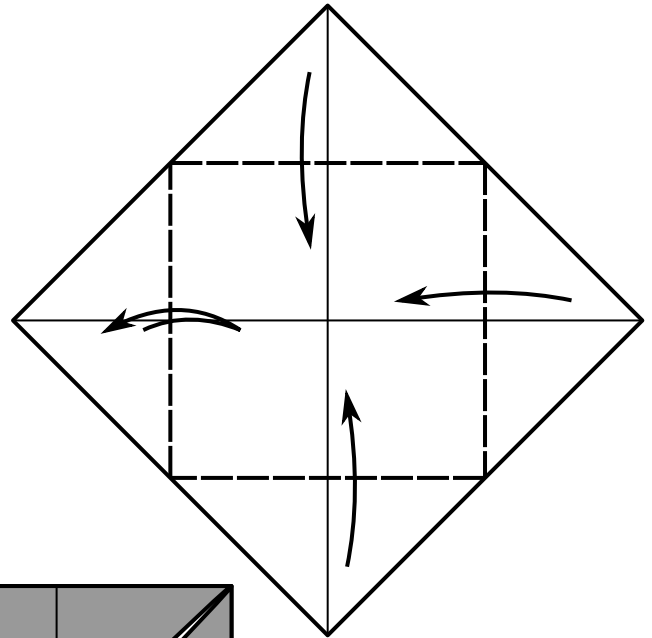
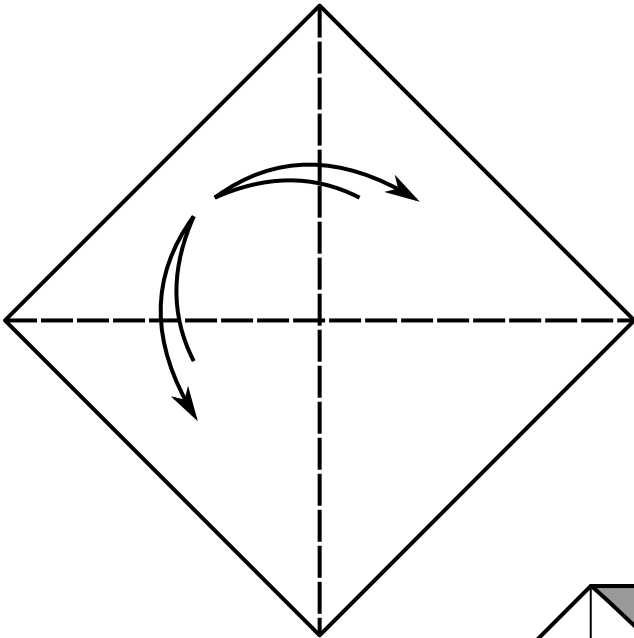

# The Bases of Folding

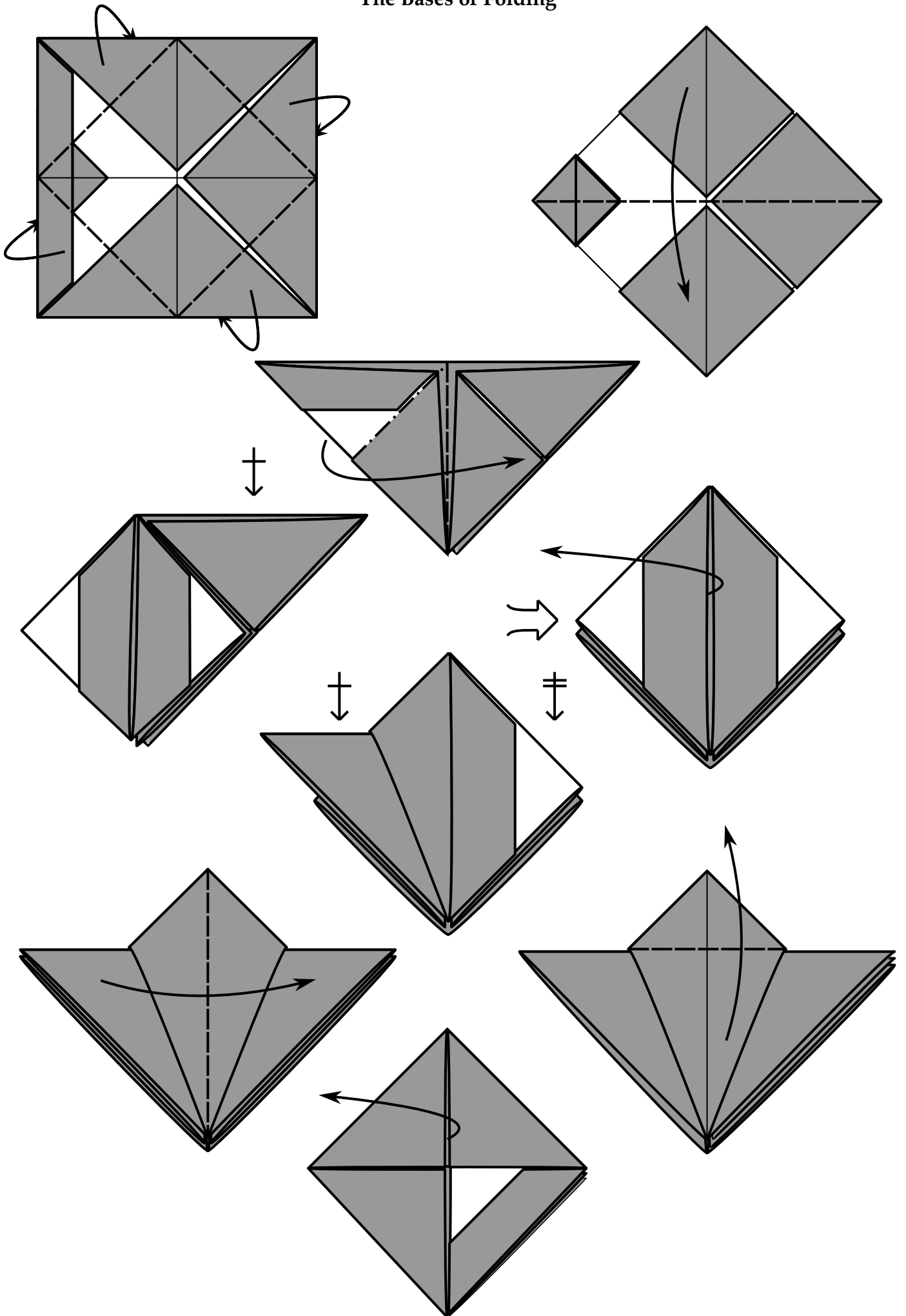

# The Bases of Folding

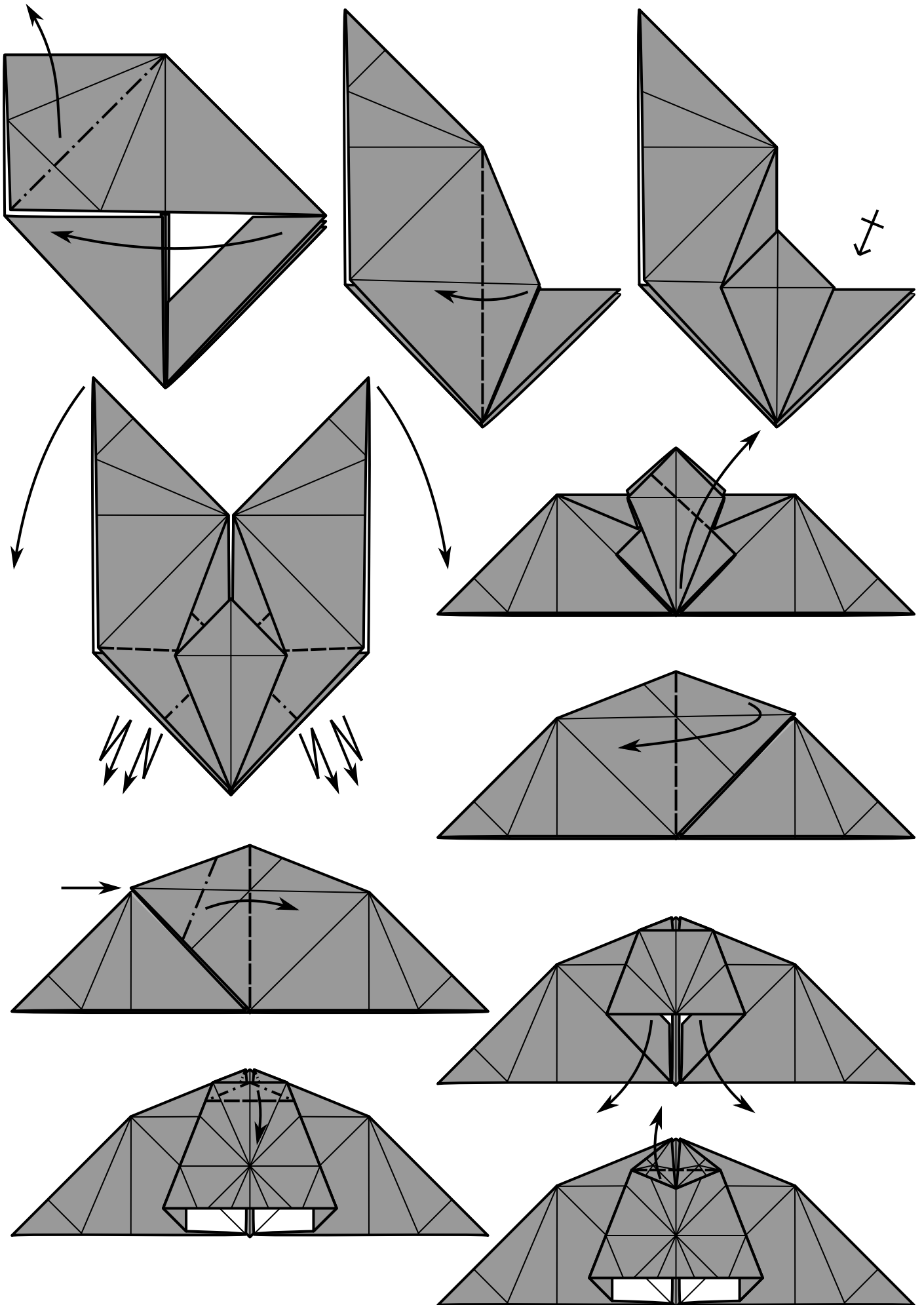

# The Bases of Folding

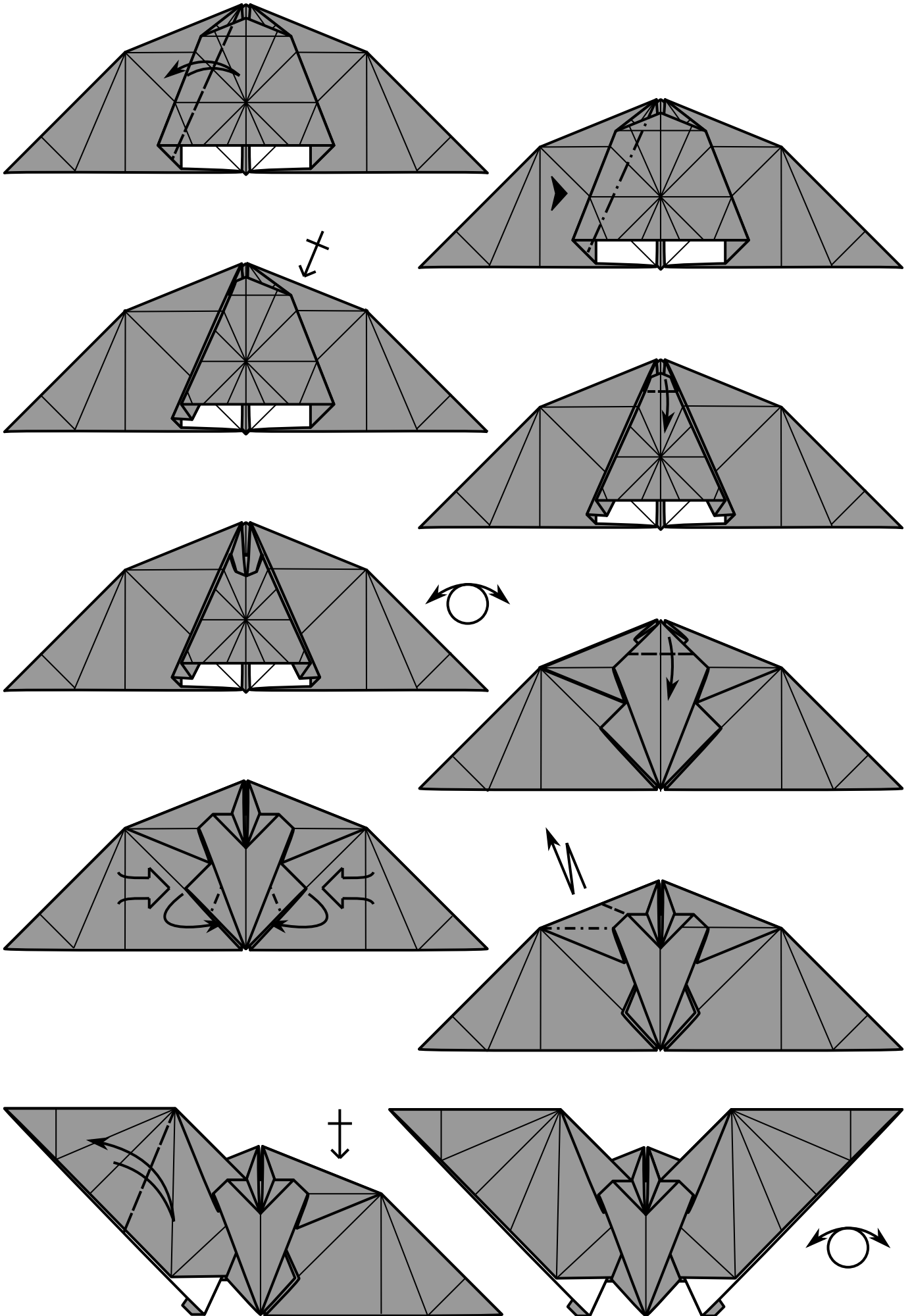

# The Bases of Folding

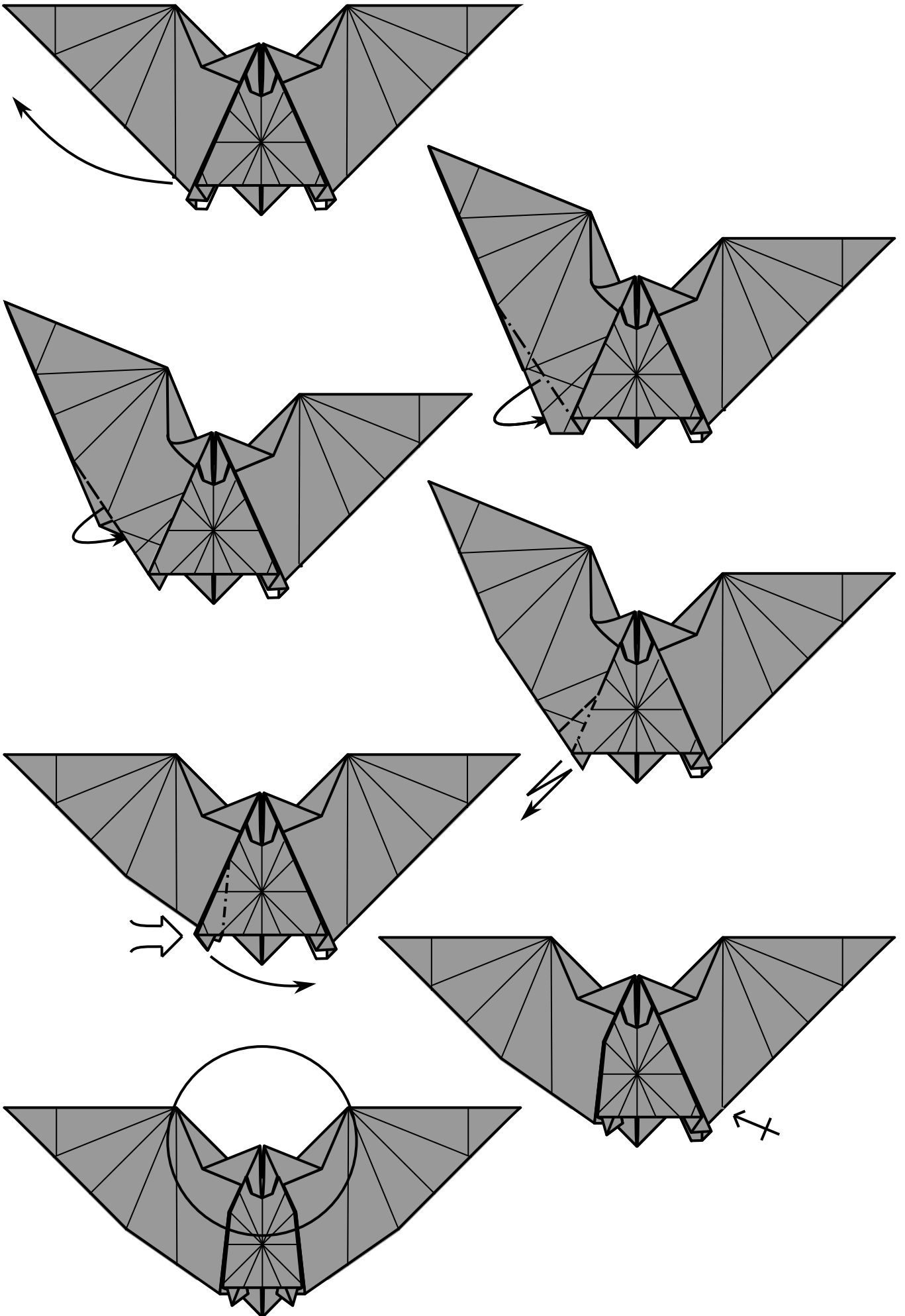

# The Bases of Folding

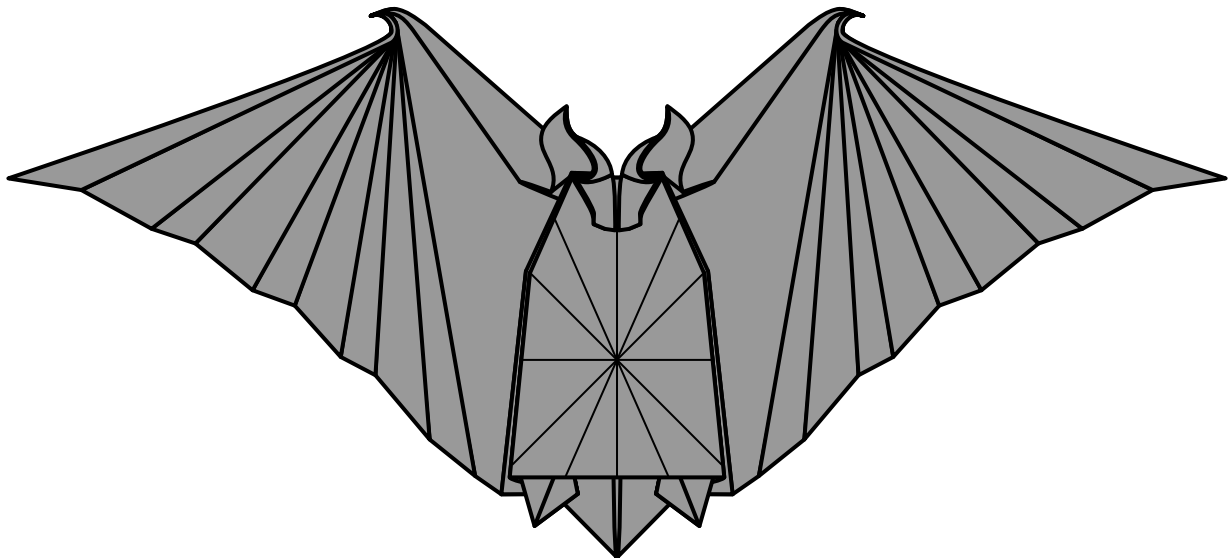
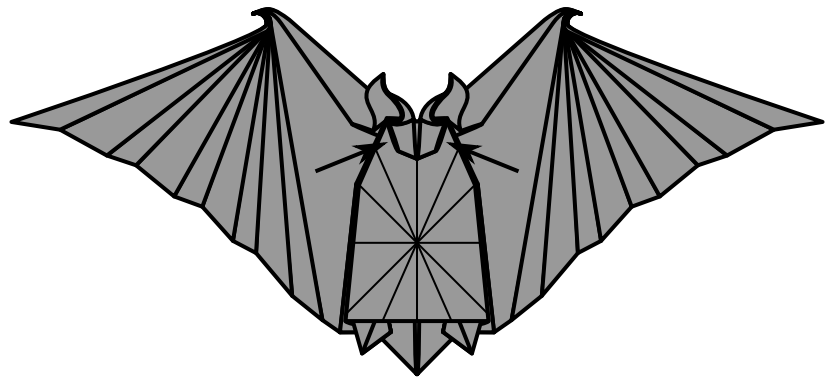
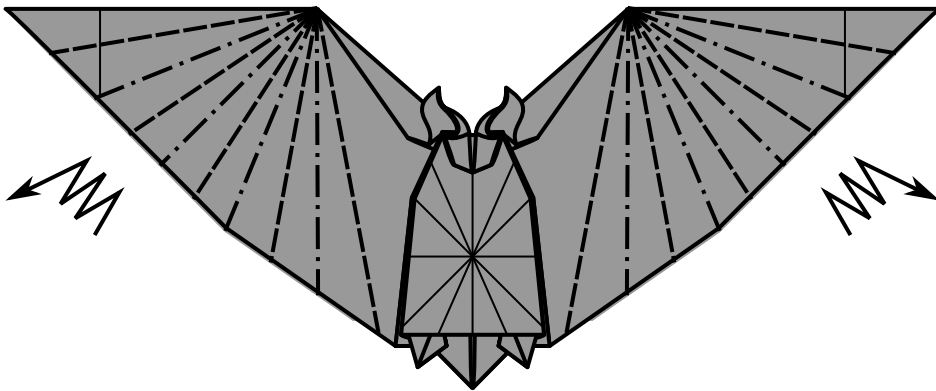
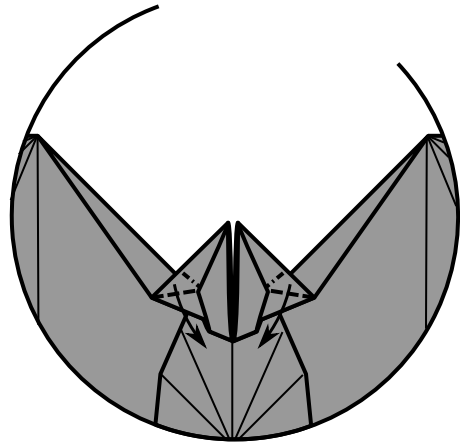
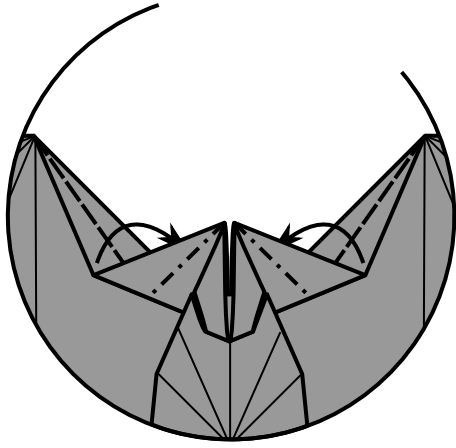

# Dolphin

I find that whenever I am in a slump, the best remedy is getting out of my own head and asking others for suggestions.

This model was the result of such an occasion, and once I was folding at the request of someone else, I found it much easier to get started.

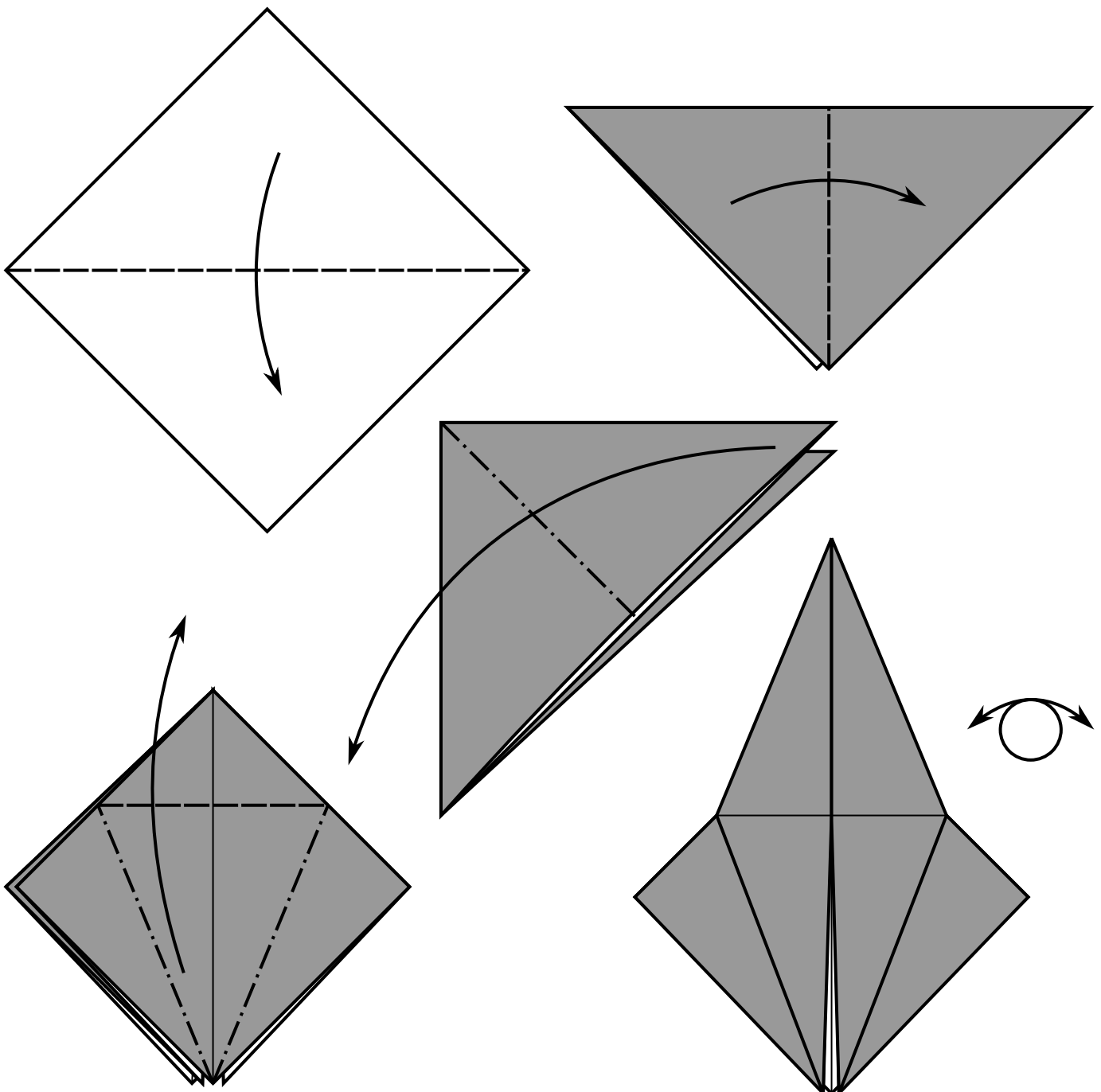

# The Bases of Folding

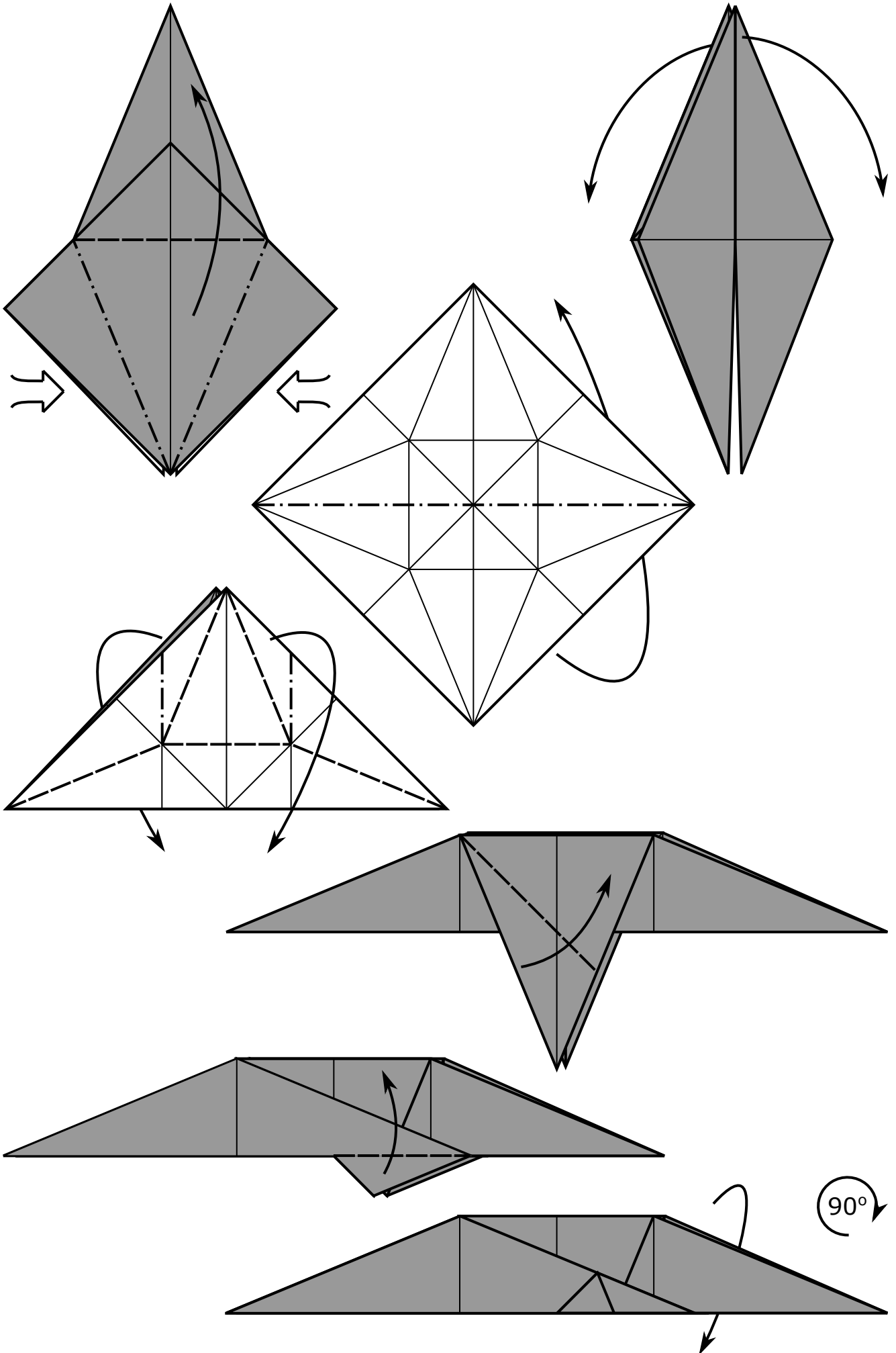



The Bases of Folding

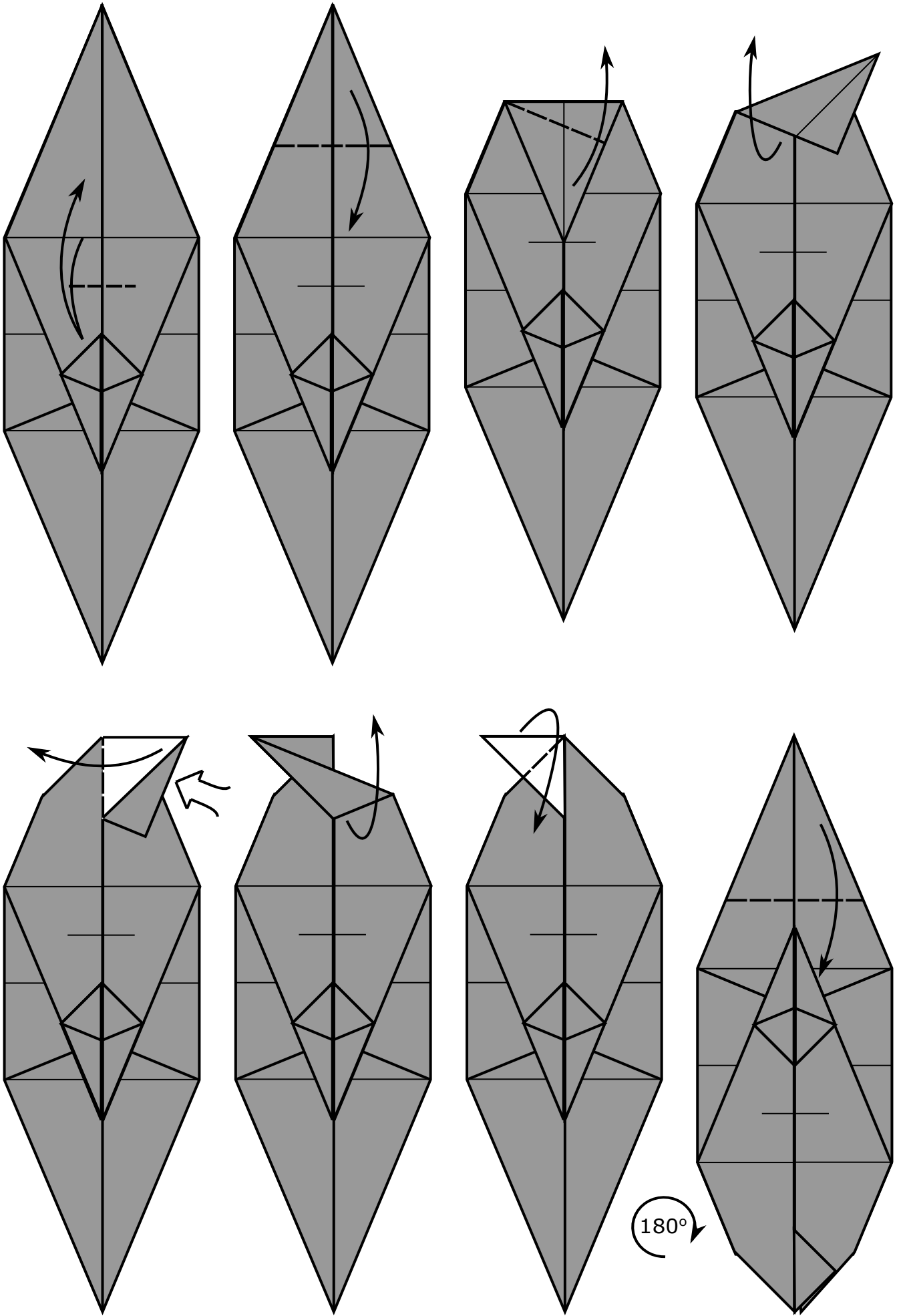

# The Bases of Folding

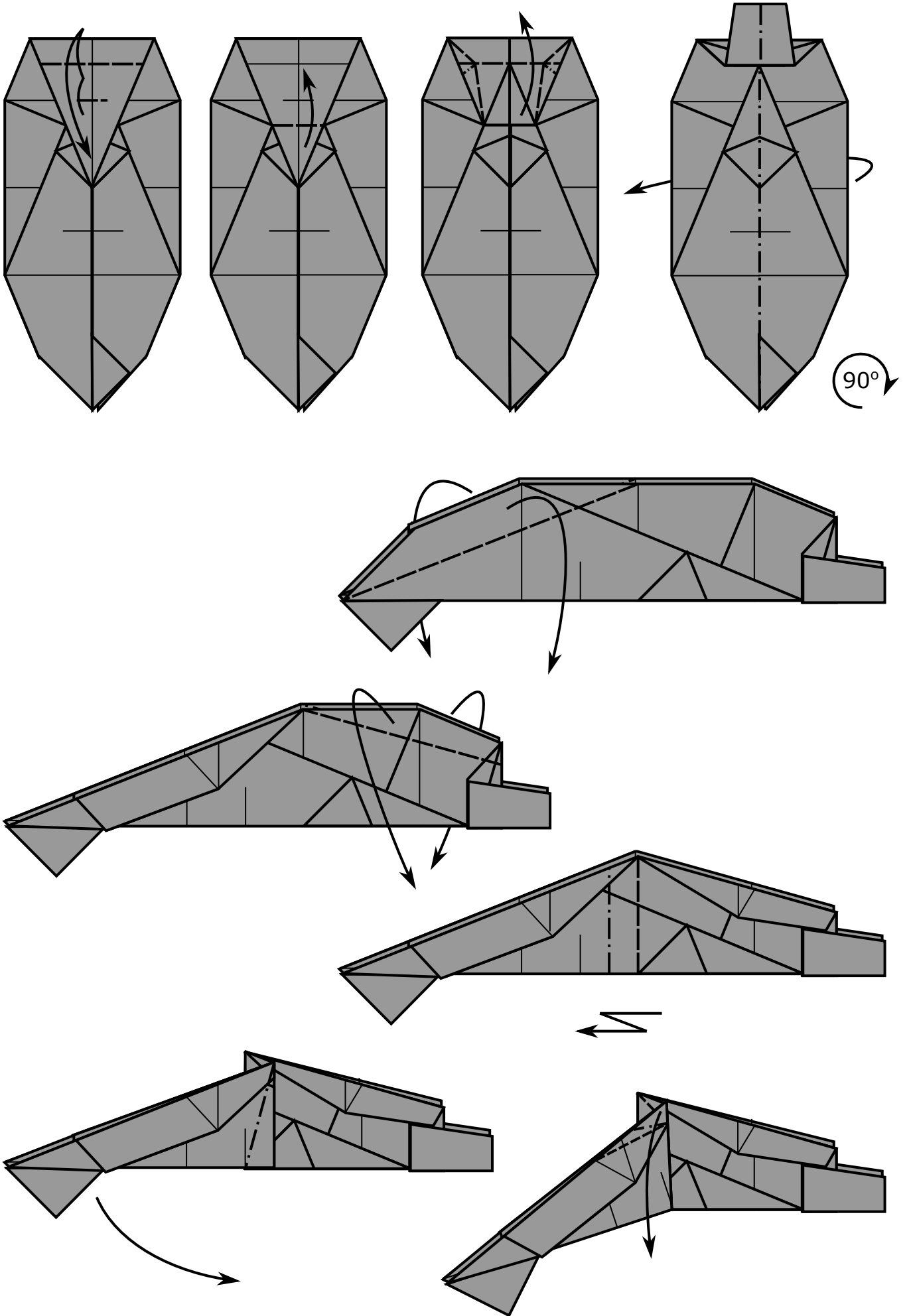

# The Bases of Folding

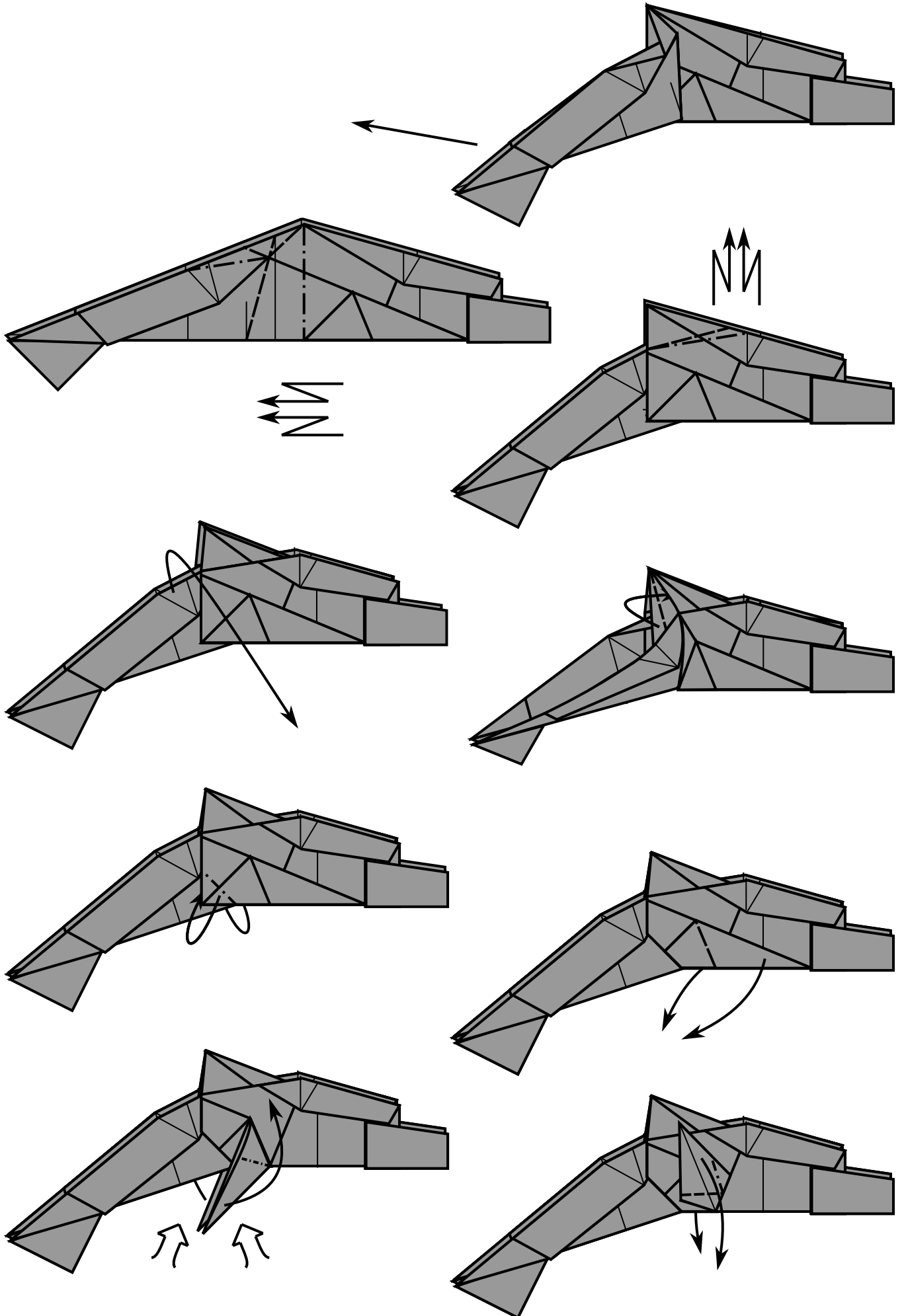

# The Bases of Folding

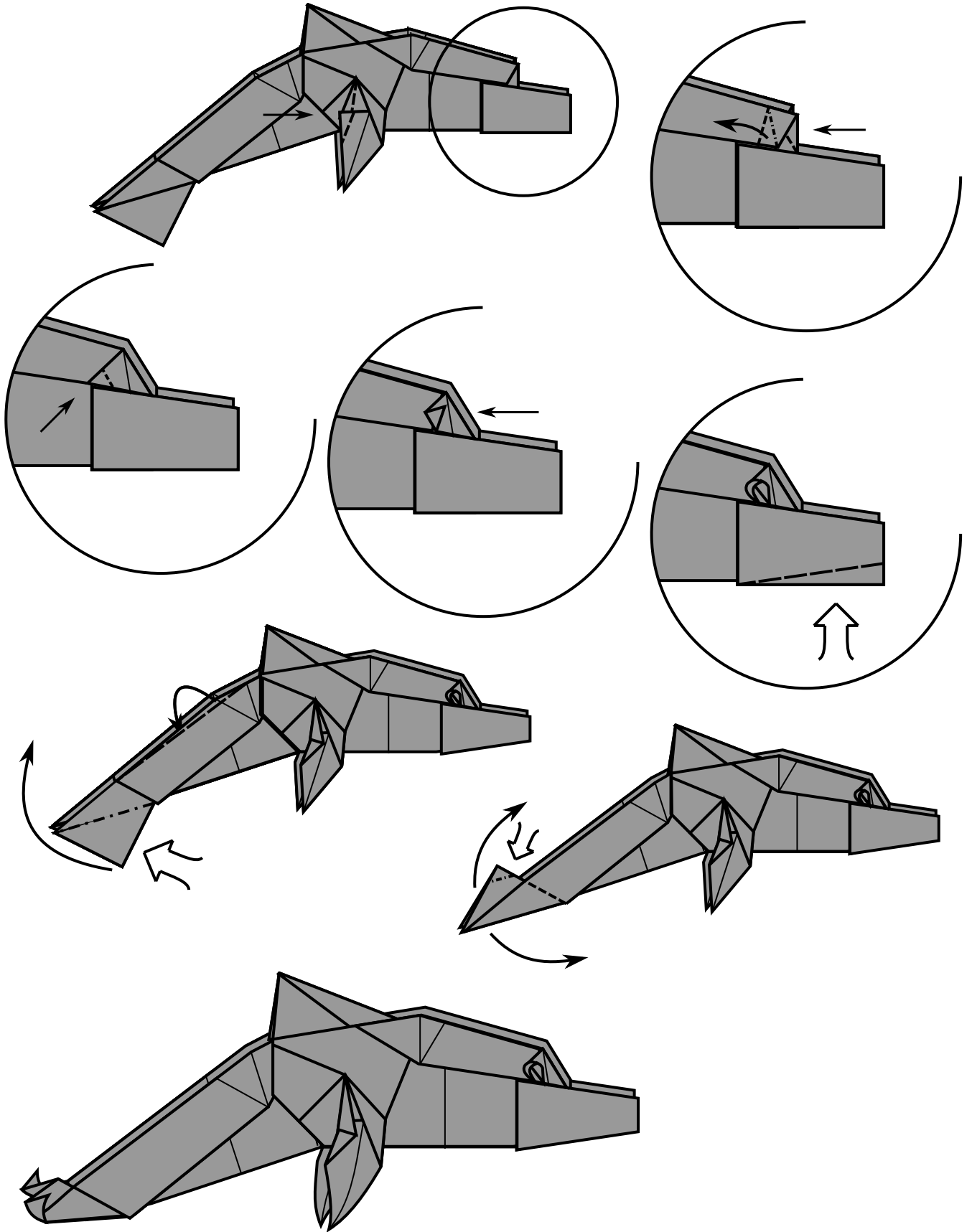

# Shark

While accepting constructive criticism is vital to improving your skills, sometimes it's just as important to stay true to your convictions.

The first draft of this model received criticism for its sinks and the central locking mechanism, but I kept them because I find them unique and fun to fold.

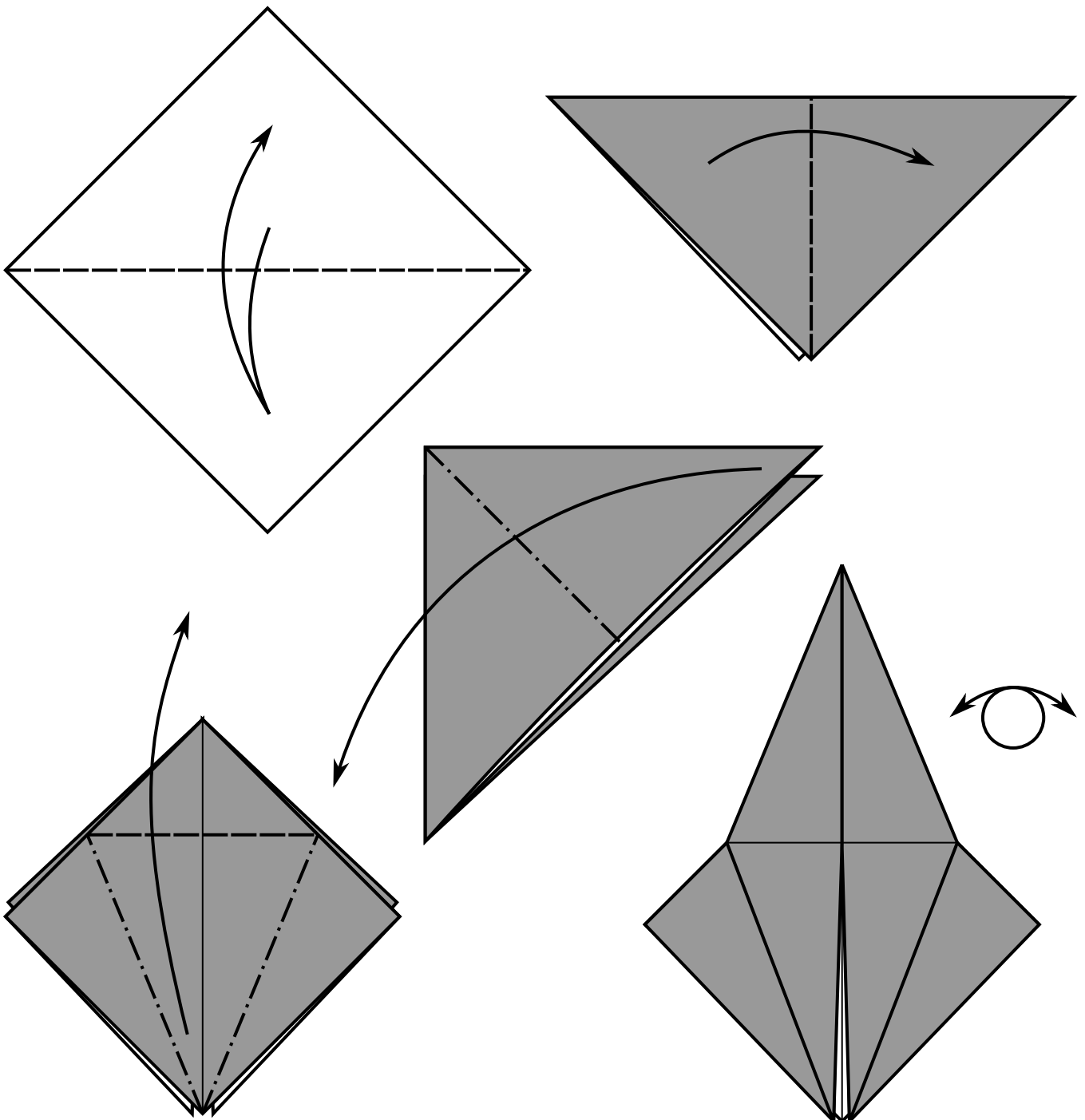
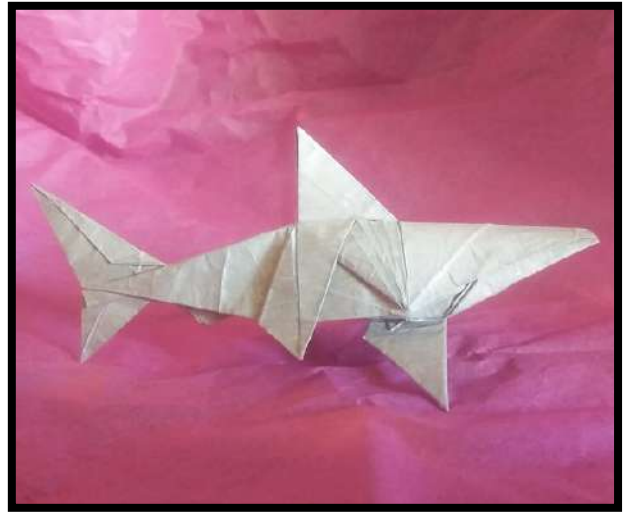

# The Bases of Folding

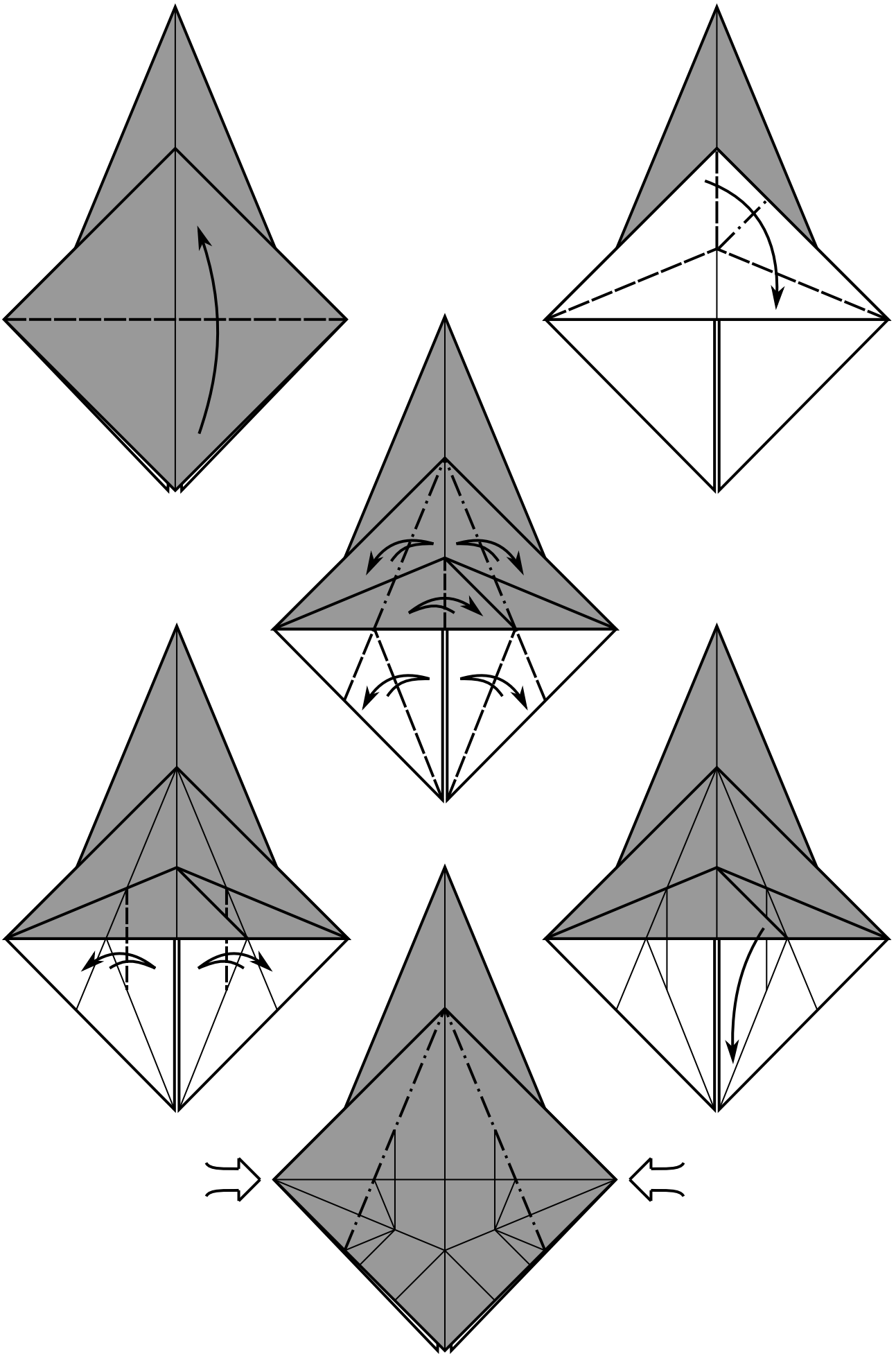

# The Bases of Folding

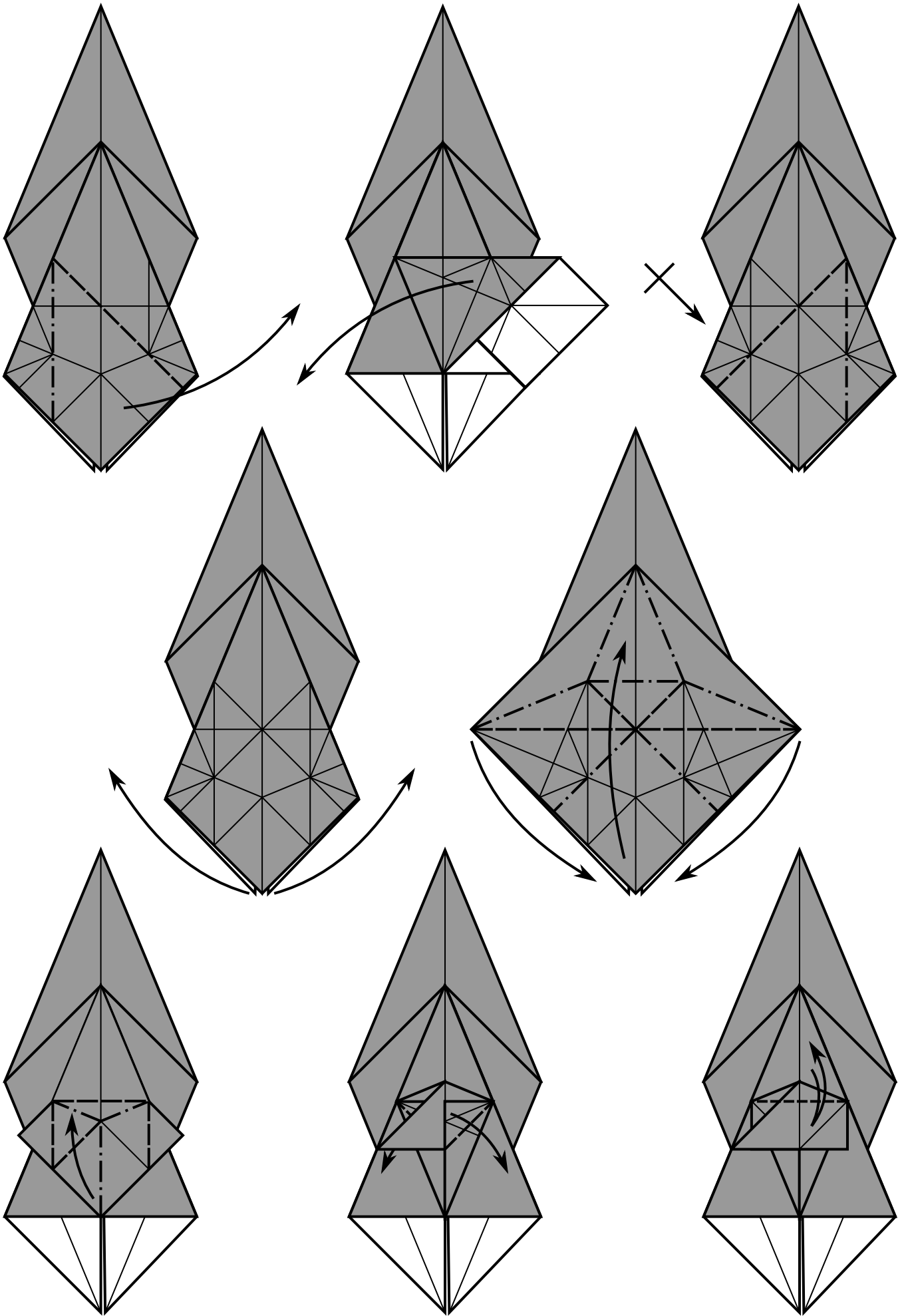

# The Bases of Folding

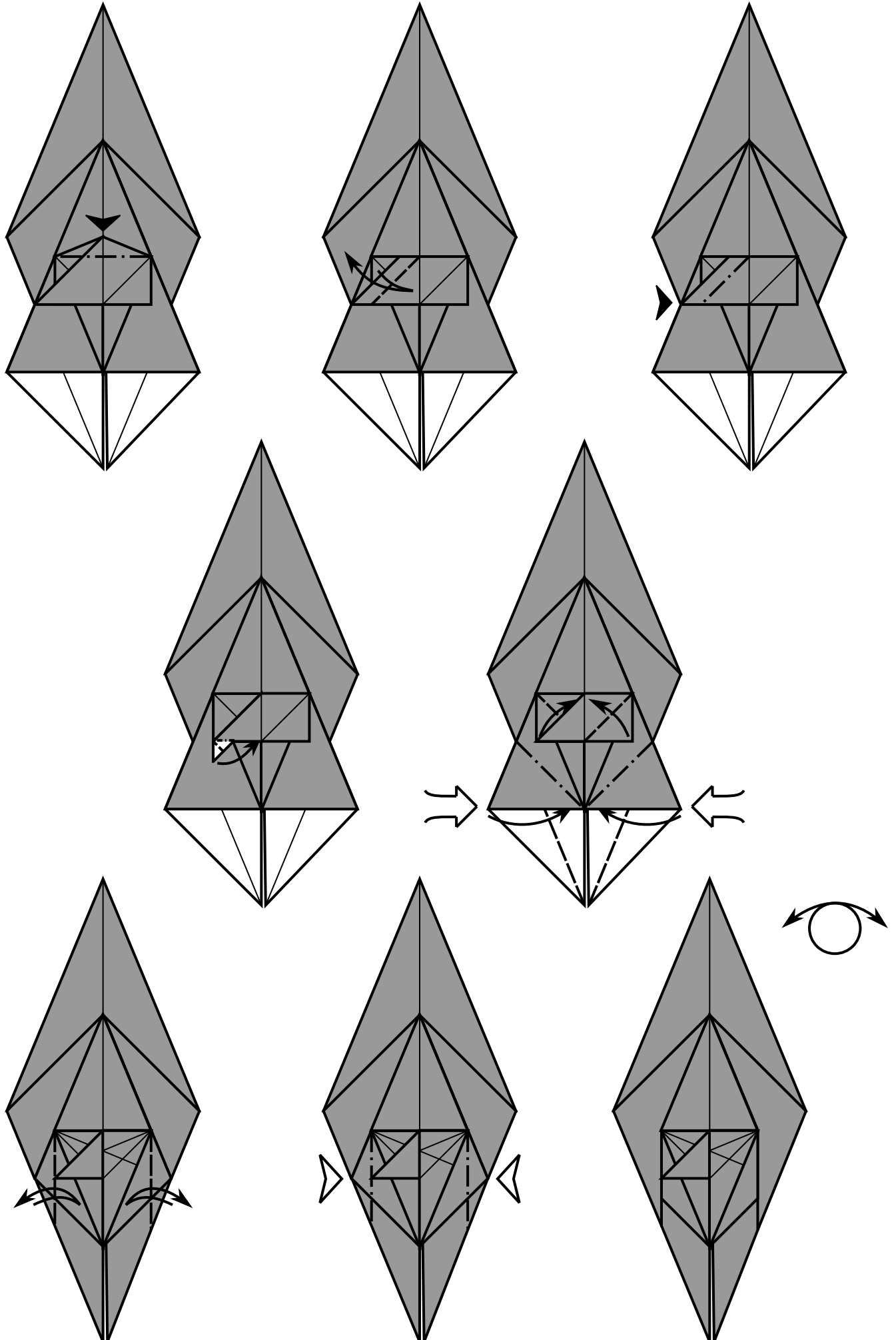



# The Bases of Folding

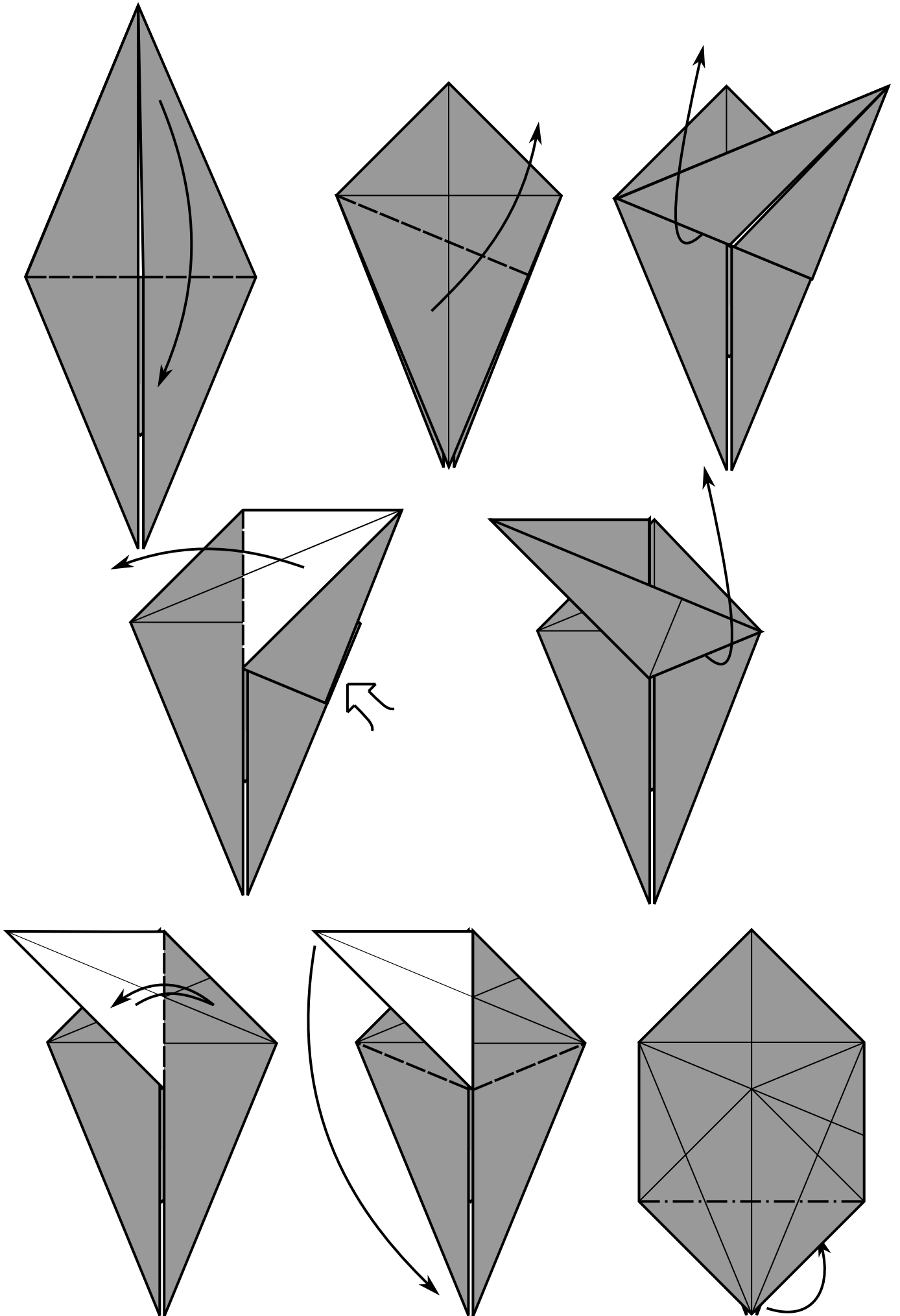

The Bases of Folding

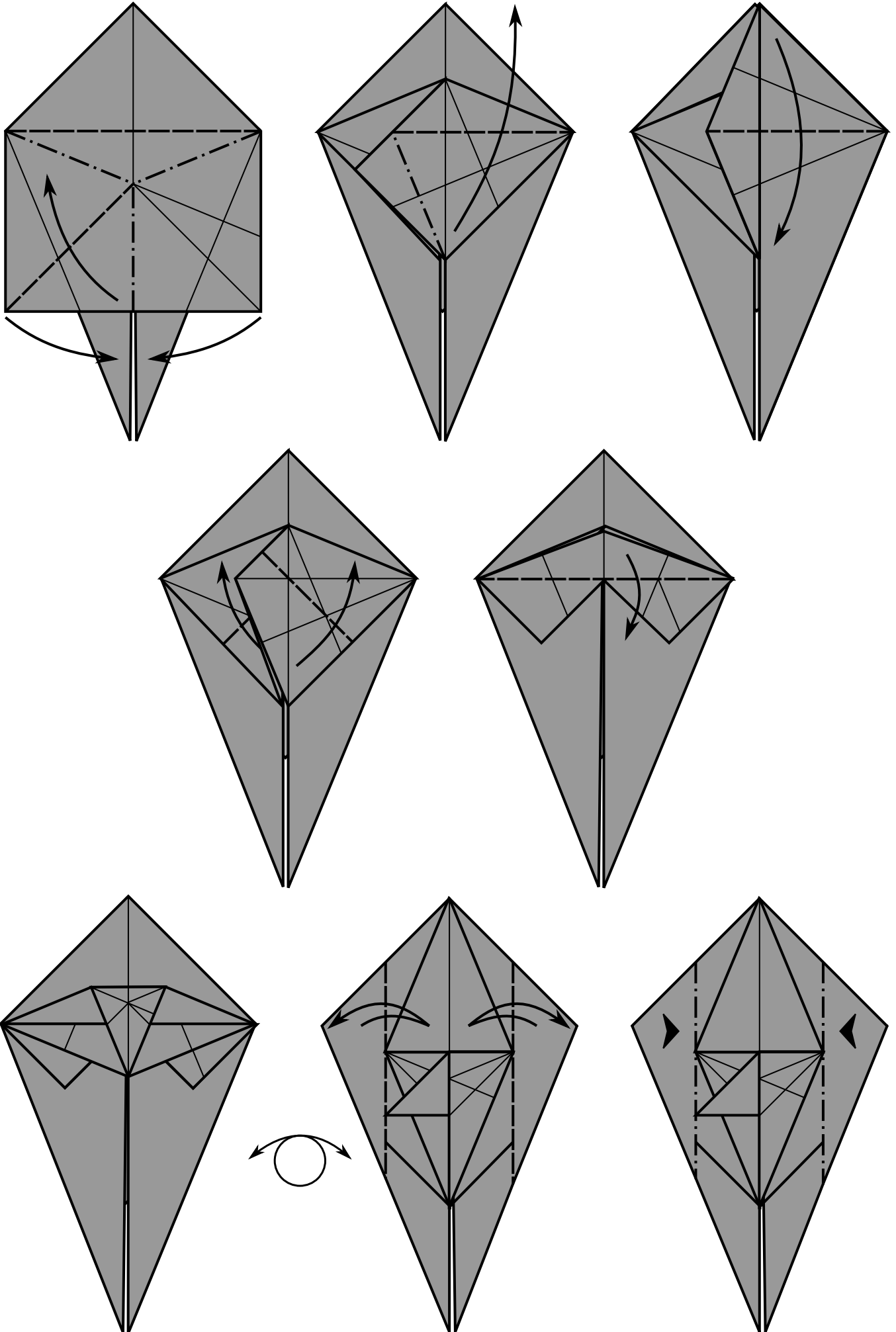

The Bases of Folding

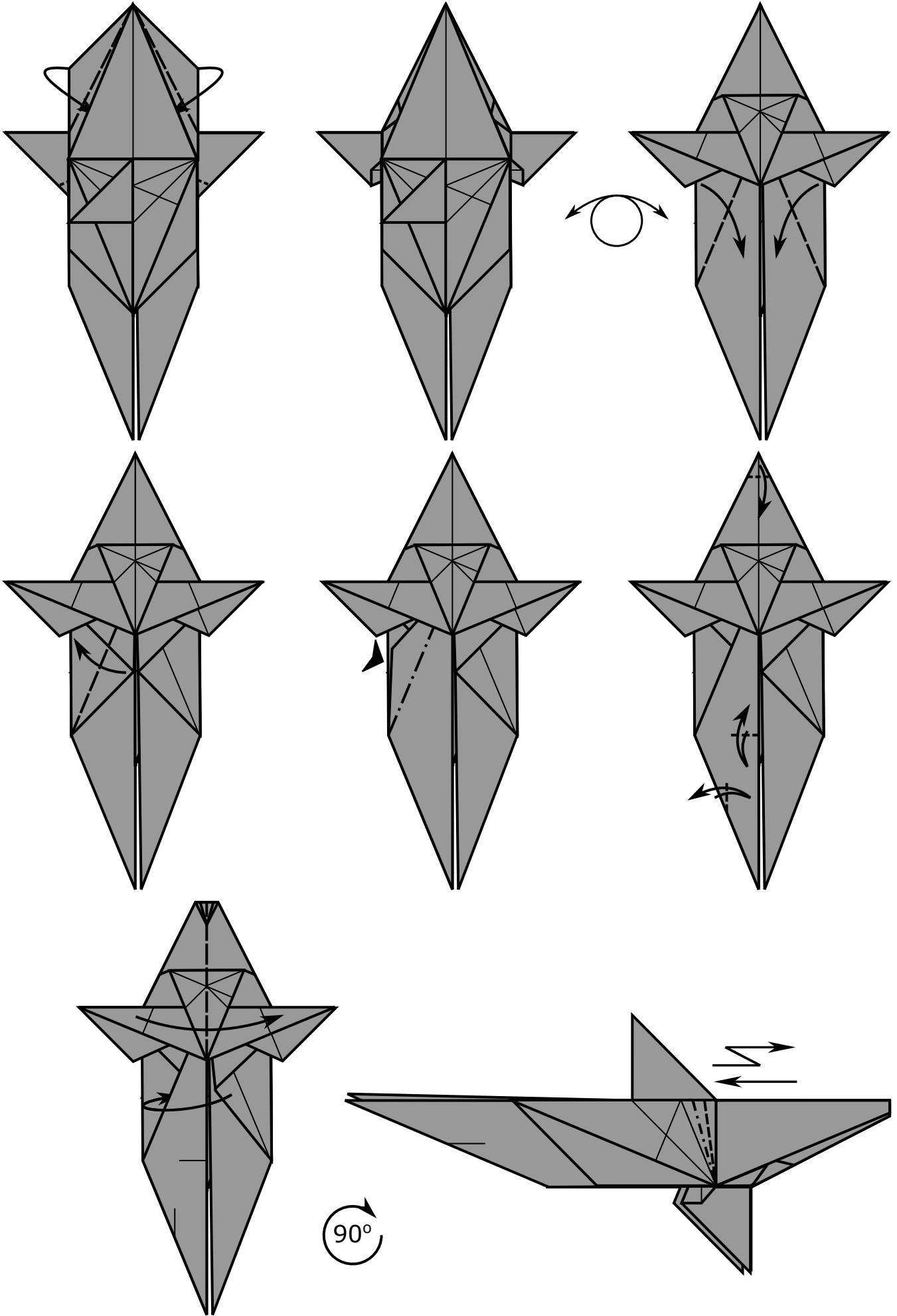

# The Bases of Folding

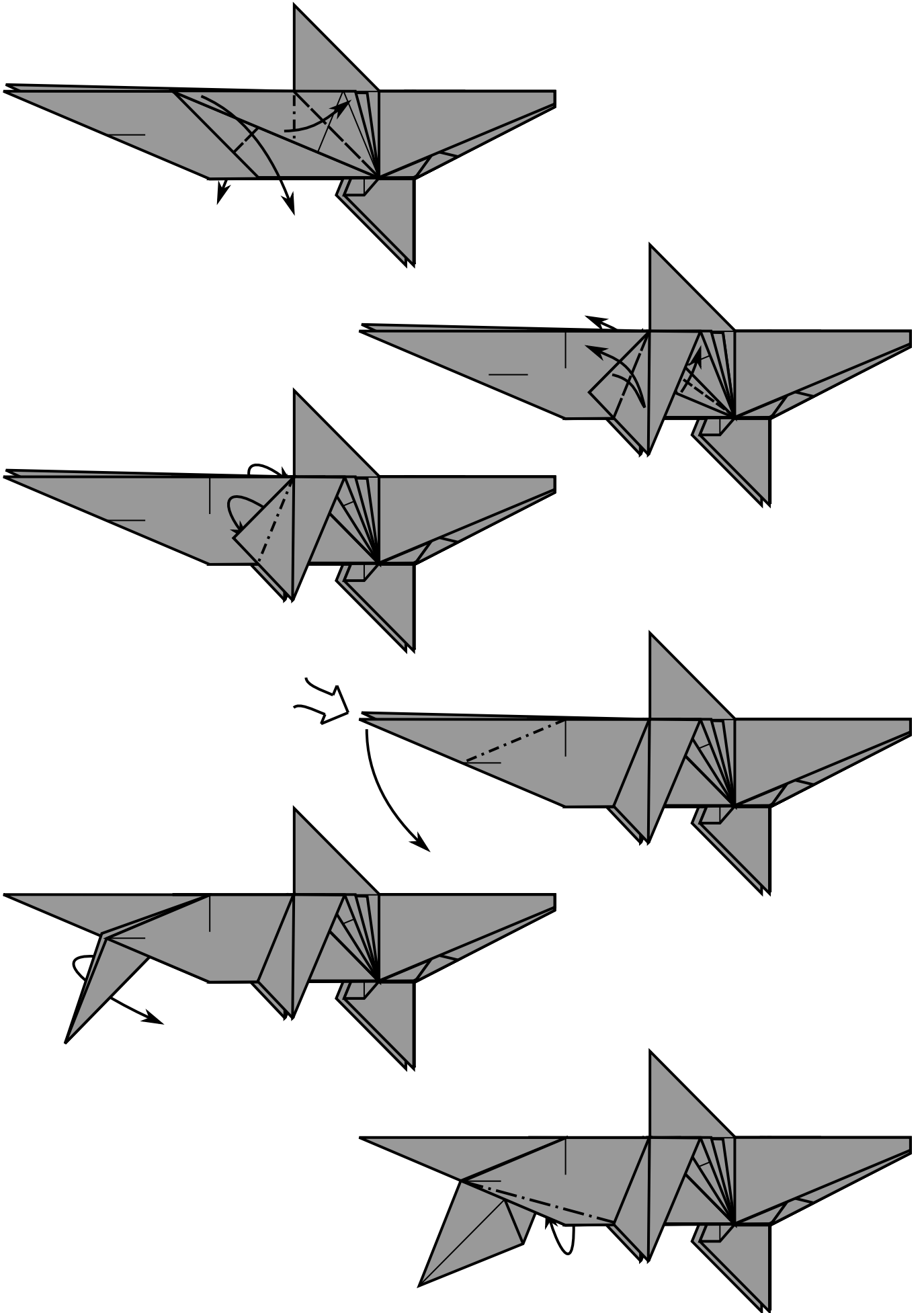

The Bases of Folding

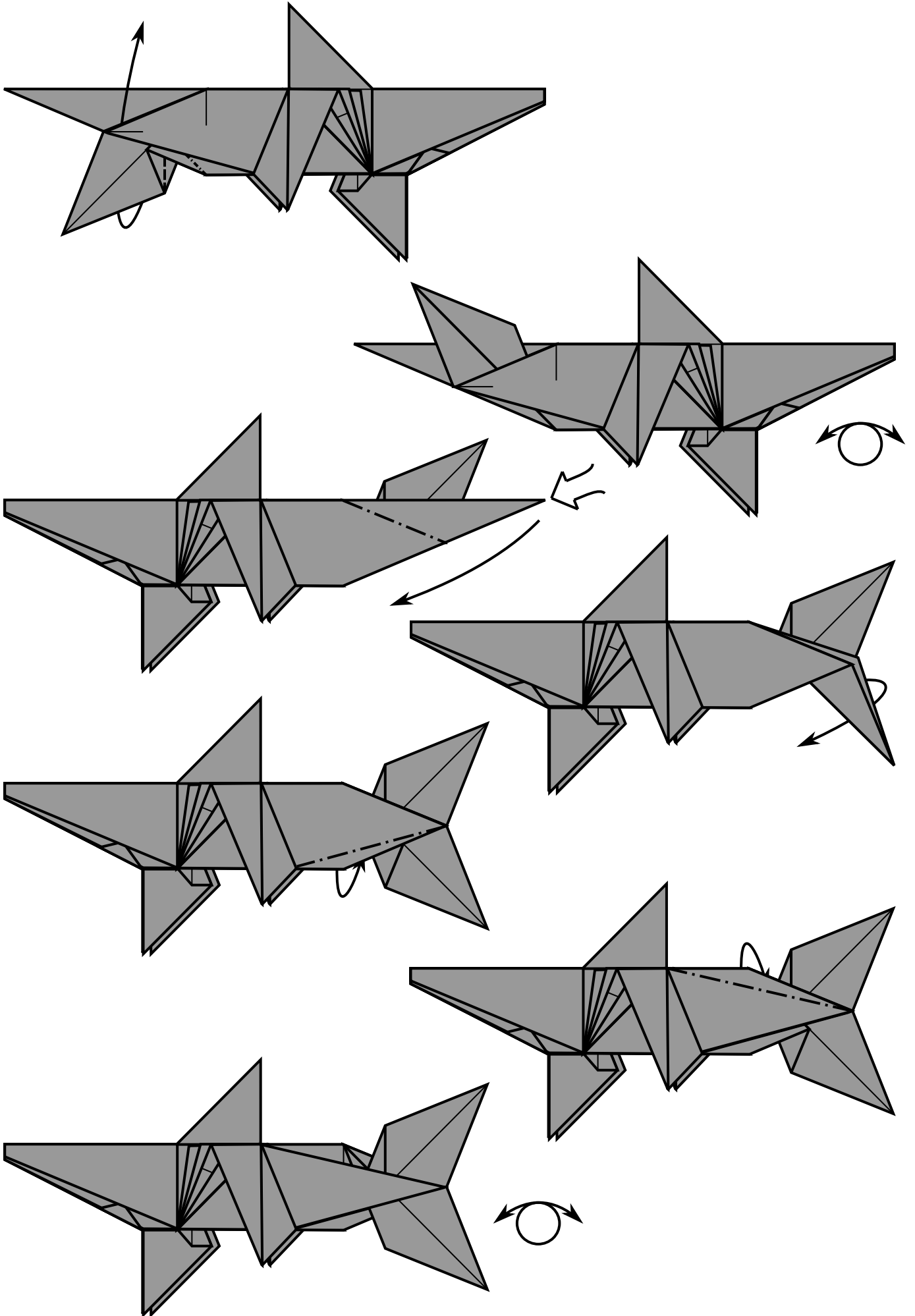

The Bases of Folding

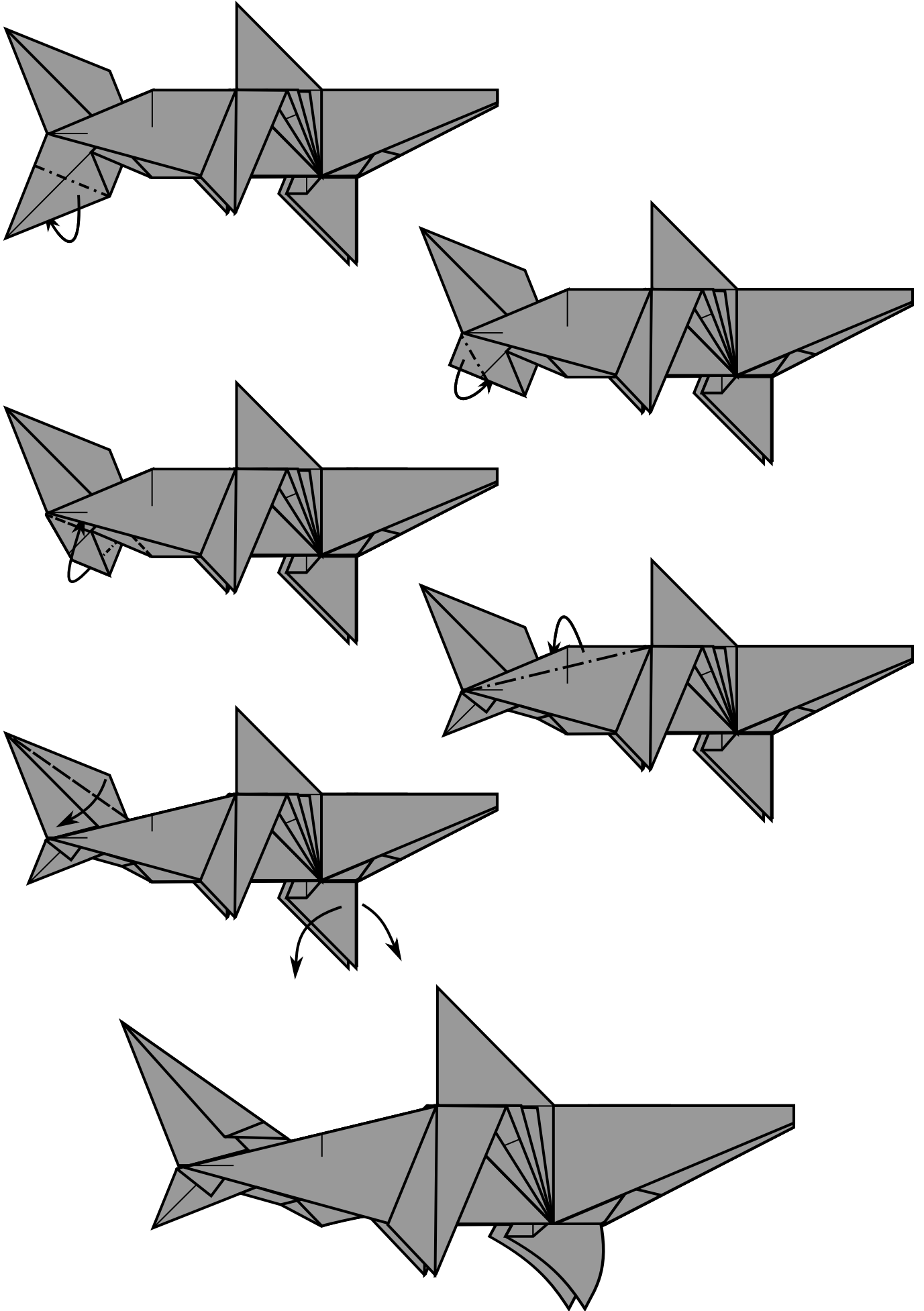

# Seahorse

While ignoring criticism is sometimes warranted, you can miss out on valuable growth if you do so without caution.

When I first posted this online, I received a lot of harsh criticism. Although most of it was typical internet trolling, some contained a fair bit of helpful advice. Had I written everything off, I would've never improved this model.

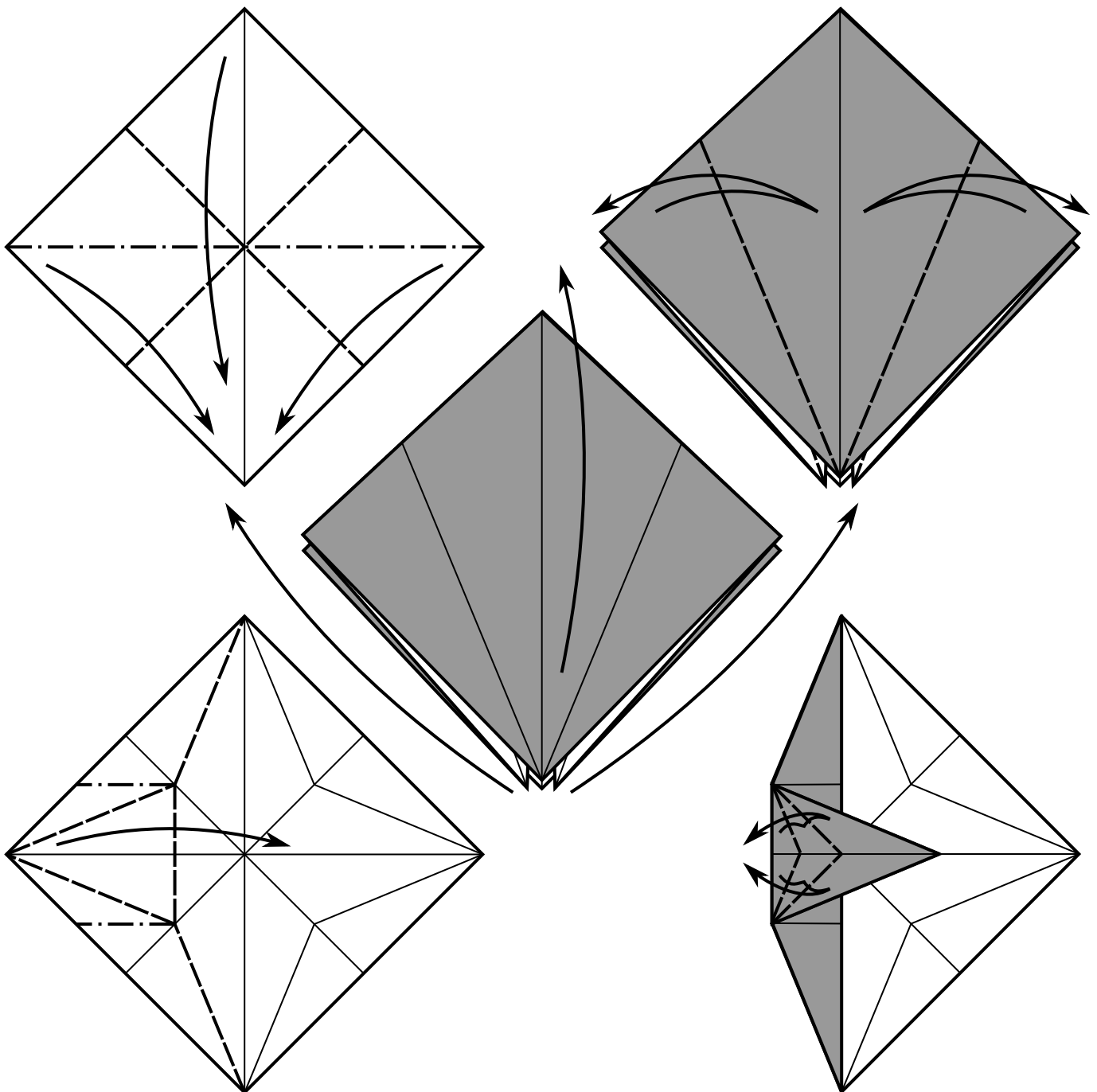

# The Bases of Folding

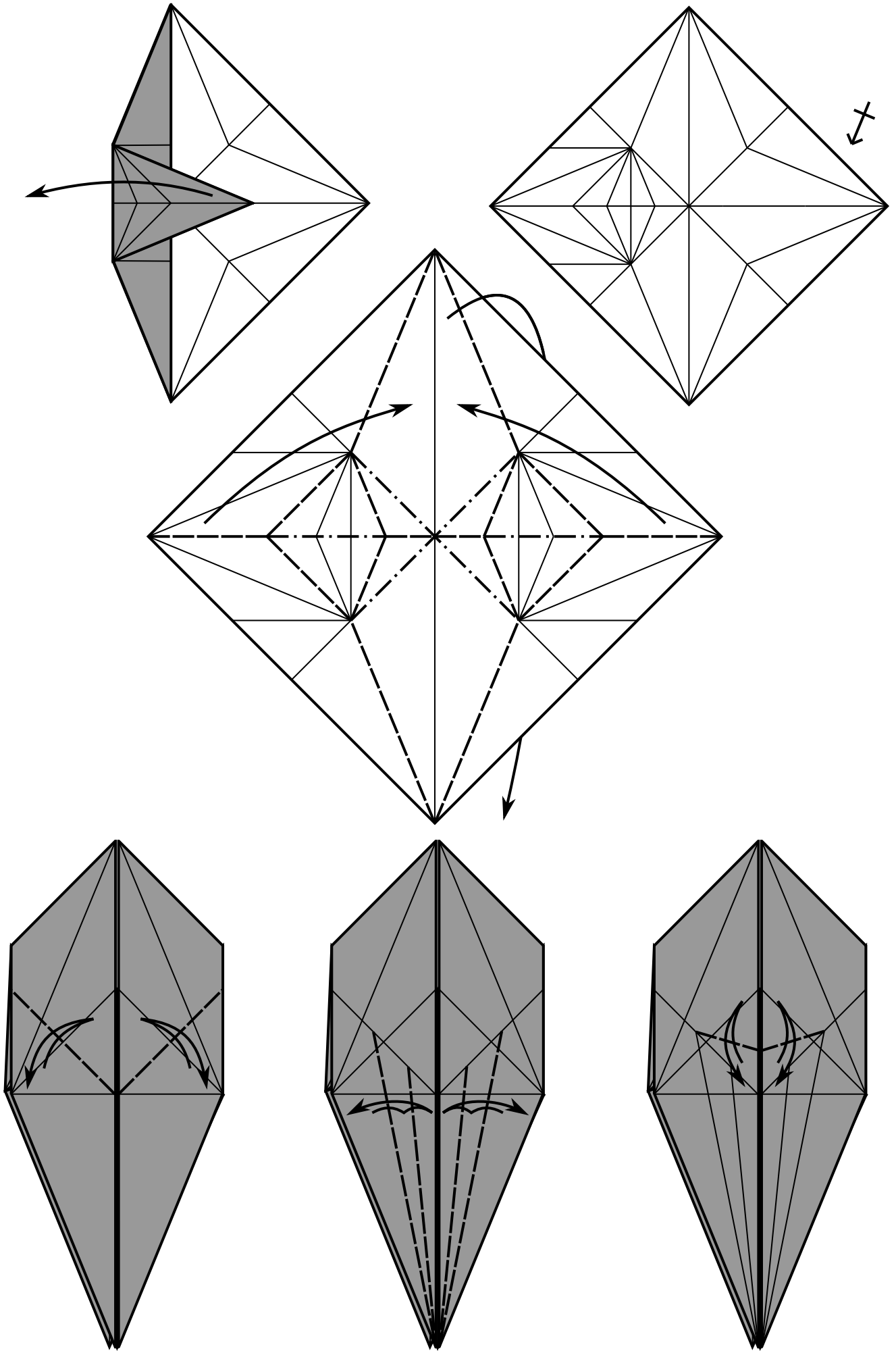



The Bases of Folding

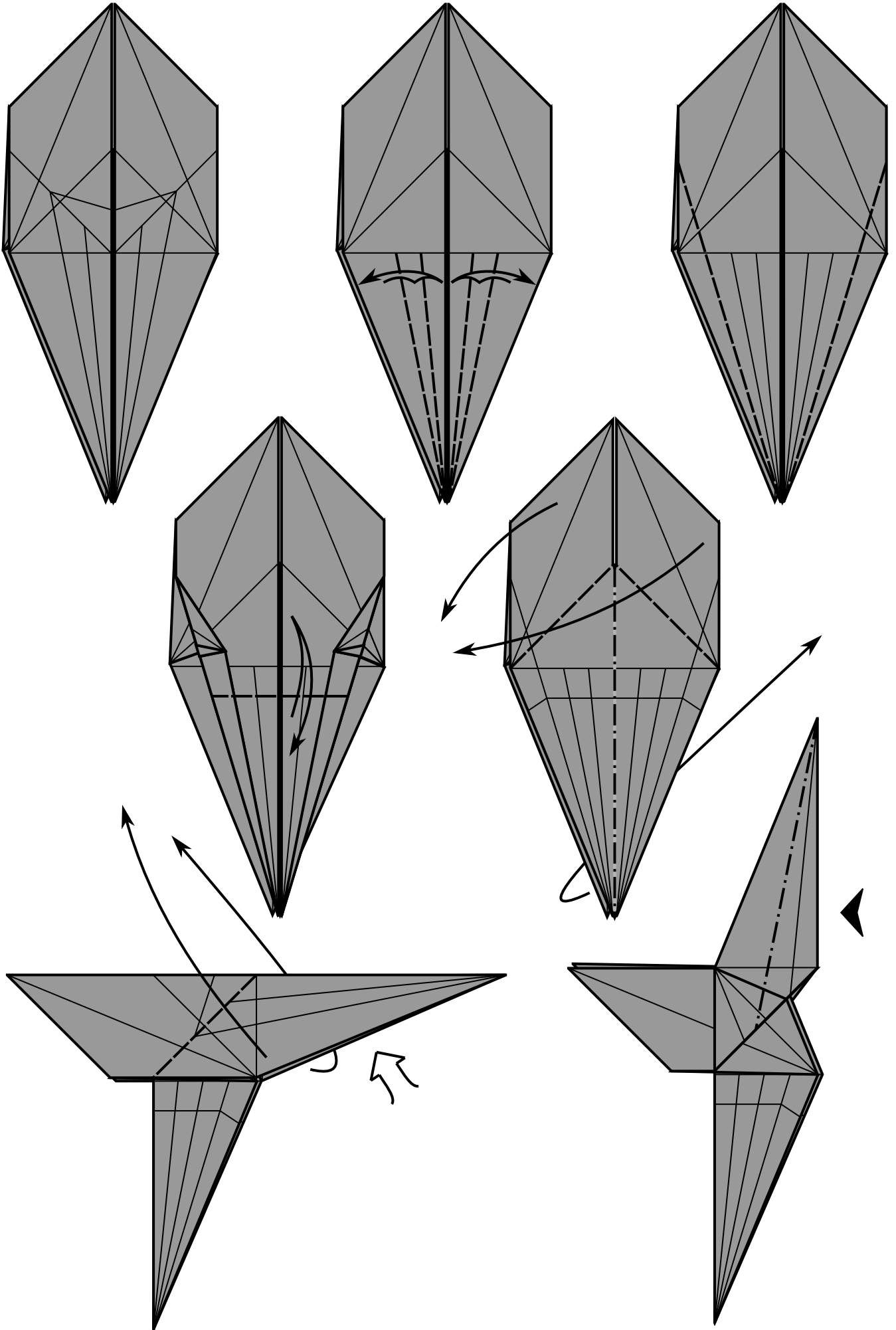

# The Bases of Folding

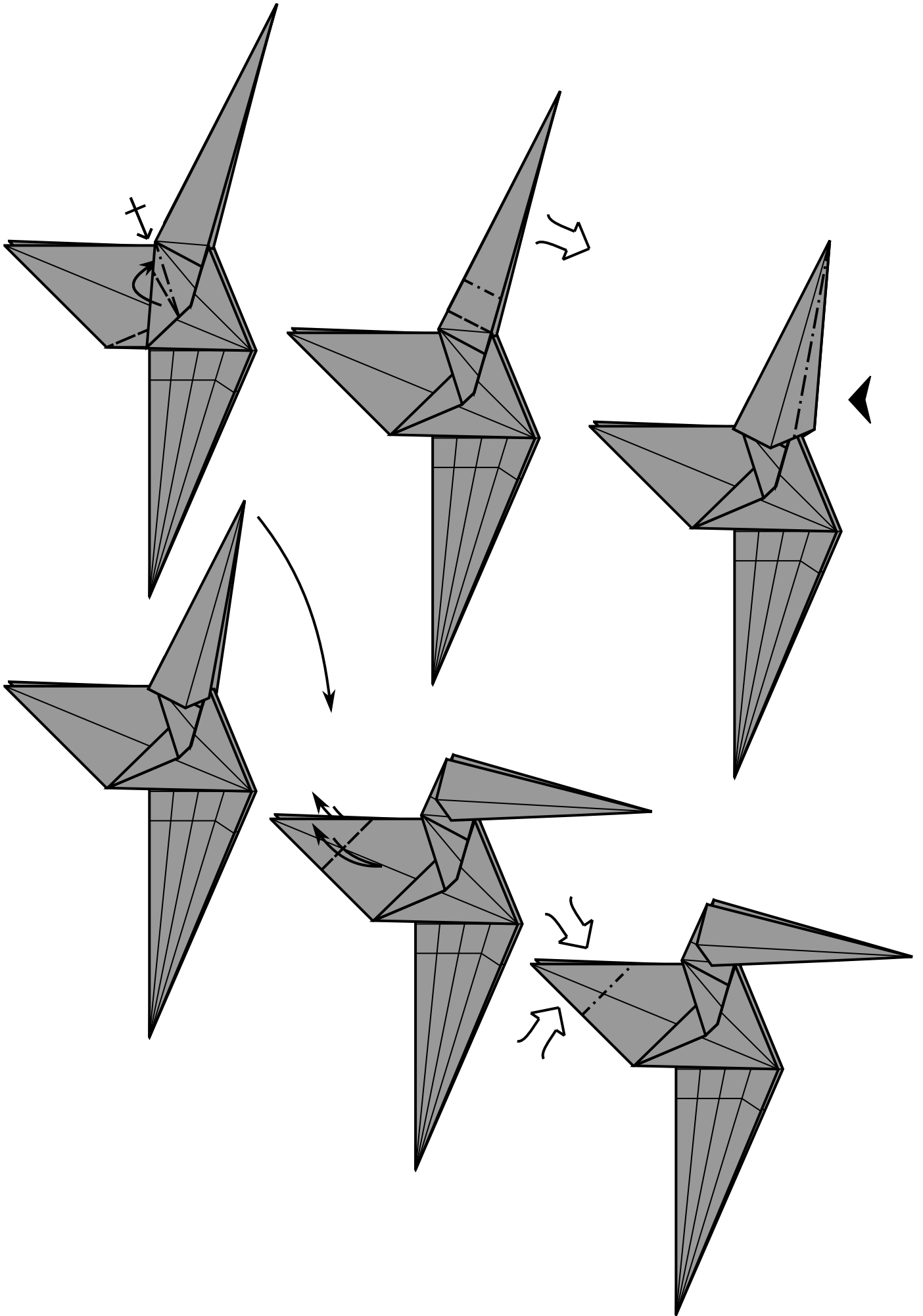

The Bases of Folding

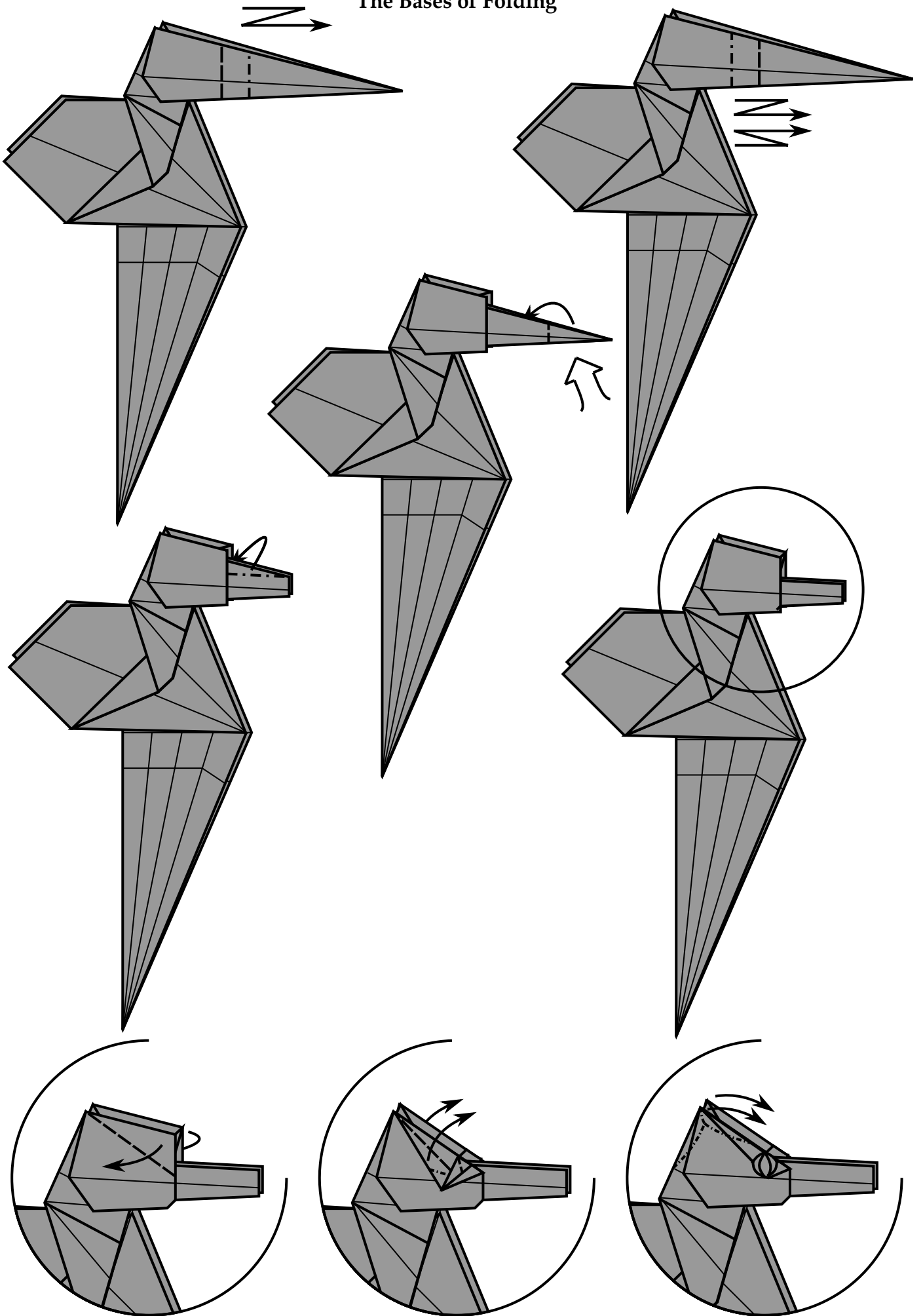

The Bases of Folding

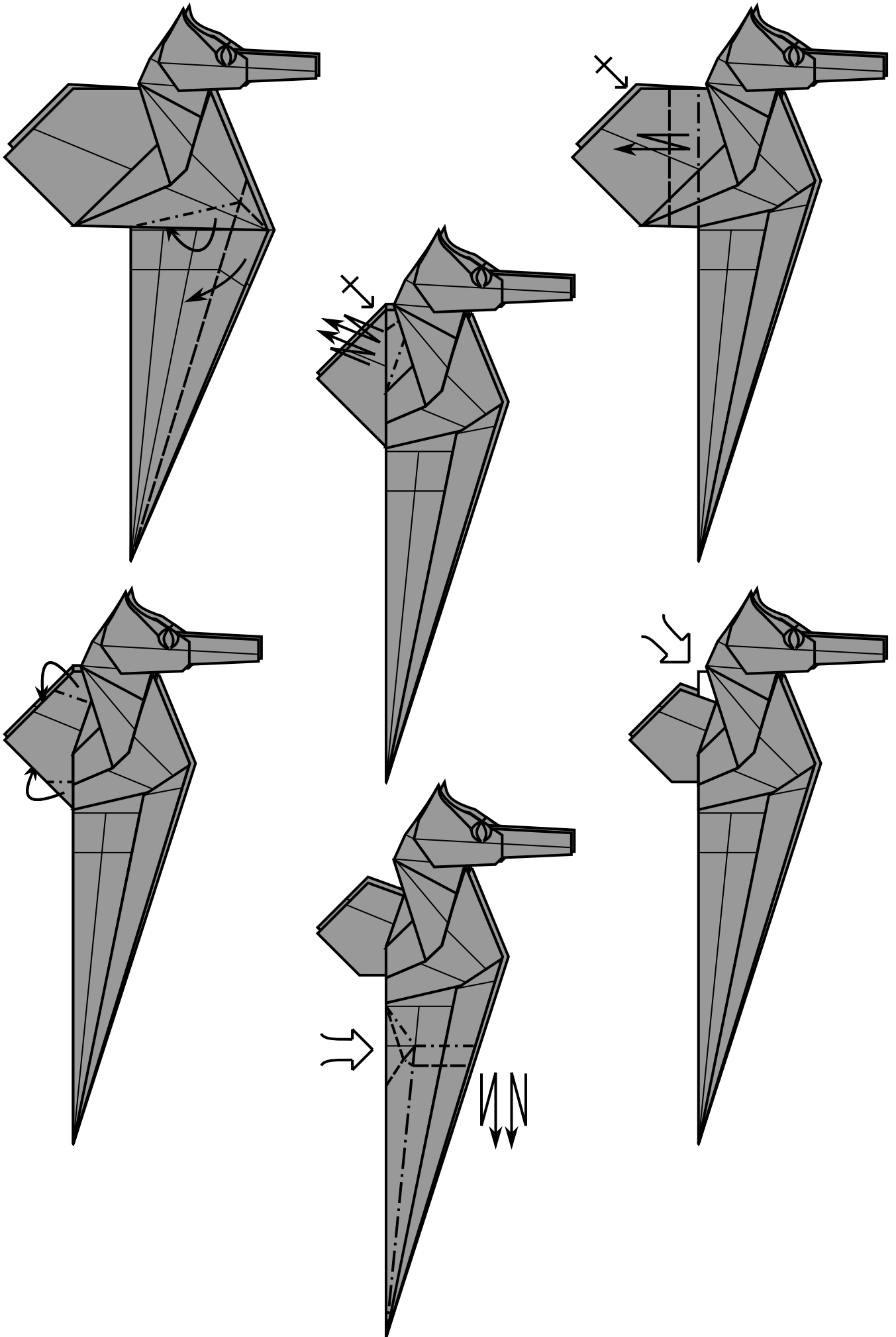

The Bases of Folding

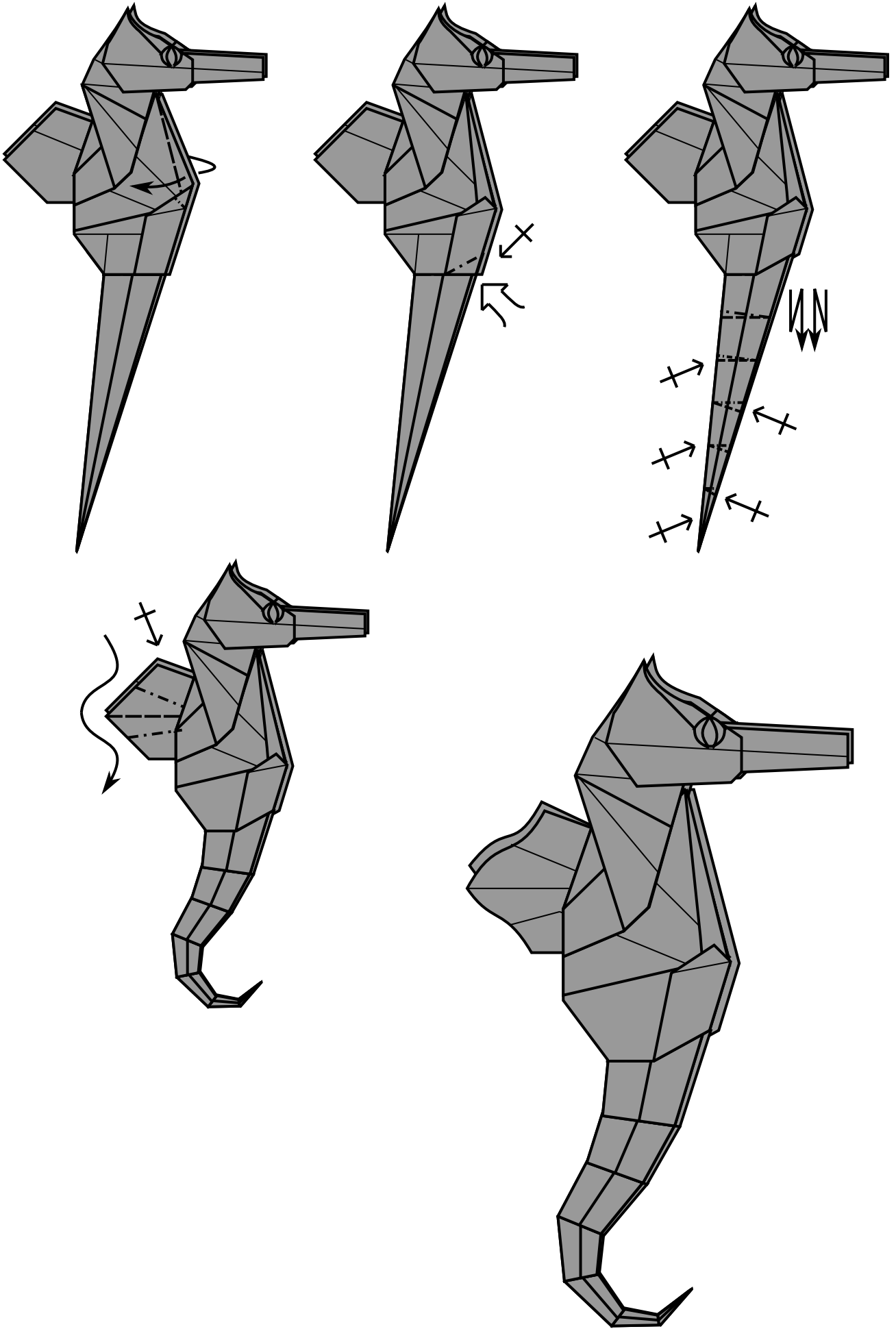

# Sheep

"The only thing we have to fear is fear itself." This famous quote from FDR not only implies we should have no fear, but that we should also confront any fears we do have.

If you've noticed there are mainly sea creatures in this book, there's a simple explanation: I'm terrible at making legs. I decided to overcome my fear with this sheep. They may just be sticks, but it's a start, right?

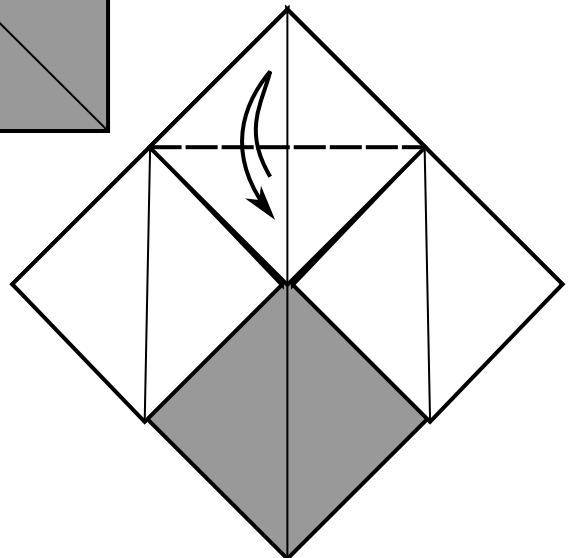
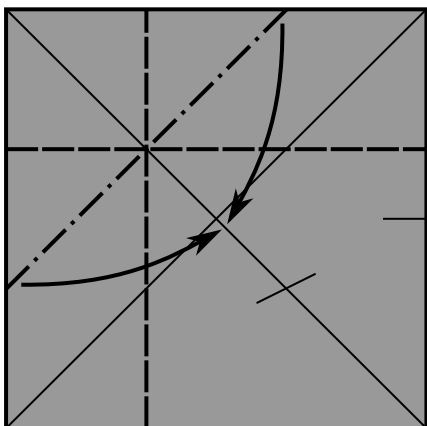
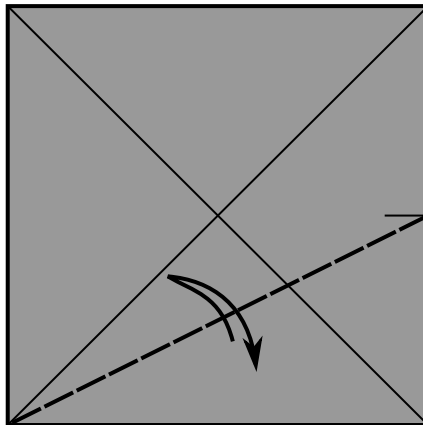
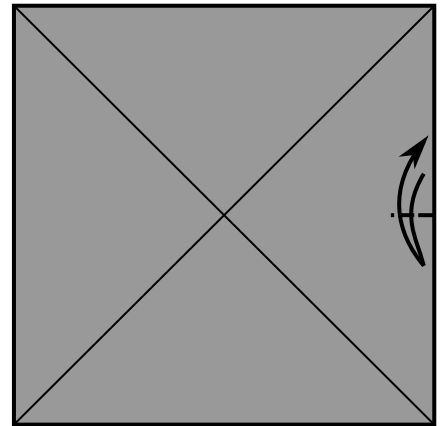
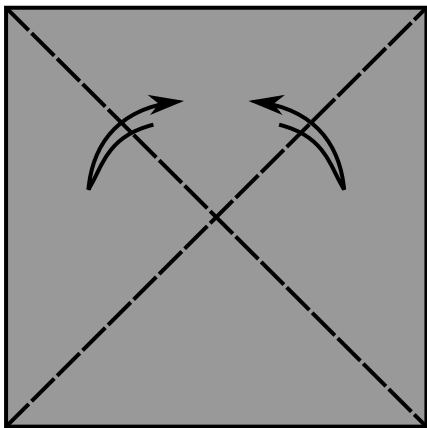

# The Bases of Folding

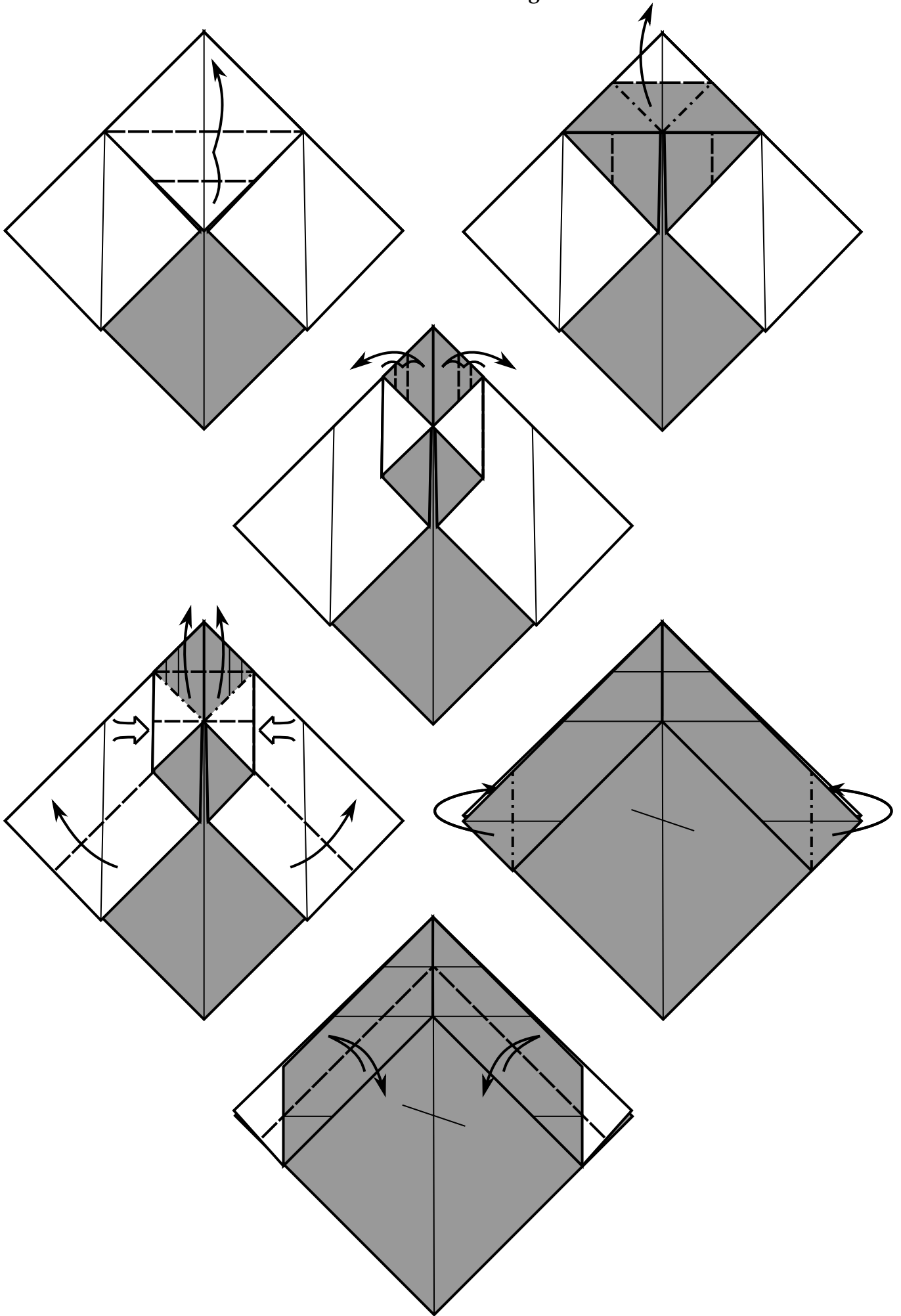

# The Bases of Folding

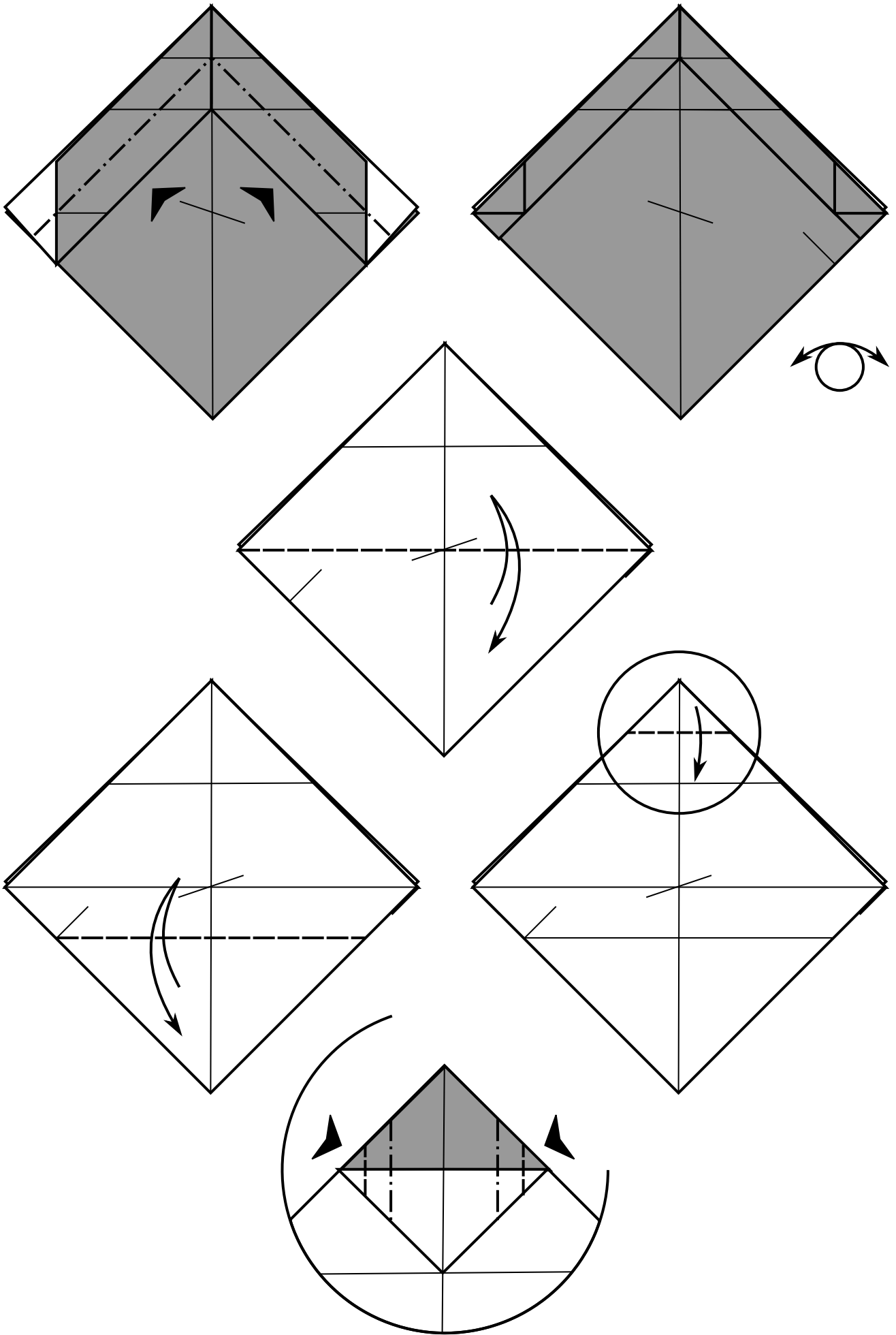



# The Bases of Folding

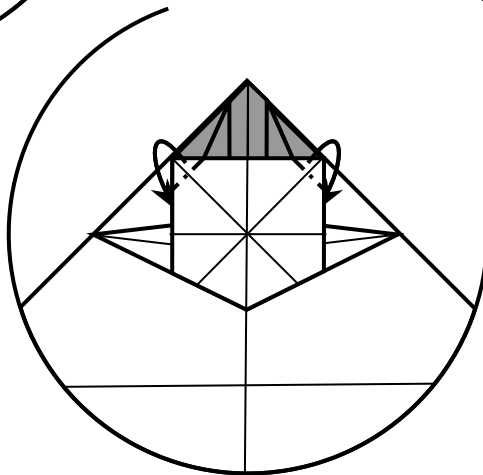
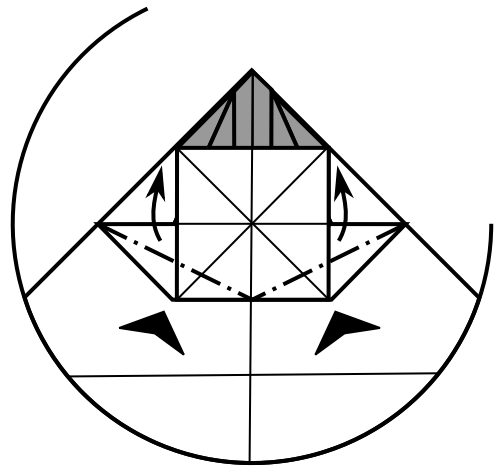
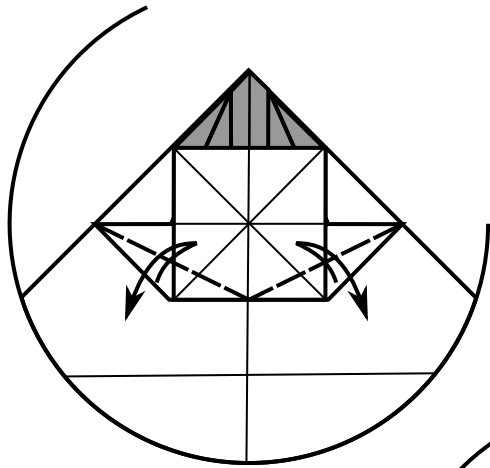
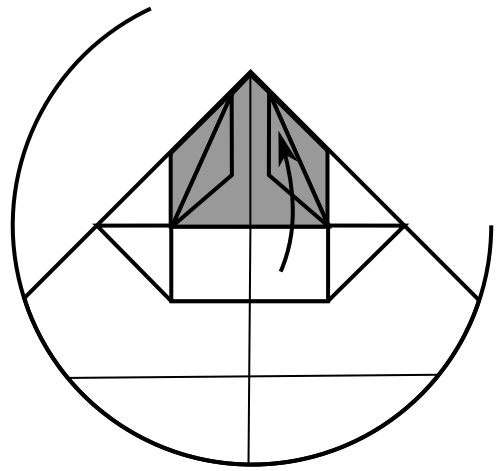
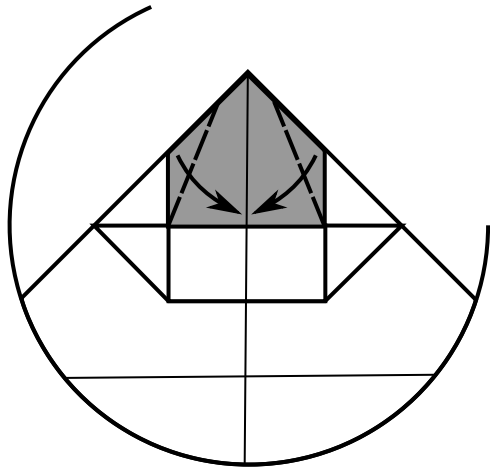
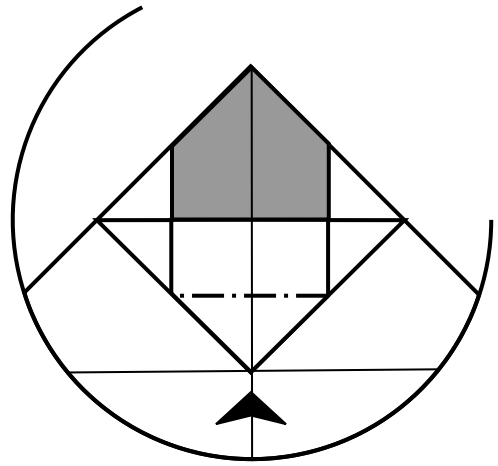
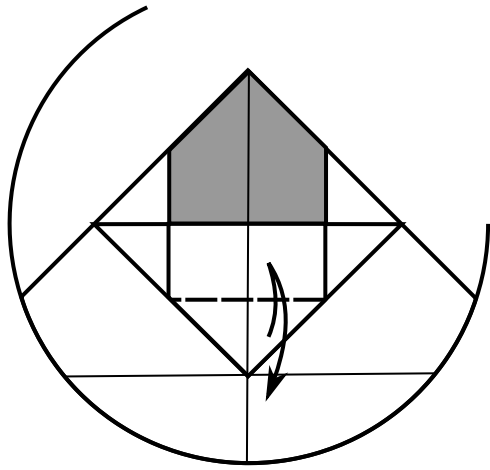

# The Bases of Folding

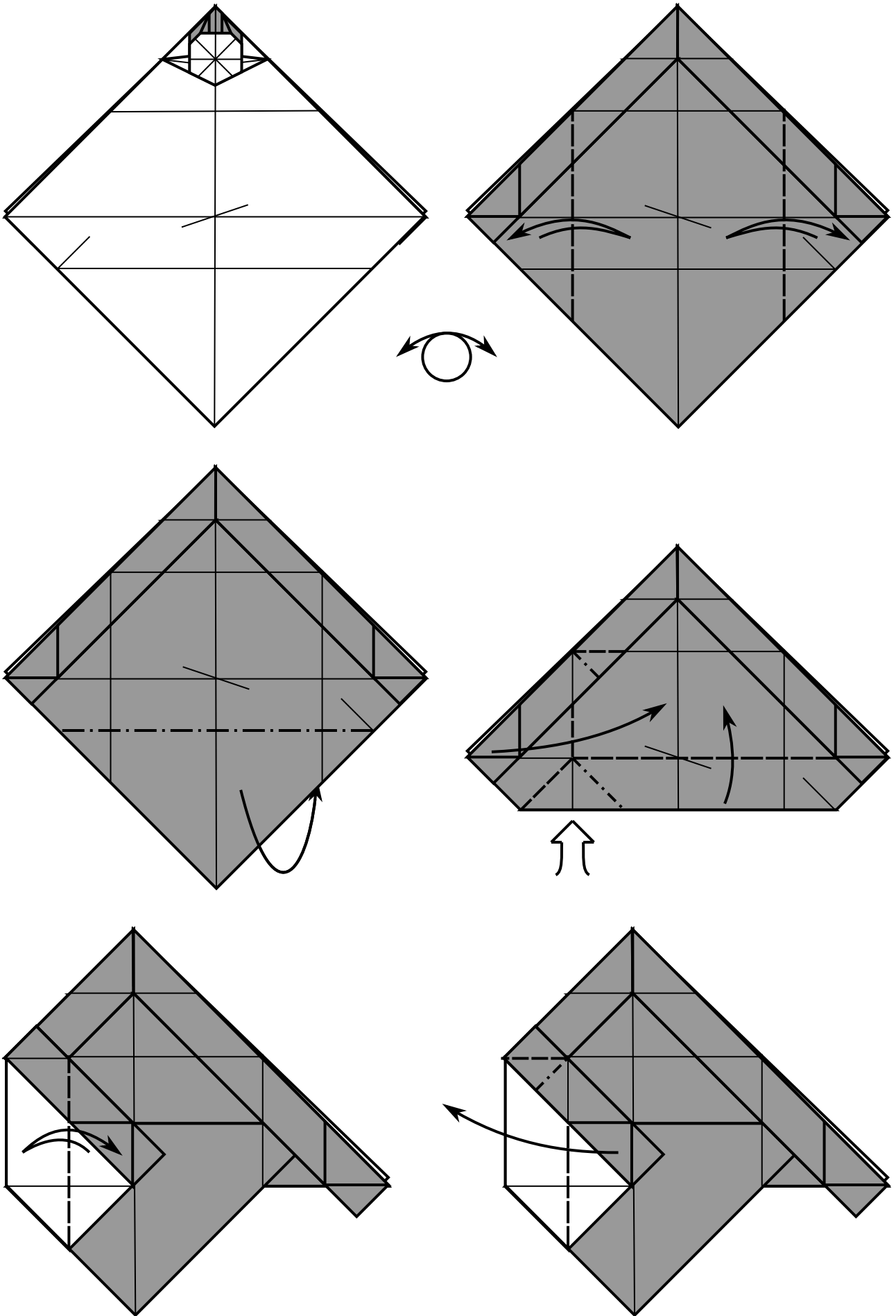

# The Bases of Folding

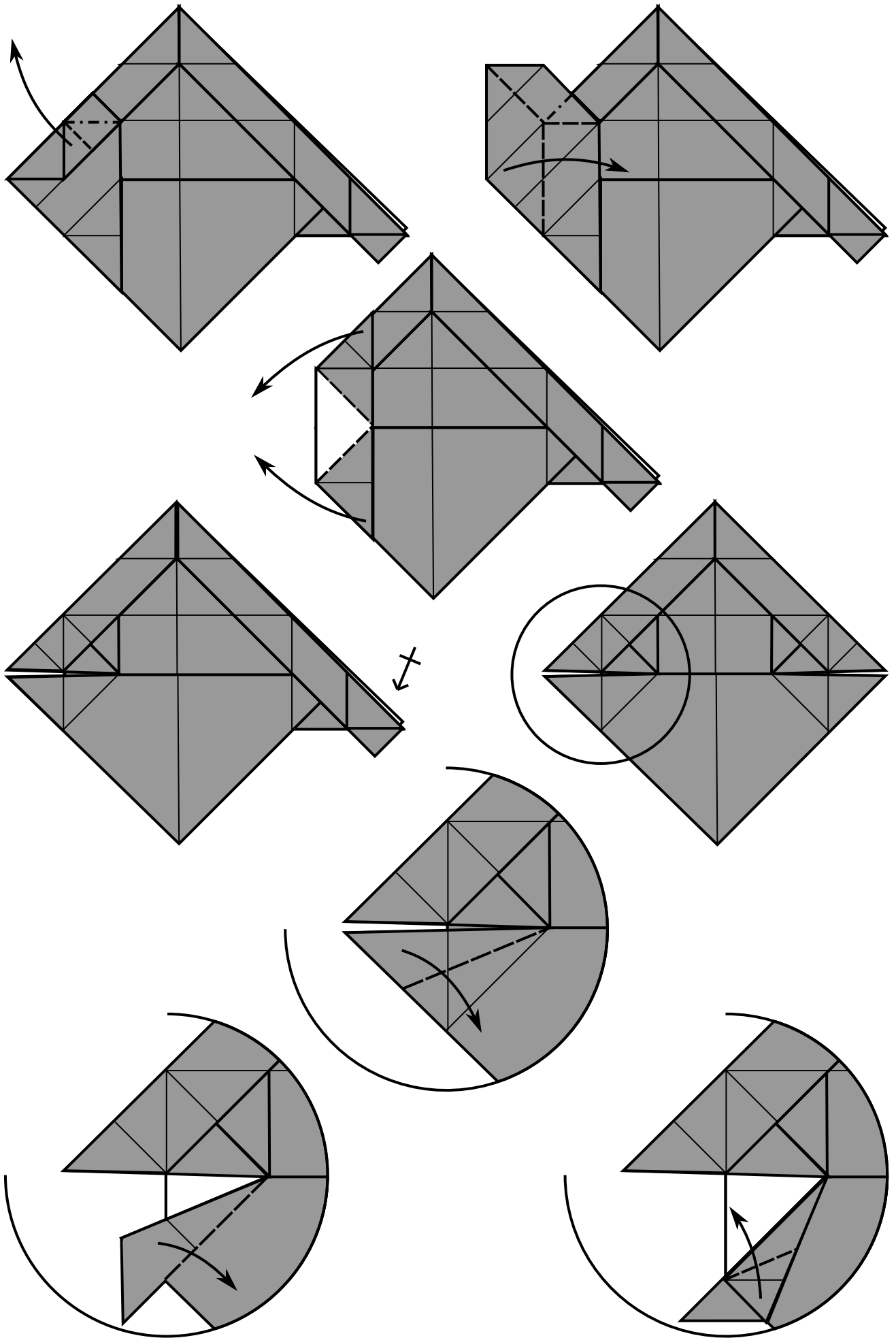

The Bases of Folding

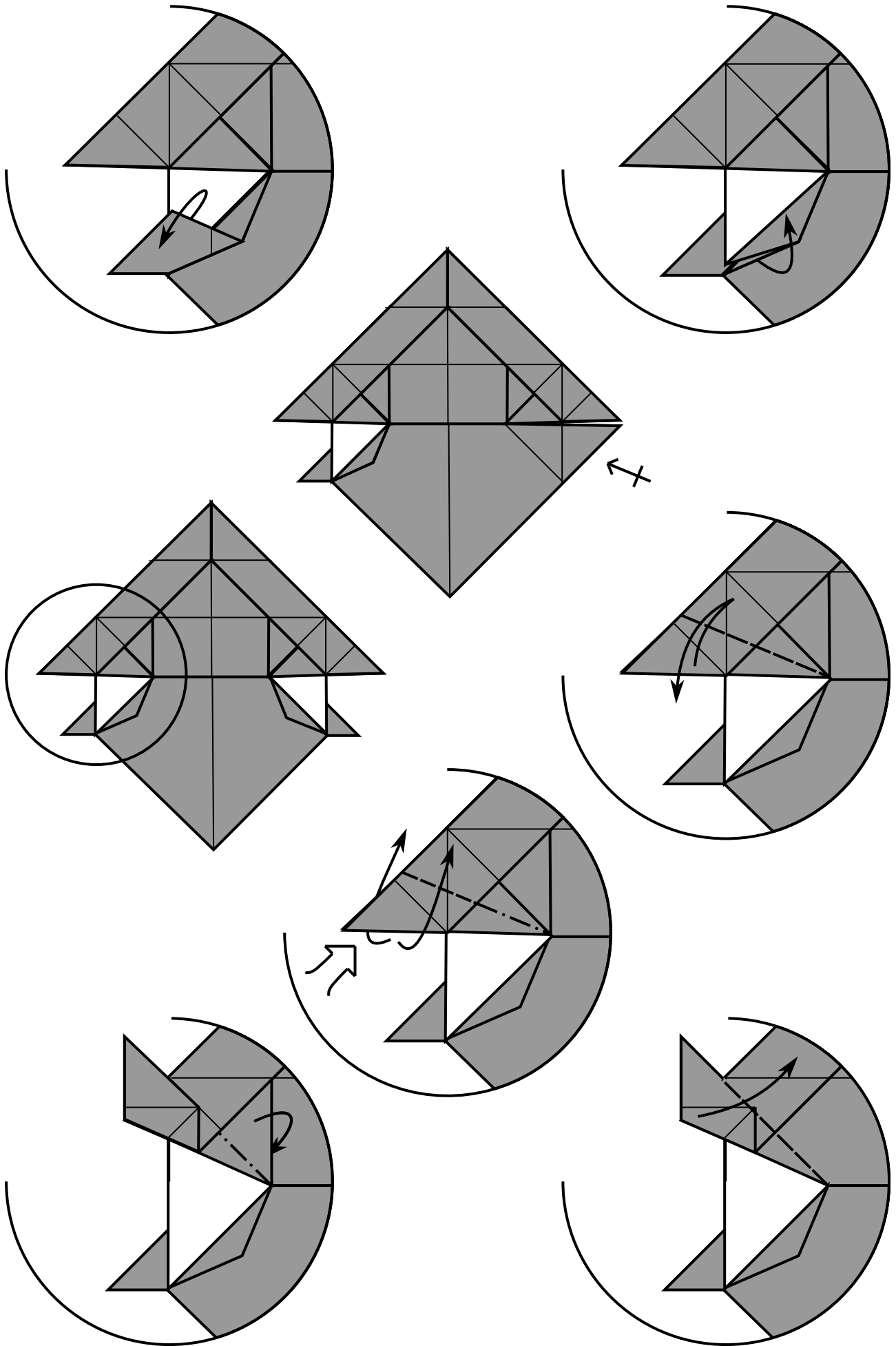

# The Bases of Folding

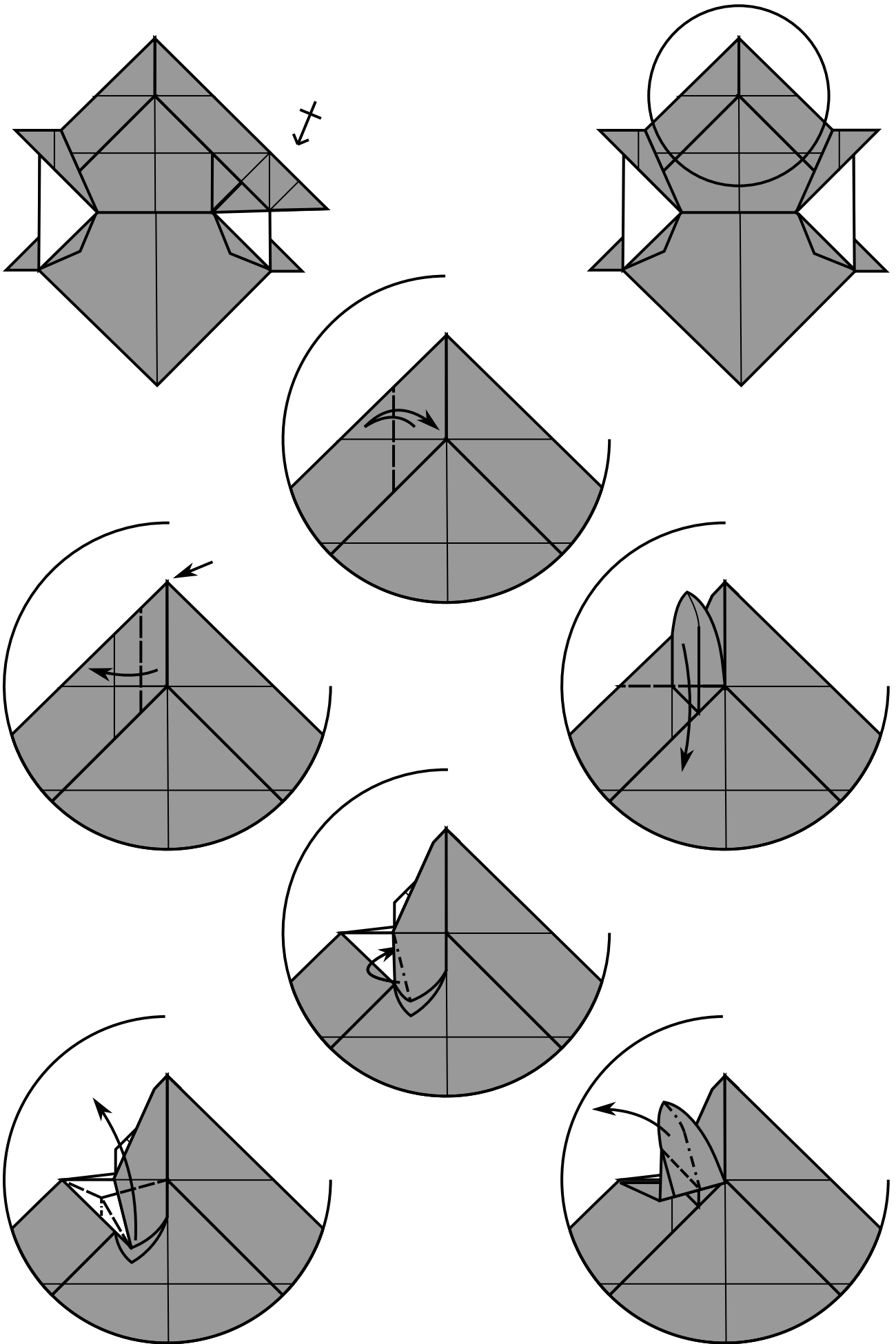

# The Bases of Folding

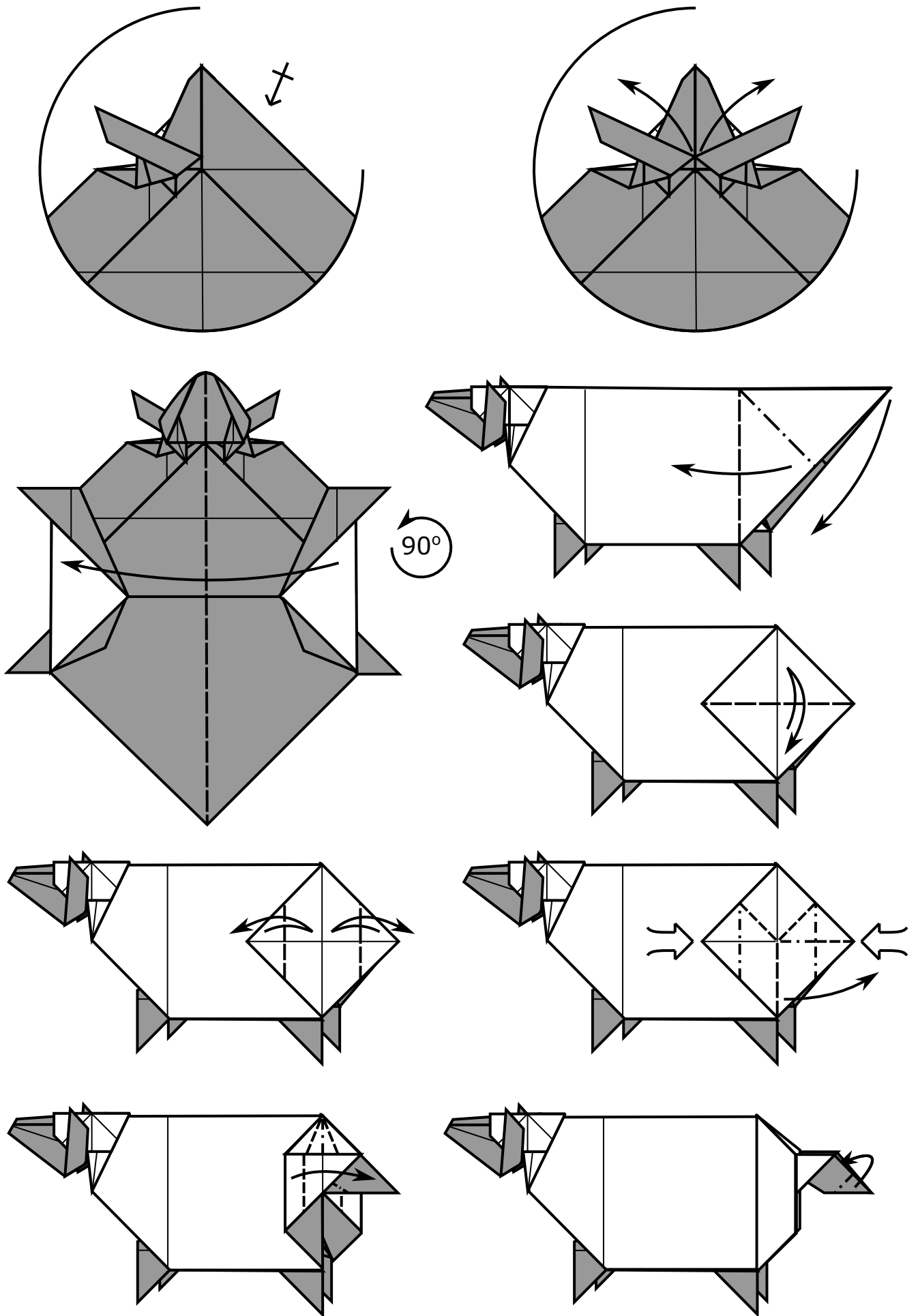

# The Bases of Folding

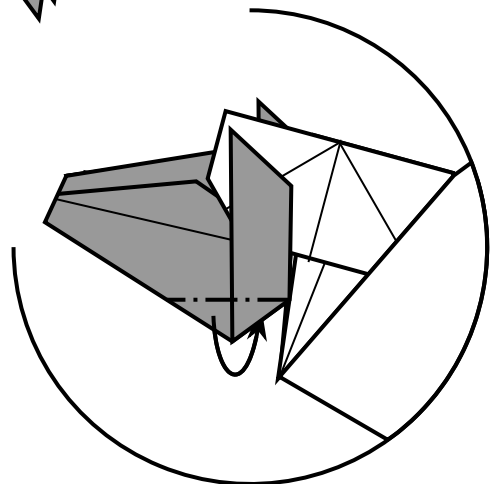
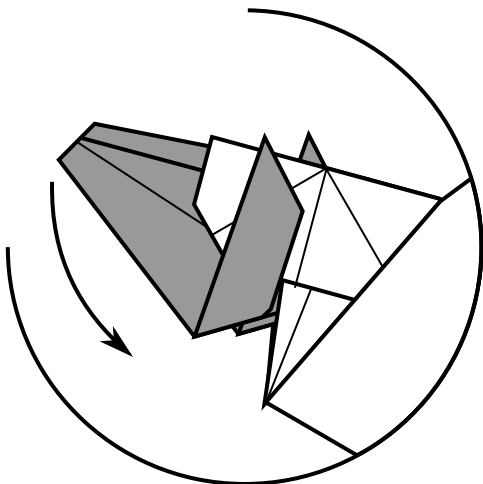
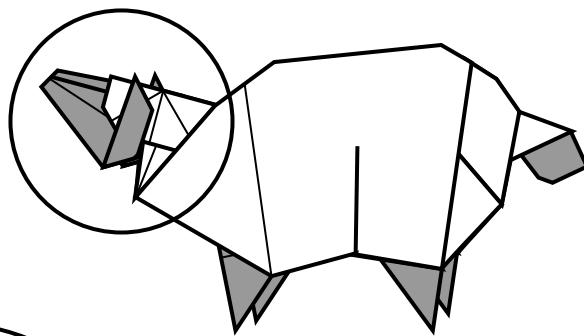
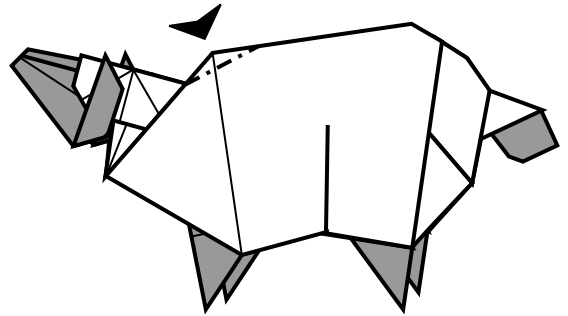
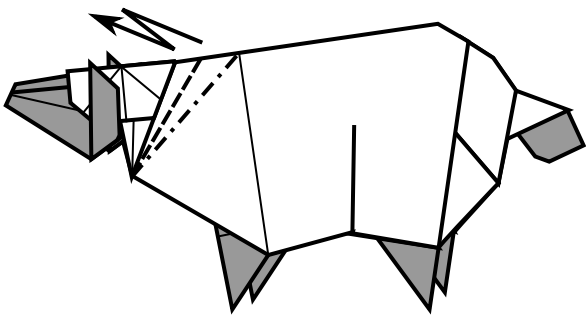
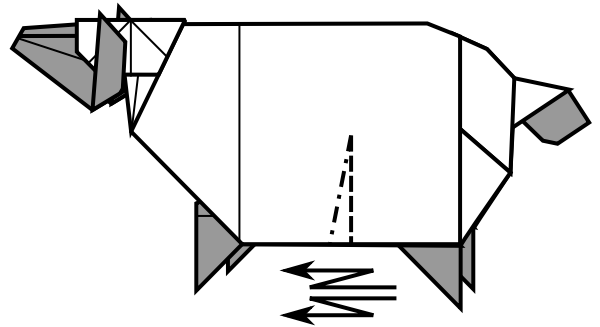
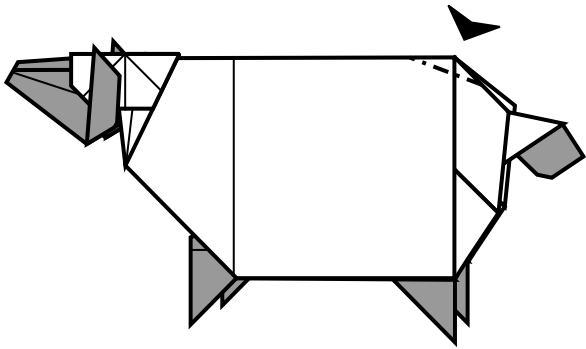
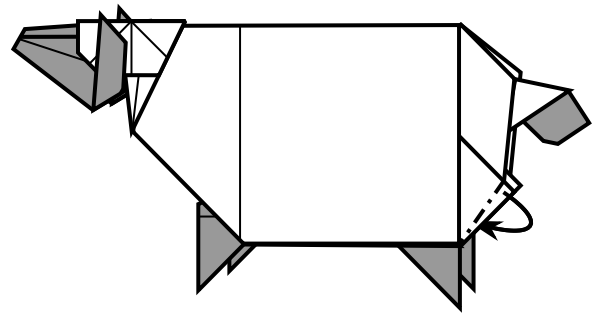
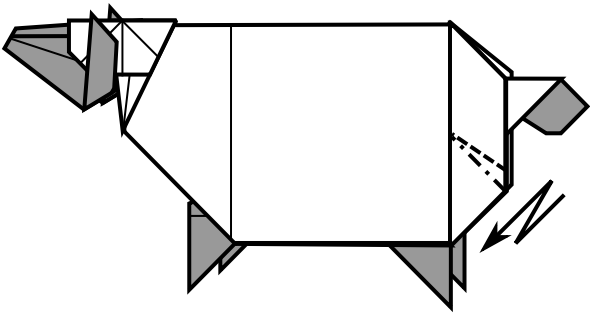

# The Bases of Folding

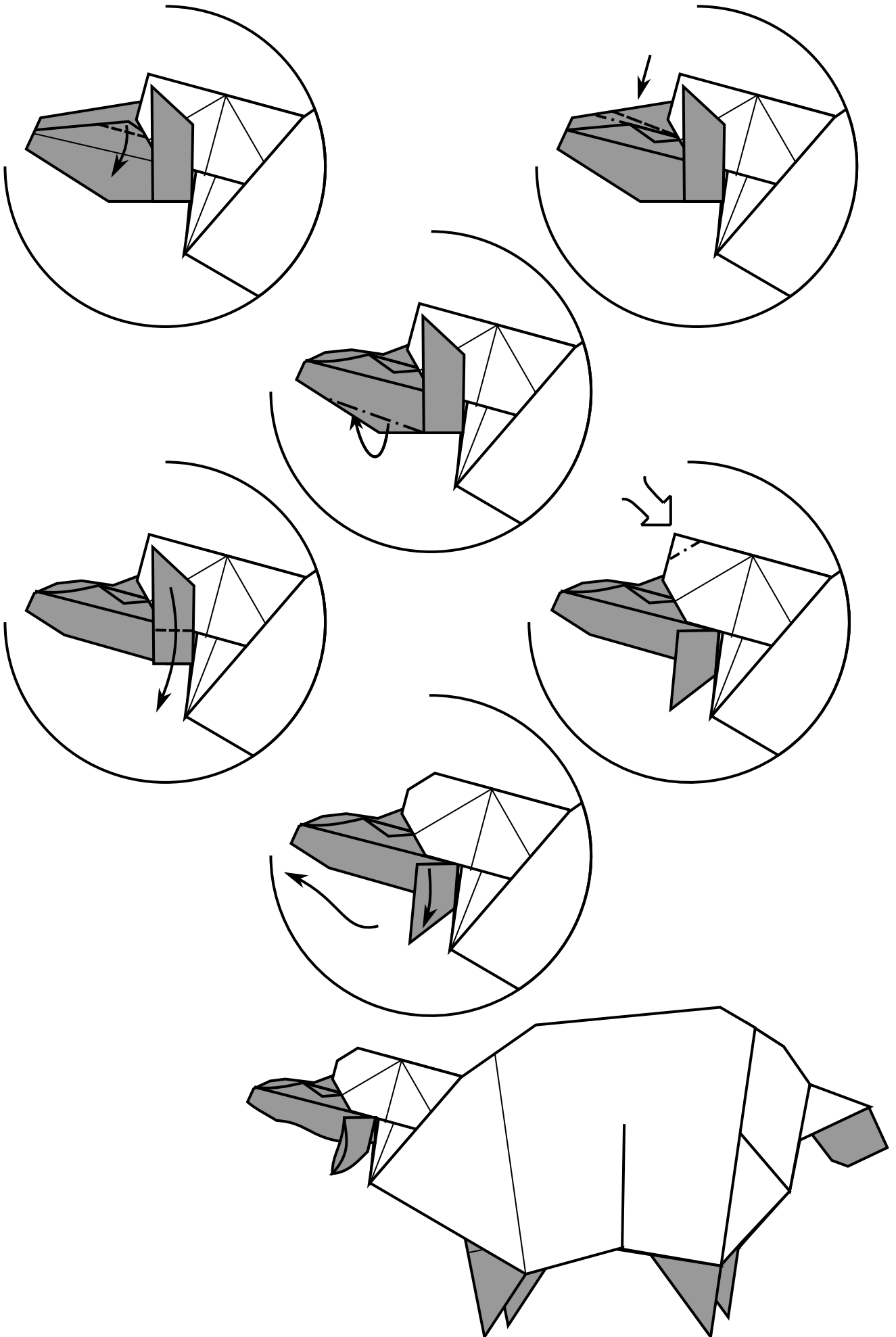



# Octopus

With the rise of social media, photo editing, filters, and dodgy camera angles have become more prevalent than ever. It may seem shallow, but anybody would want to look their best when the whole world could be watching.

This model is actually pretty simple (and mediocre). But if you fold everything *just* right, and make sure to photograph its good side, the result looks rather impressive.

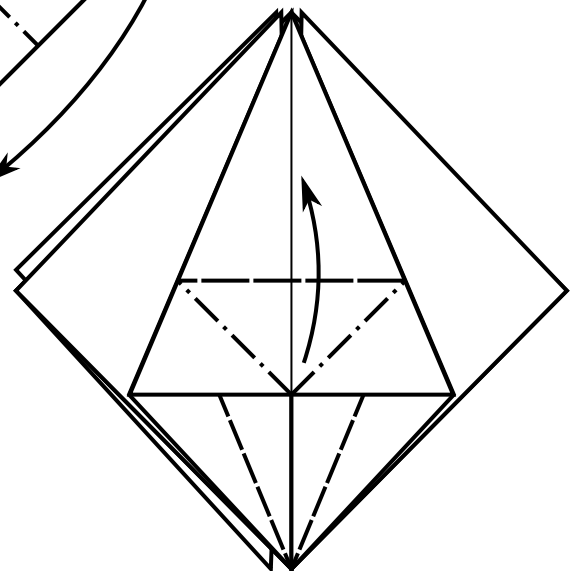
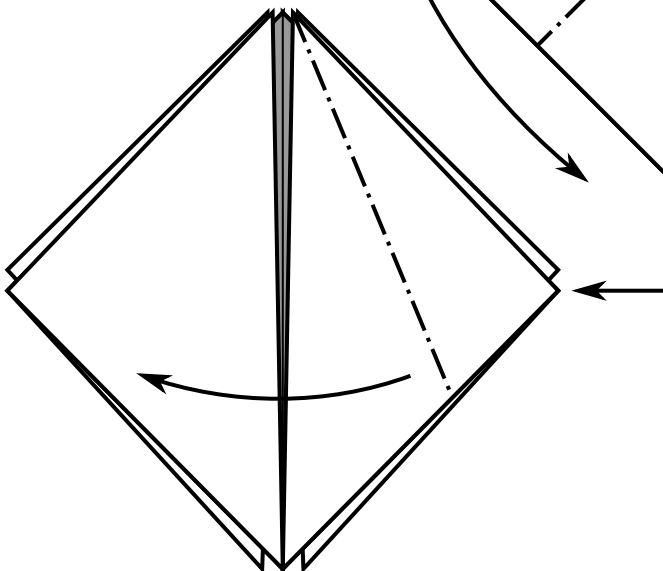
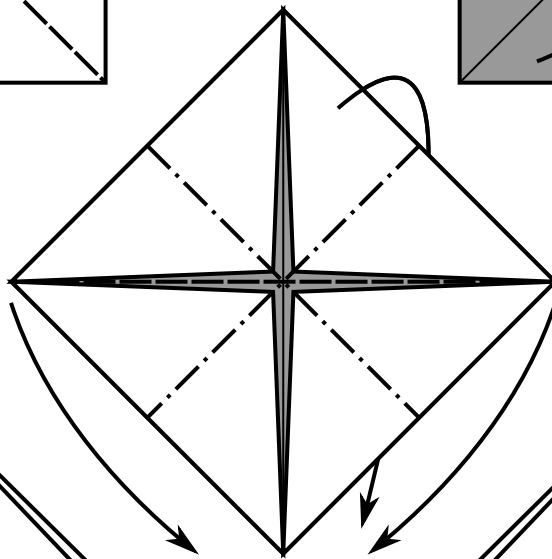
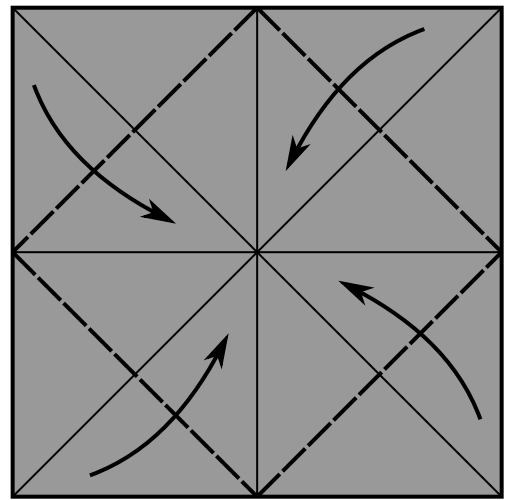
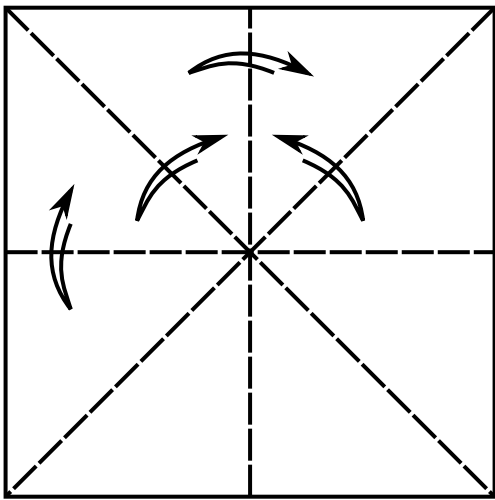

The Bases of Folding

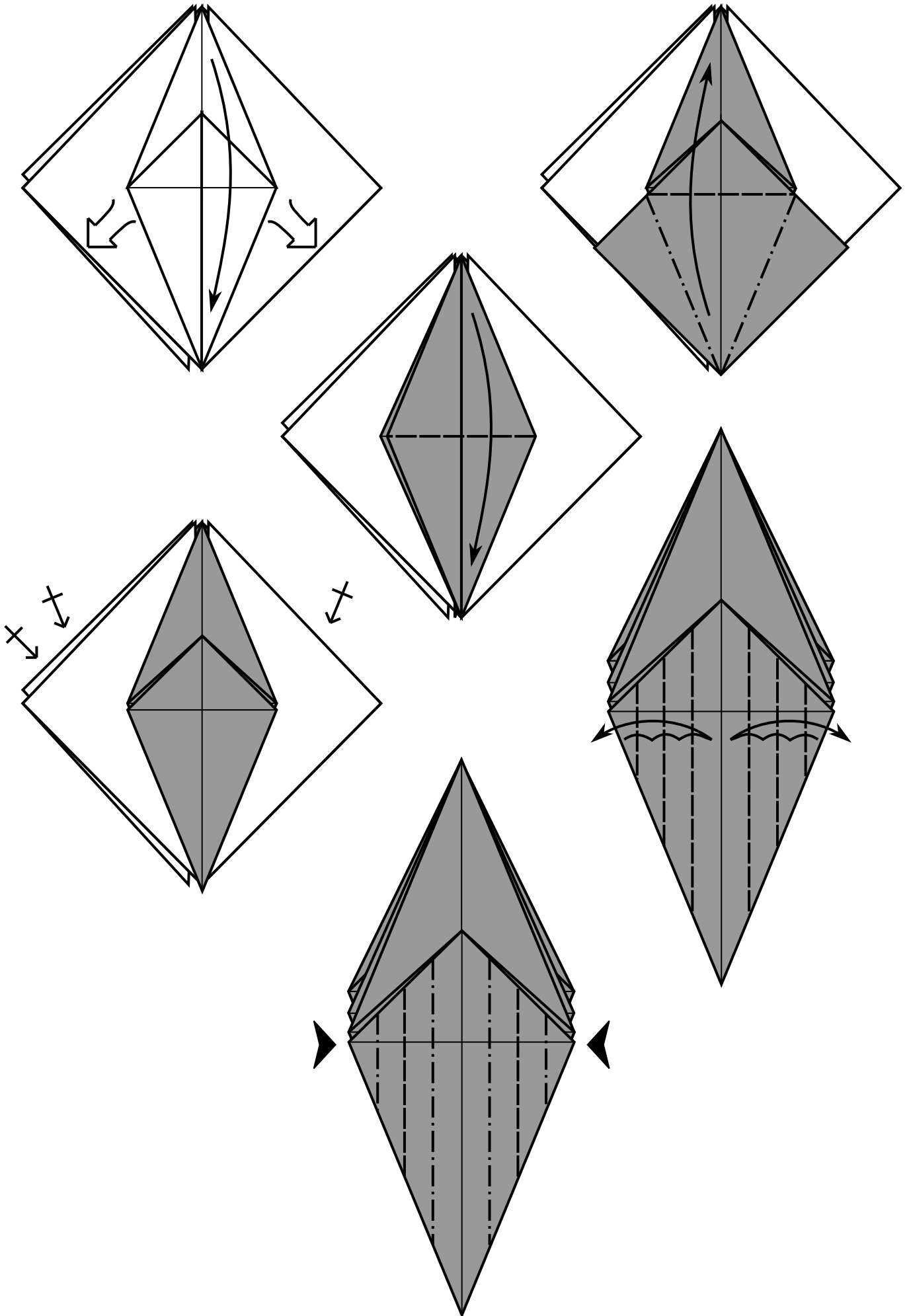

The Bases of Folding

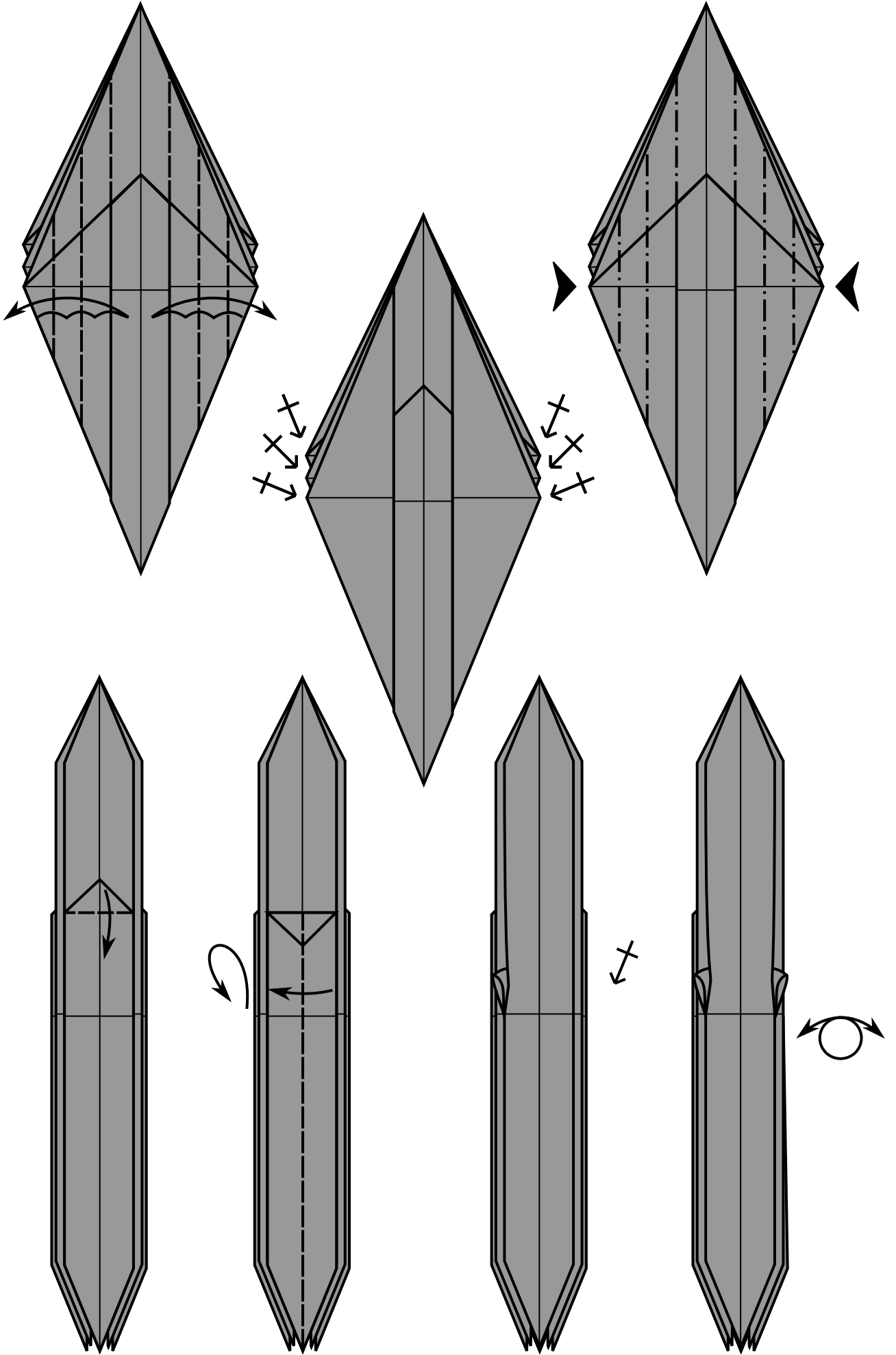

The Bases of Folding

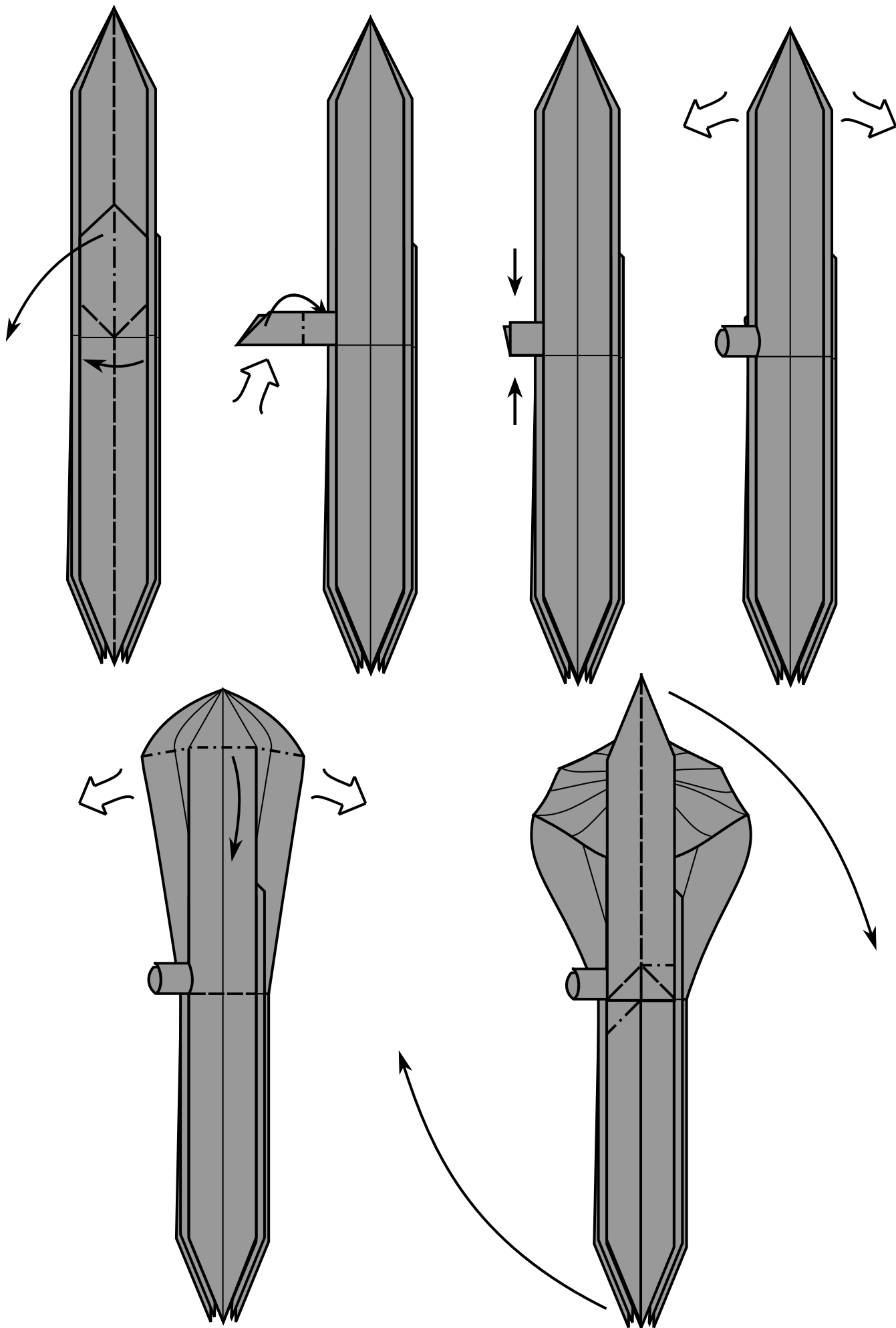

# The Bases of Folding

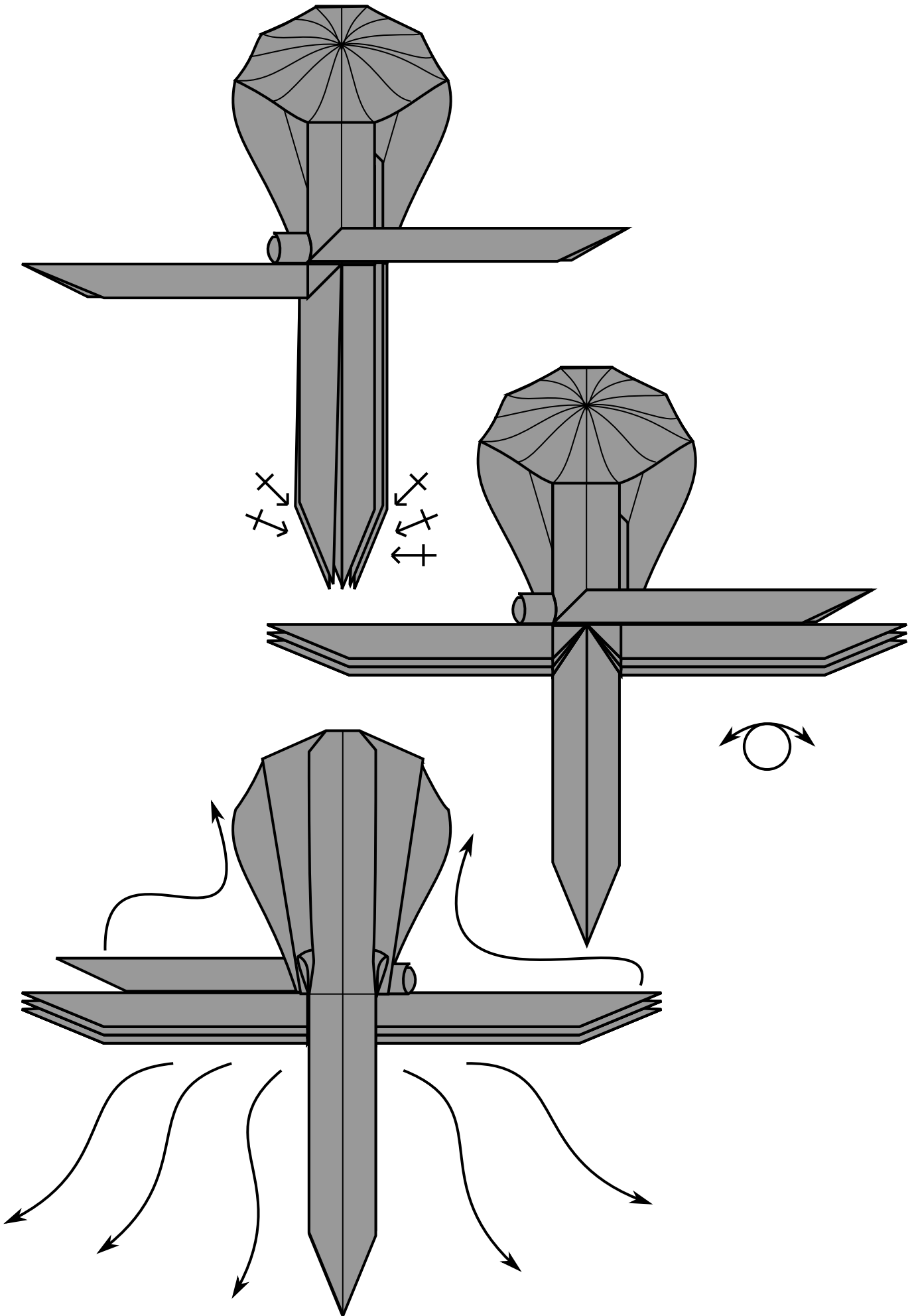

# The Bases of Folding

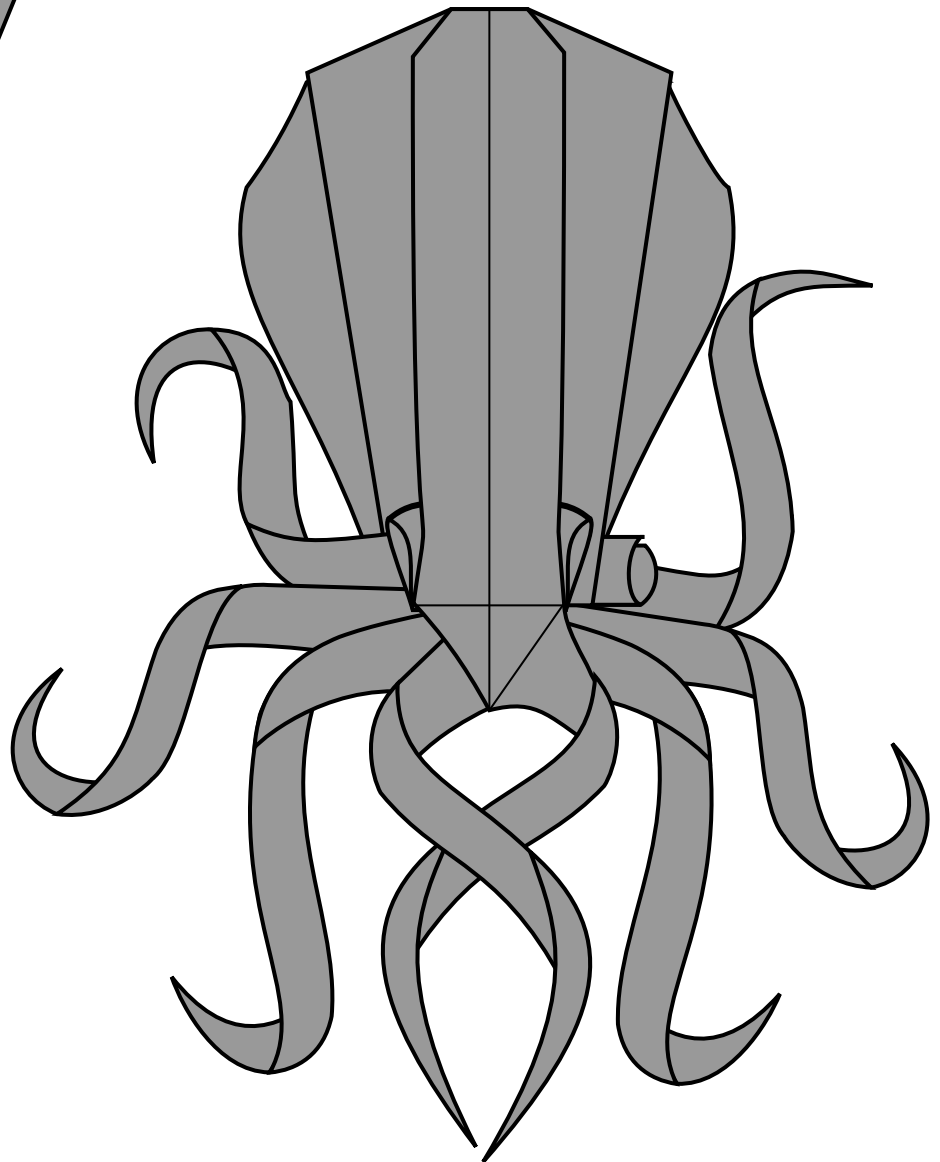
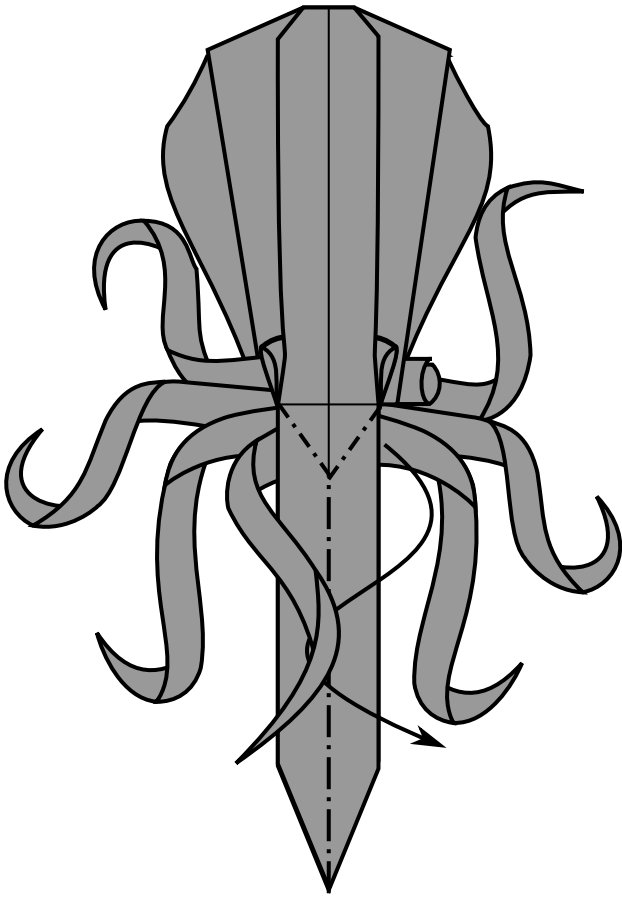

# Lion

Sometimes, all it takes to make a hit song is a great hook. And all it takes to make a memorable movie is one impactful line. We often judge a work by its best (or worst) parts, and not its entirety.

I started this model with one thing in mind: the shape of the nose and mouth. What I settled on naturally lent itself to the rest of the design.

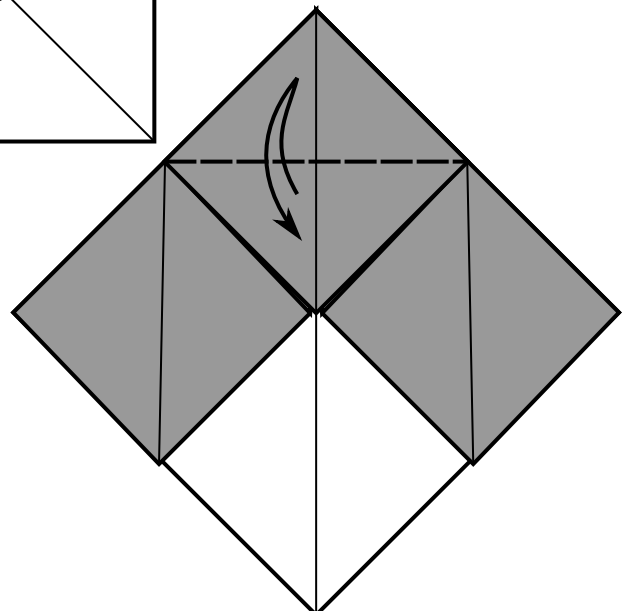
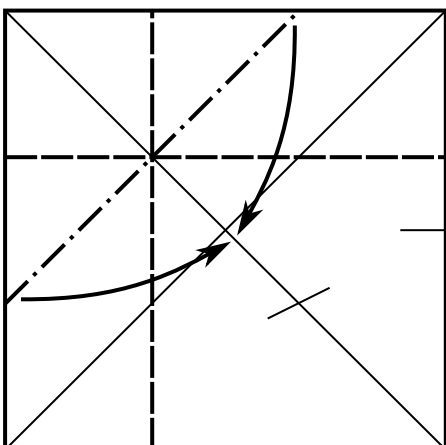
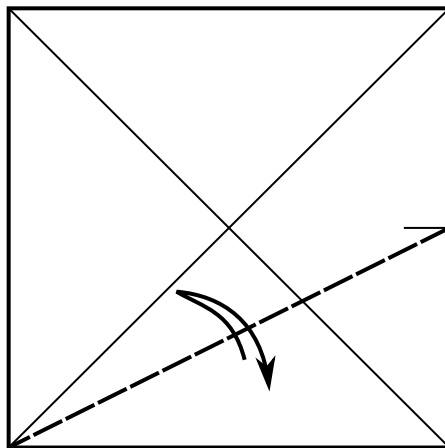
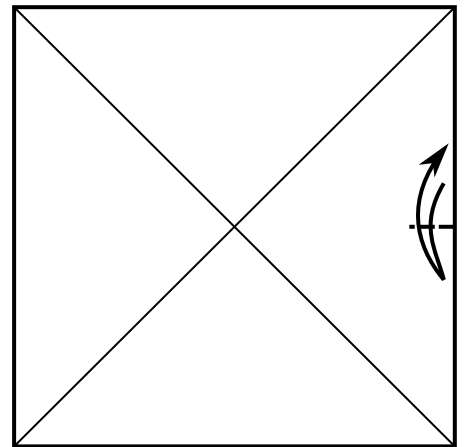
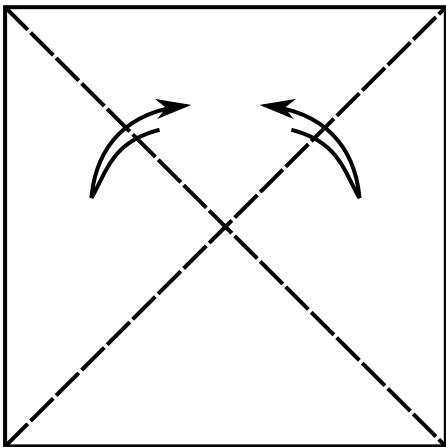

The Bases of Folding

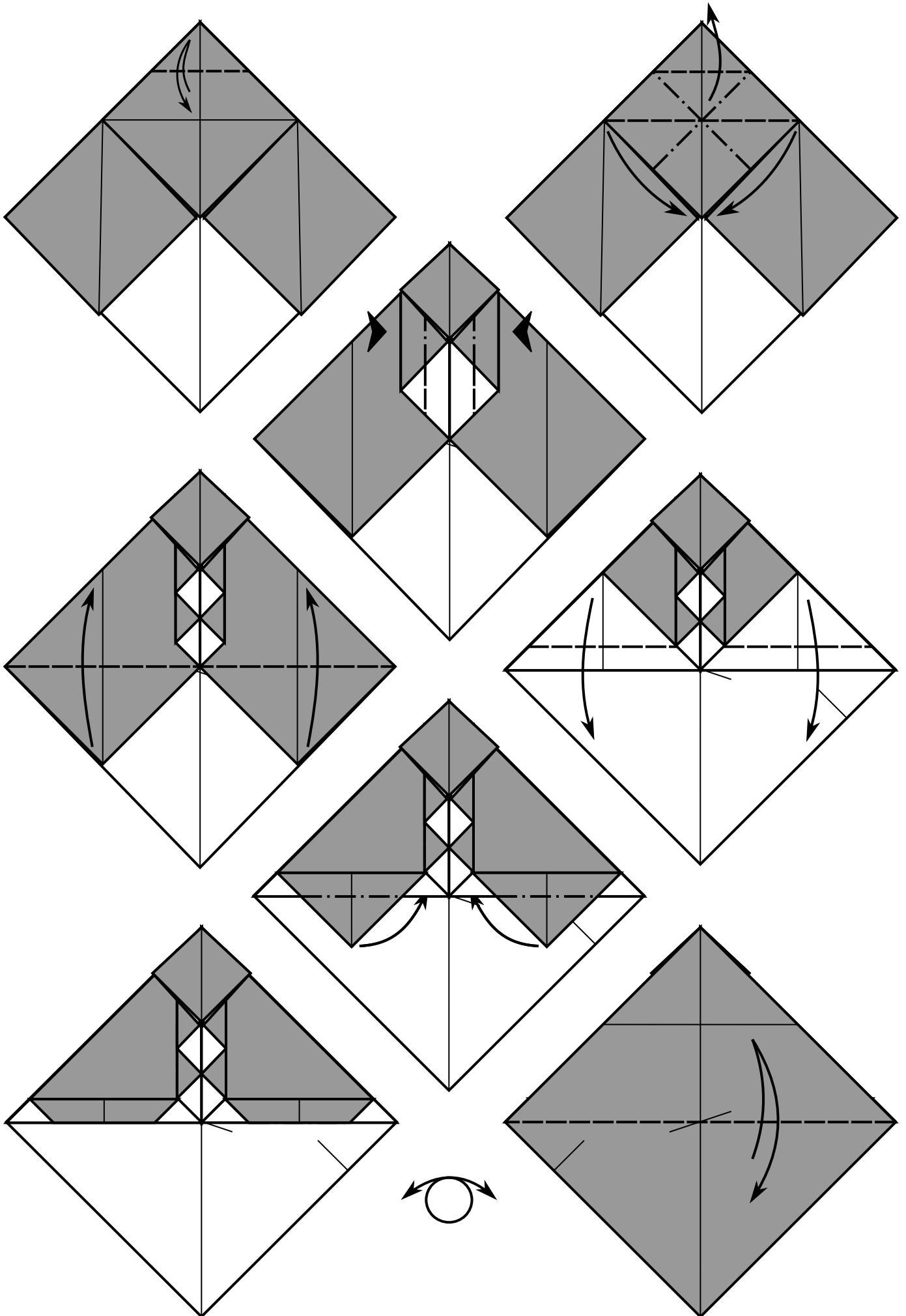



# The Bases of Folding

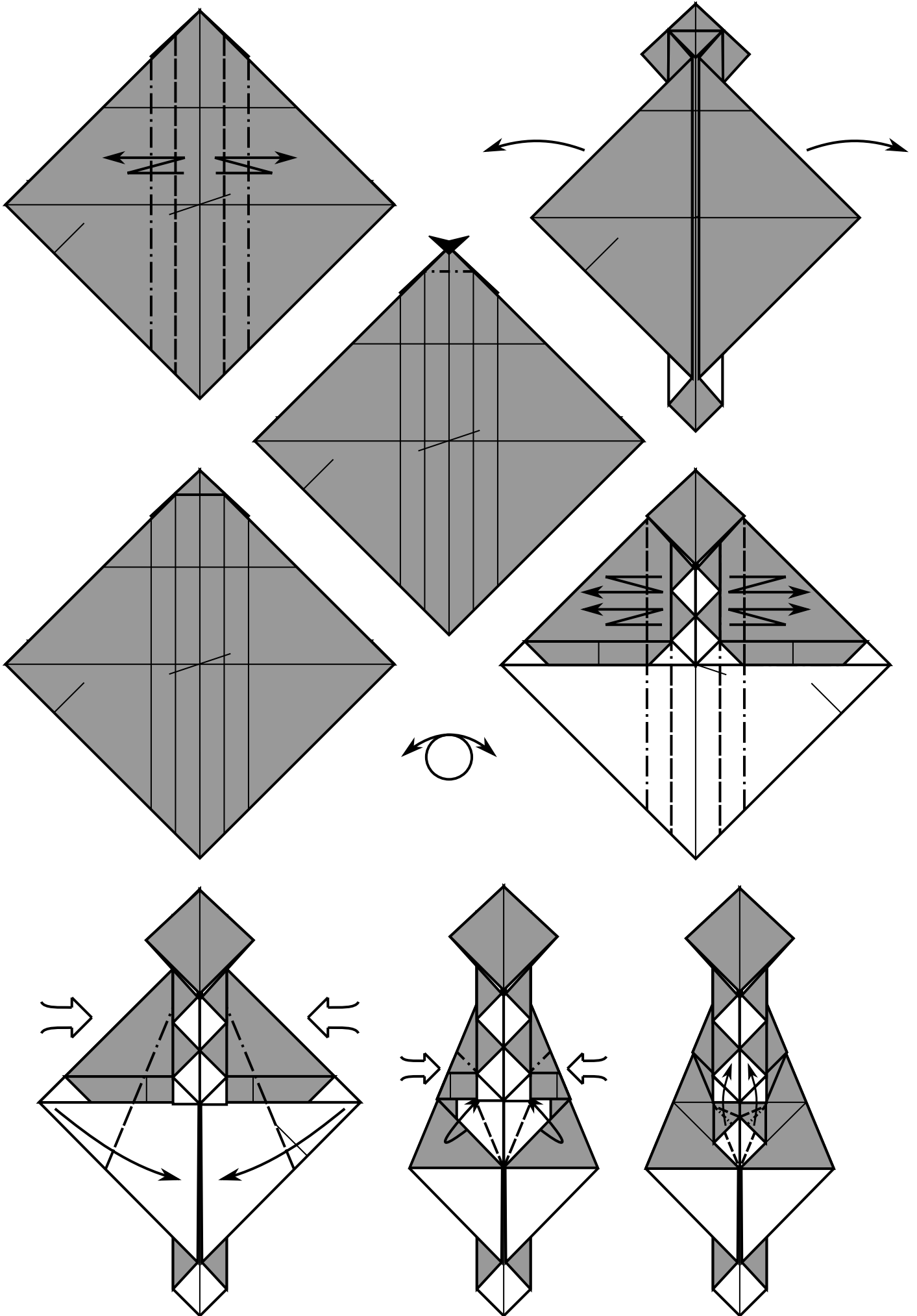

The Bases of Folding

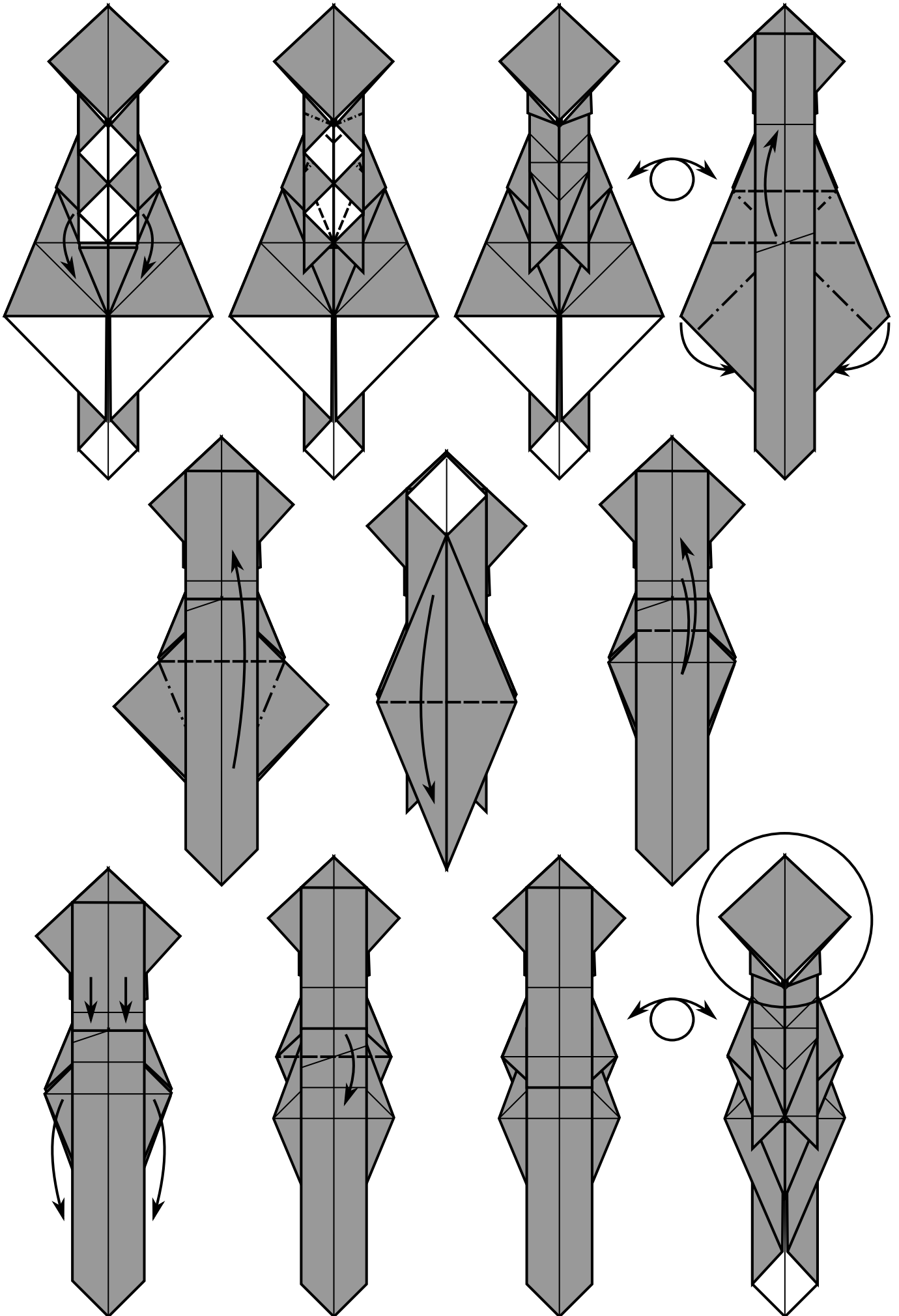

The Bases of Folding

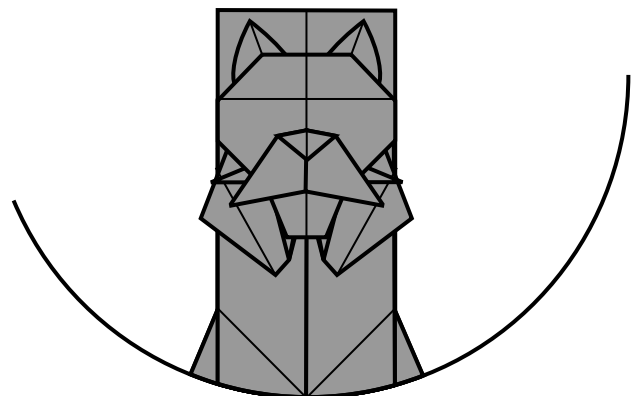
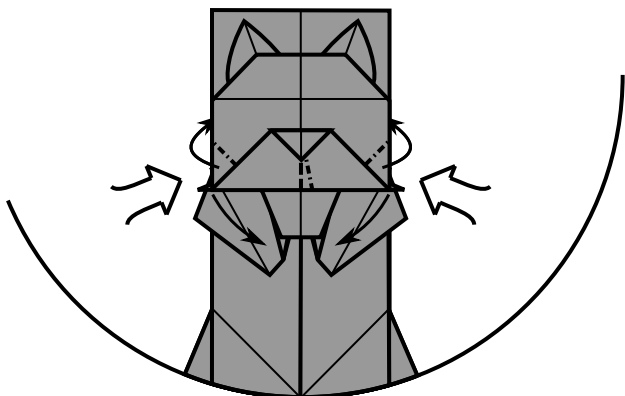
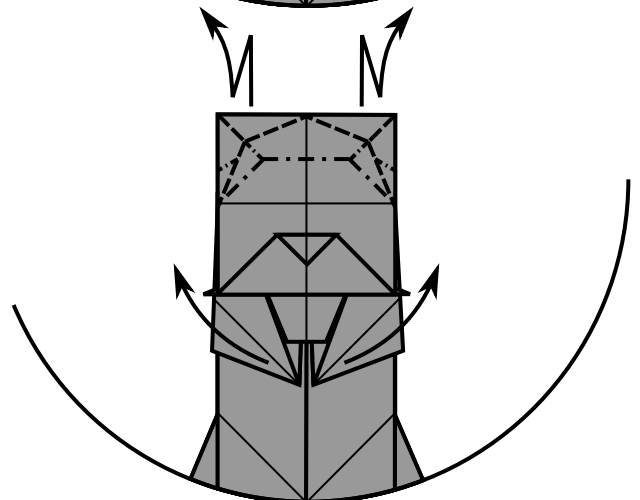
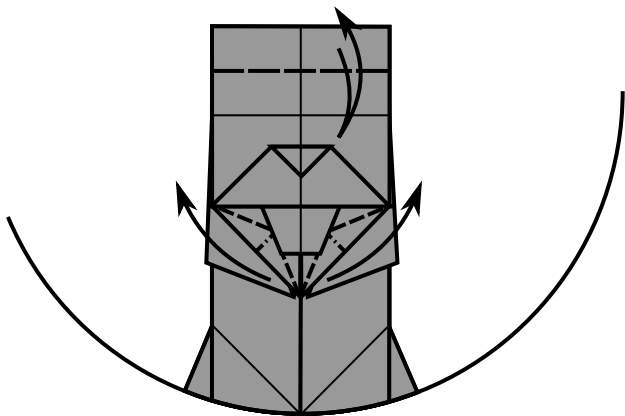
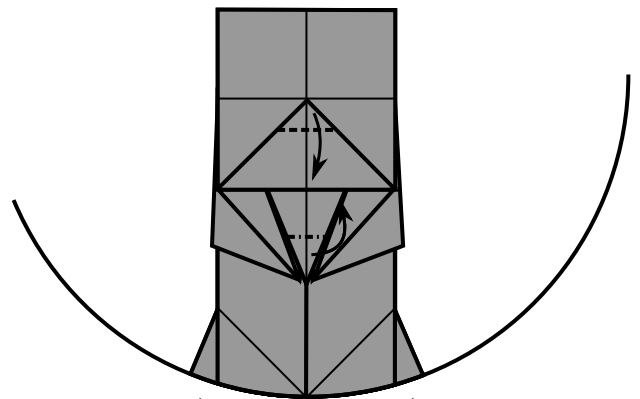
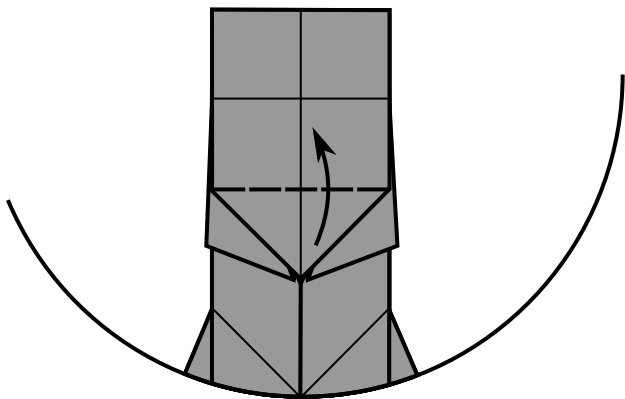
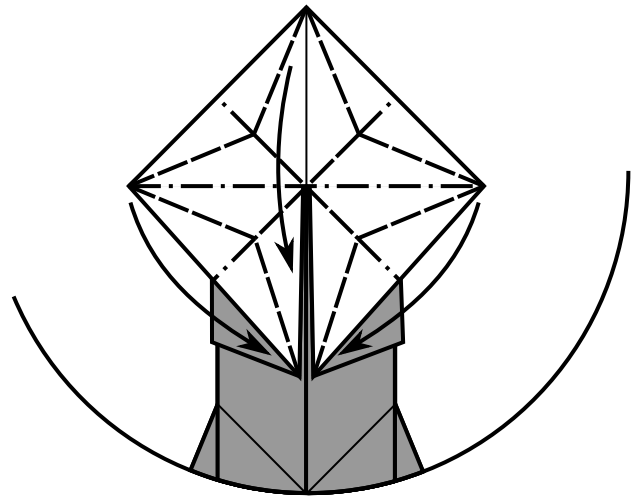
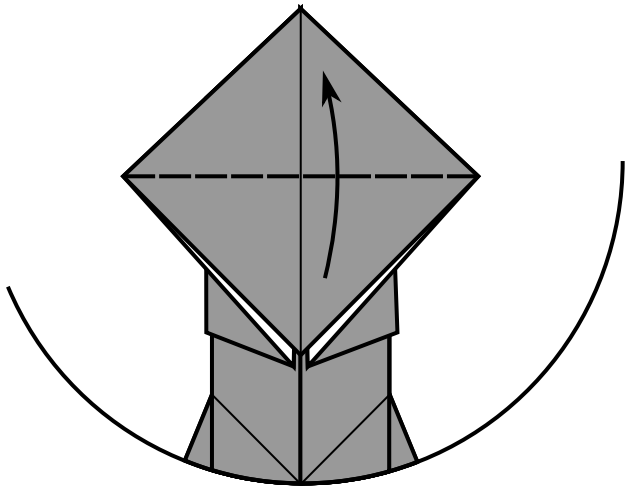

# The Bases of Folding

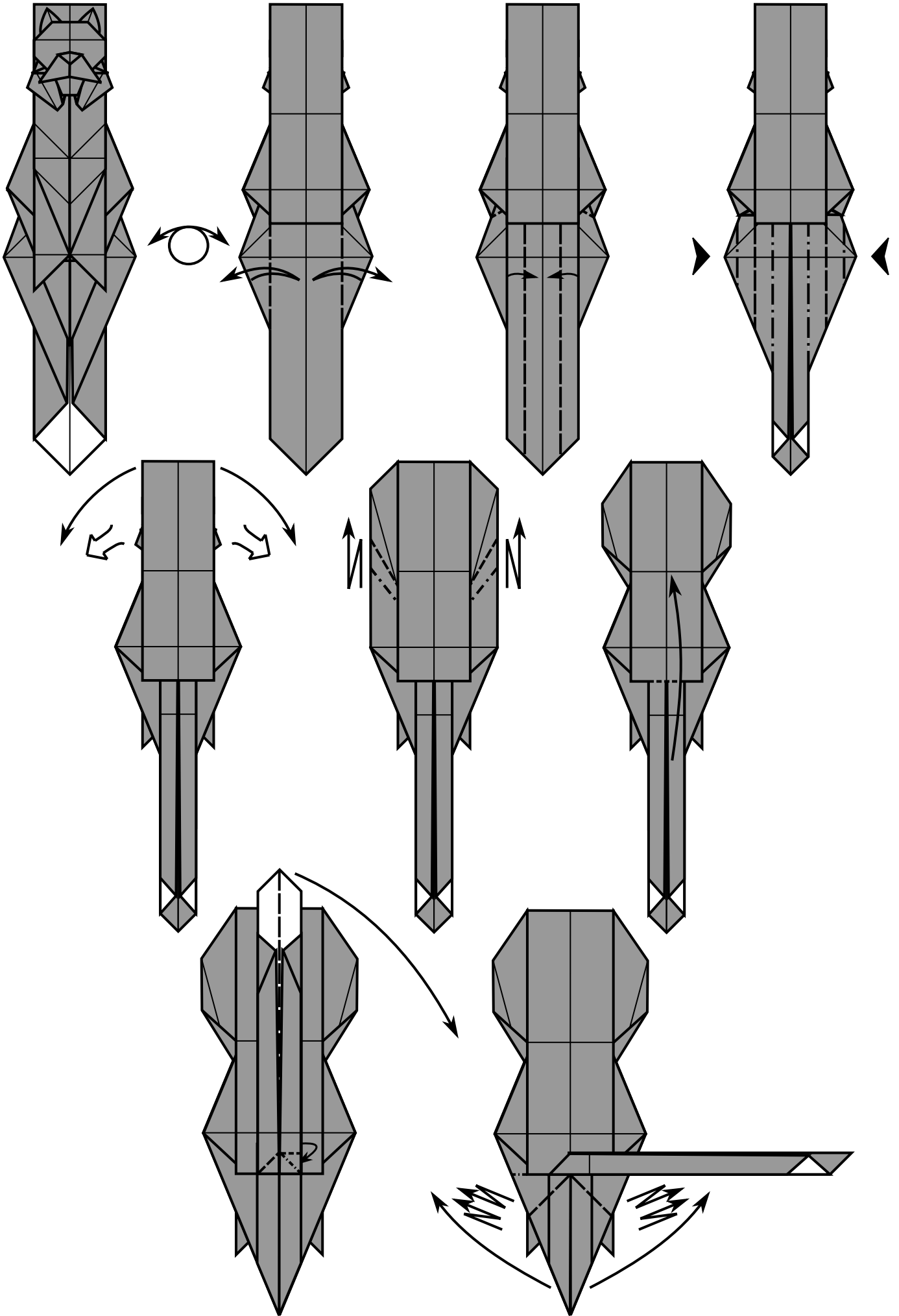

The Bases of Folding

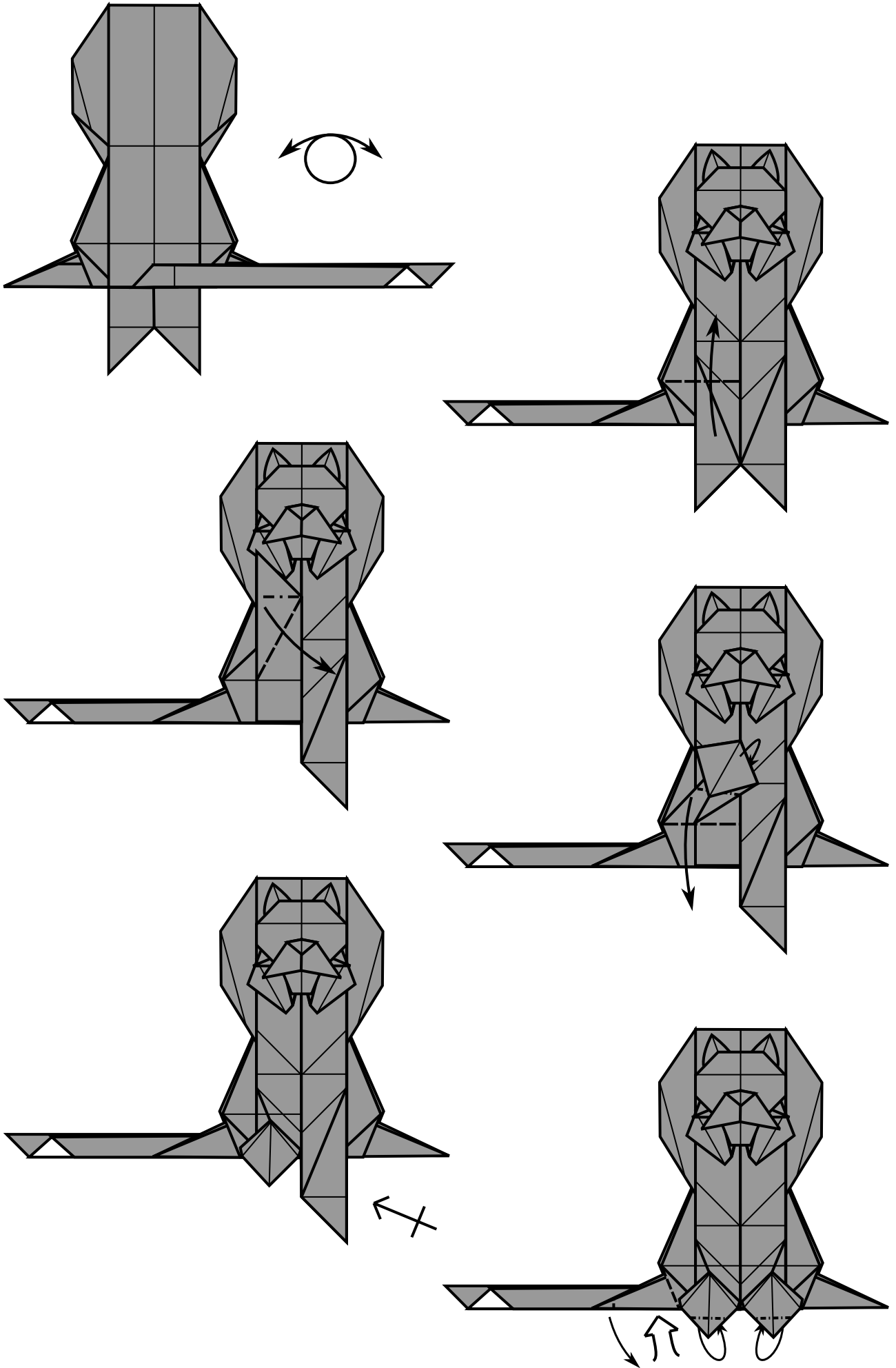

# The Bases of Folding

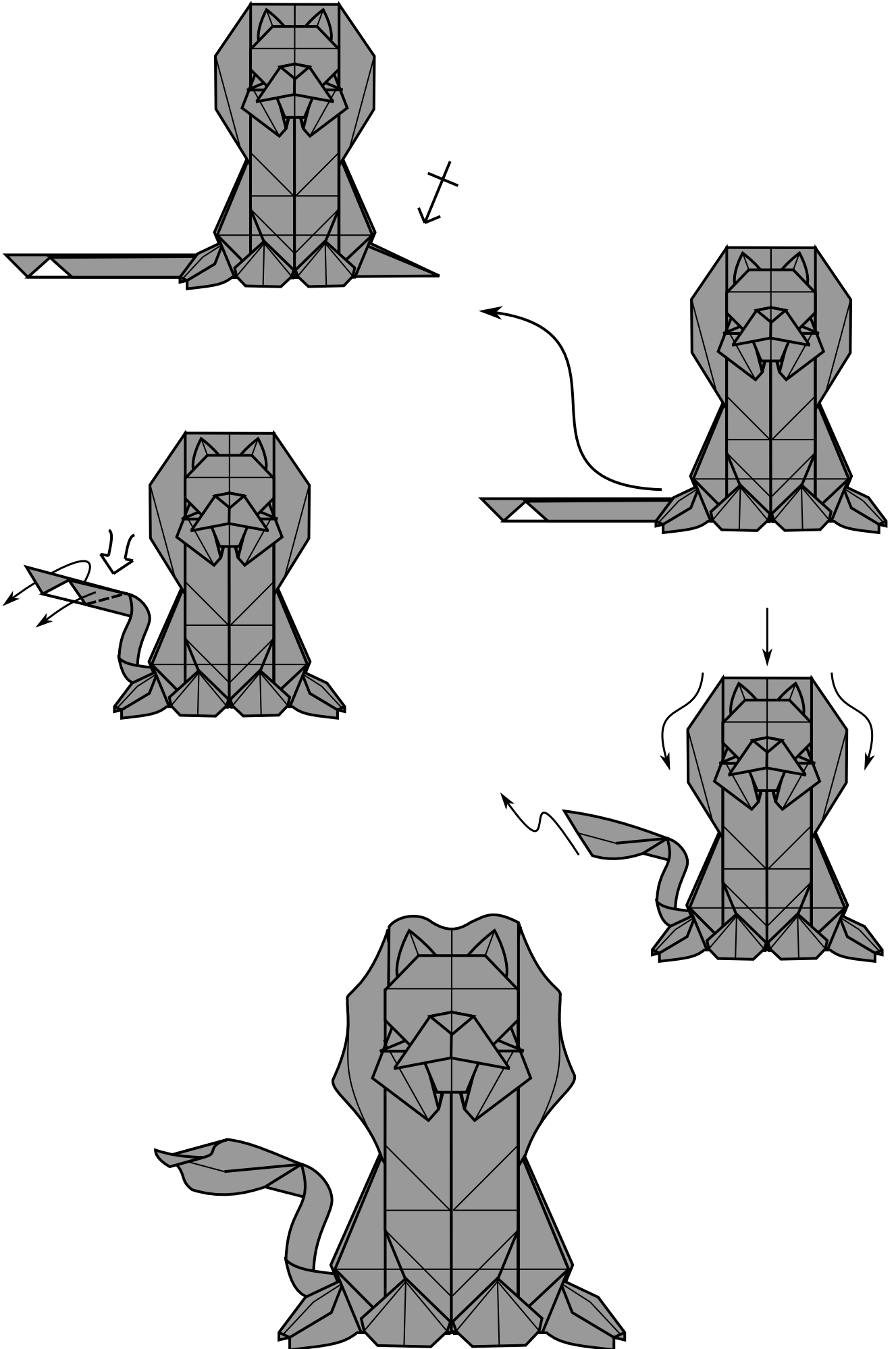

# Wolf

A butterfly flaps its wings in Japan, and a week later I get drenched in the United States. These small changes can build up over time, leading to massive, world shattering events. Or maybe I just need to buy a bug net.

This model follows the lion diagram until page 103, but a few alterations dramatically reshape the head, shoulders, and tail, creating something new.

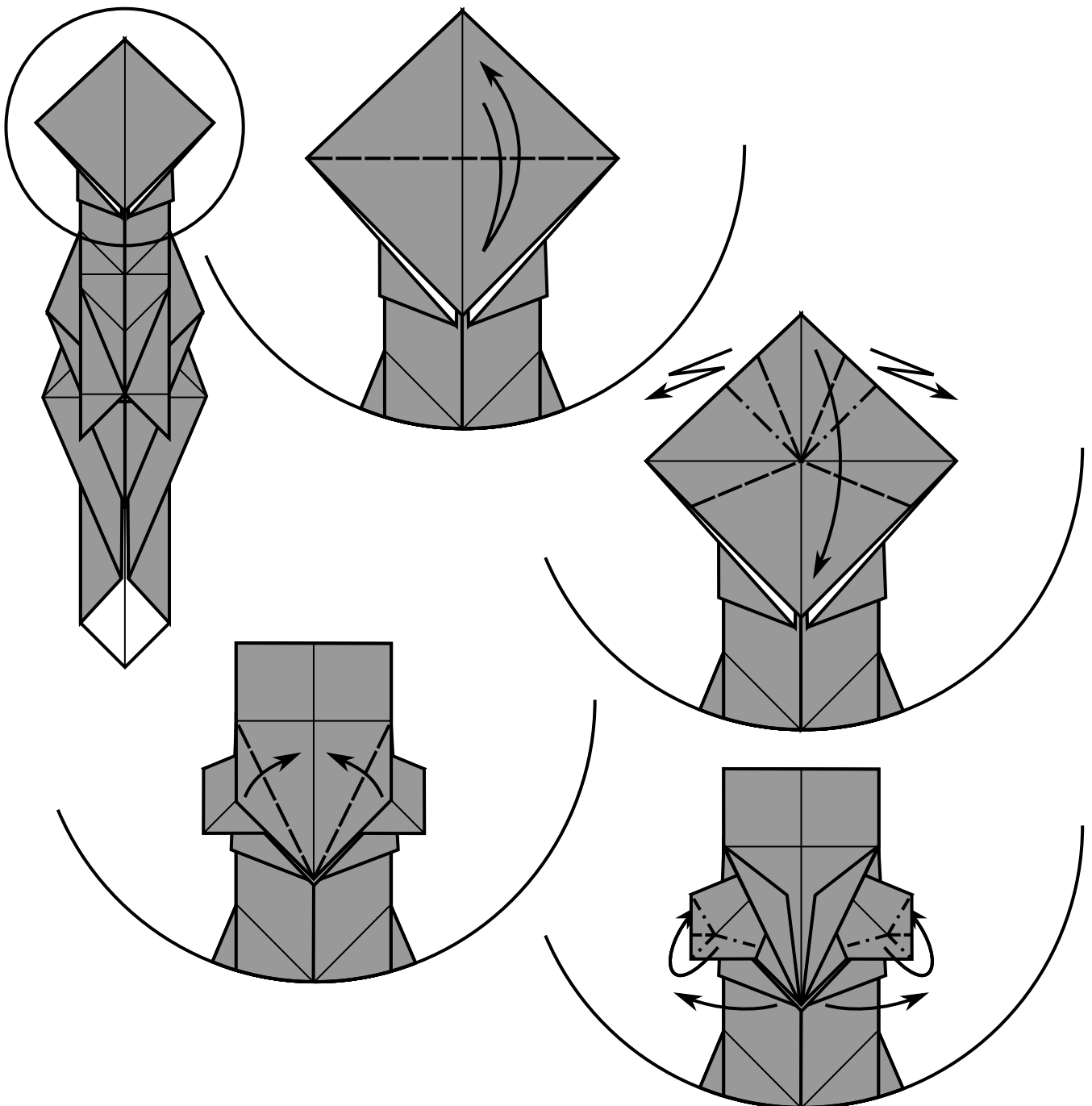

# The Bases of Folding

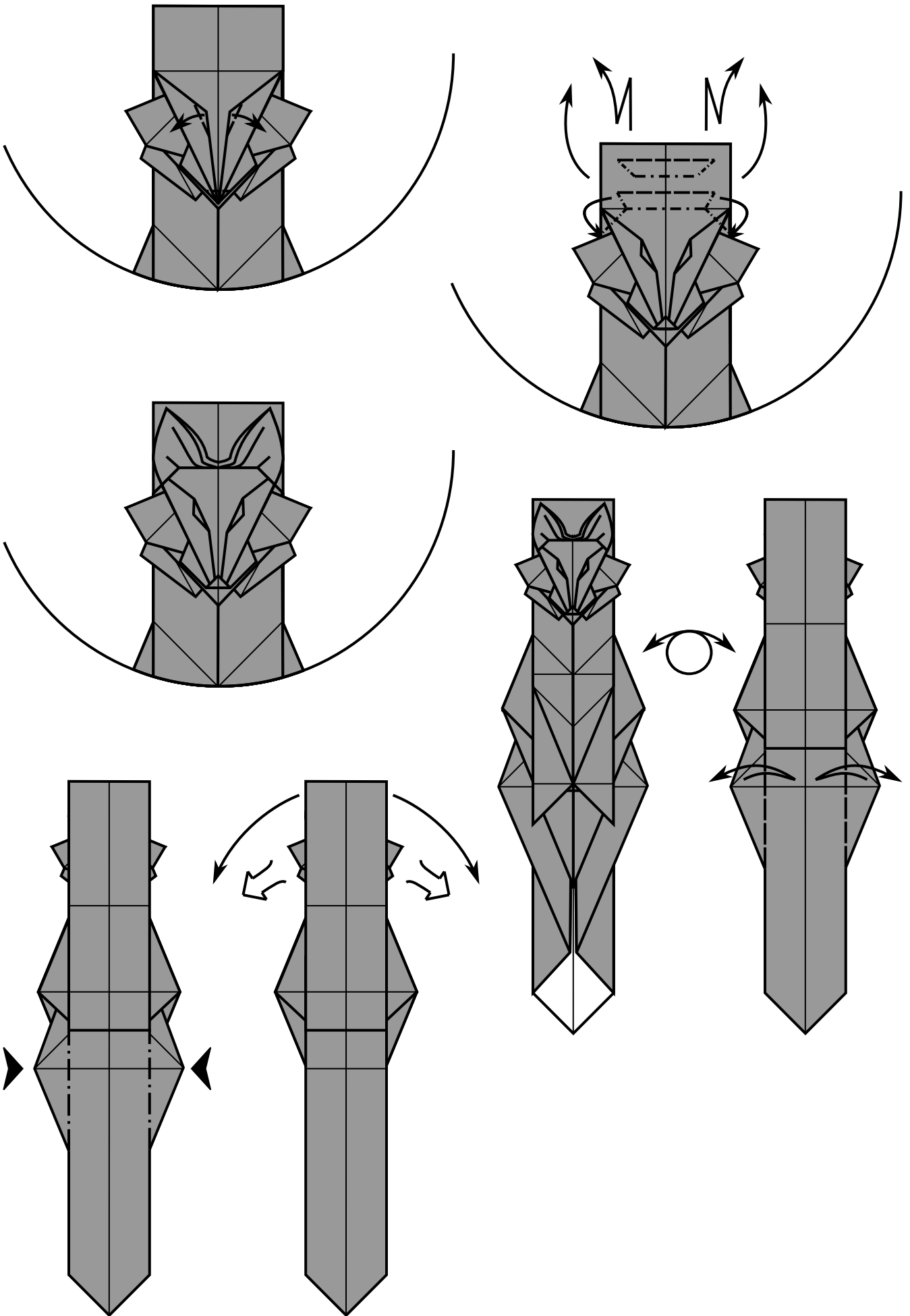



# The Bases of Folding

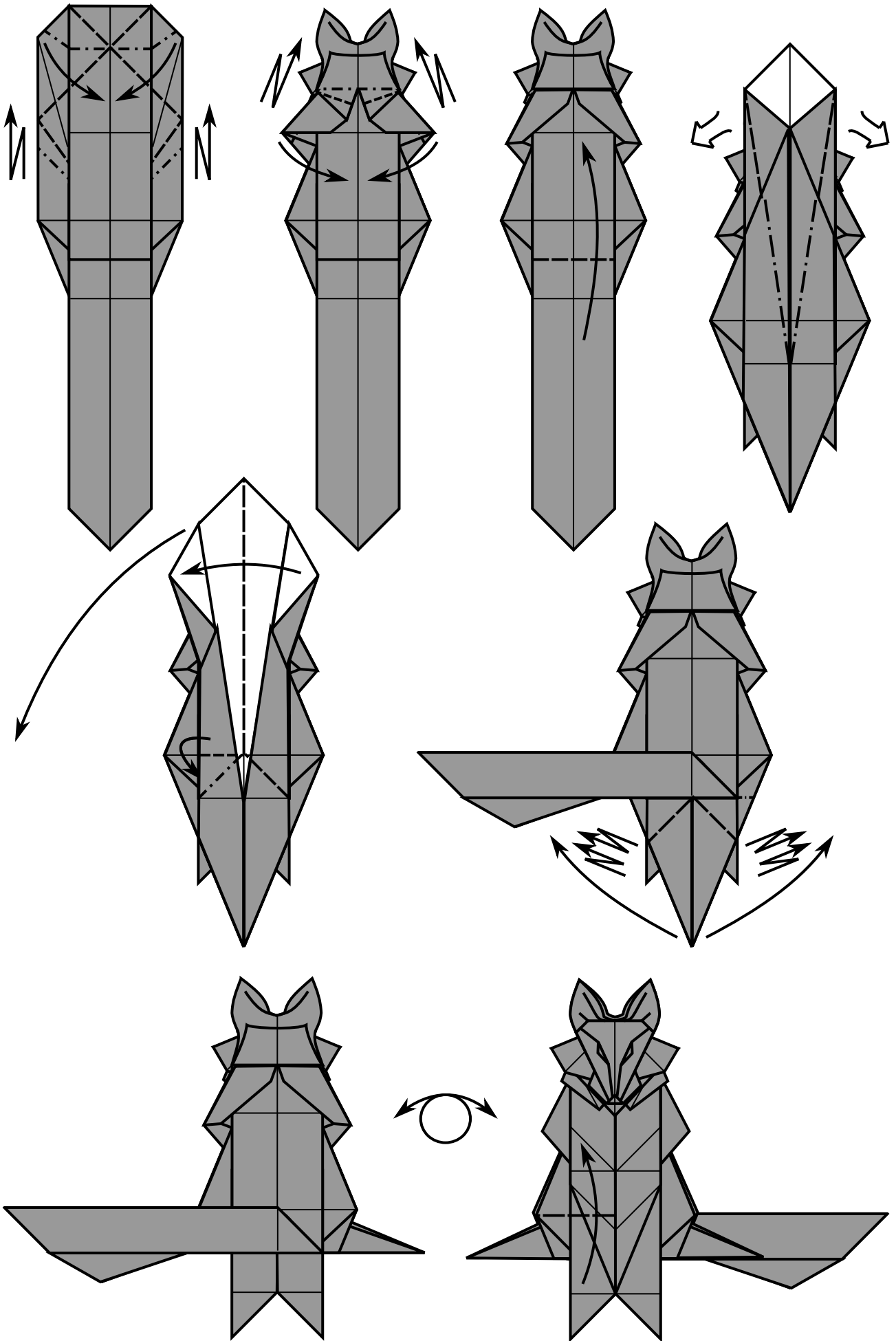

The Bases of Folding

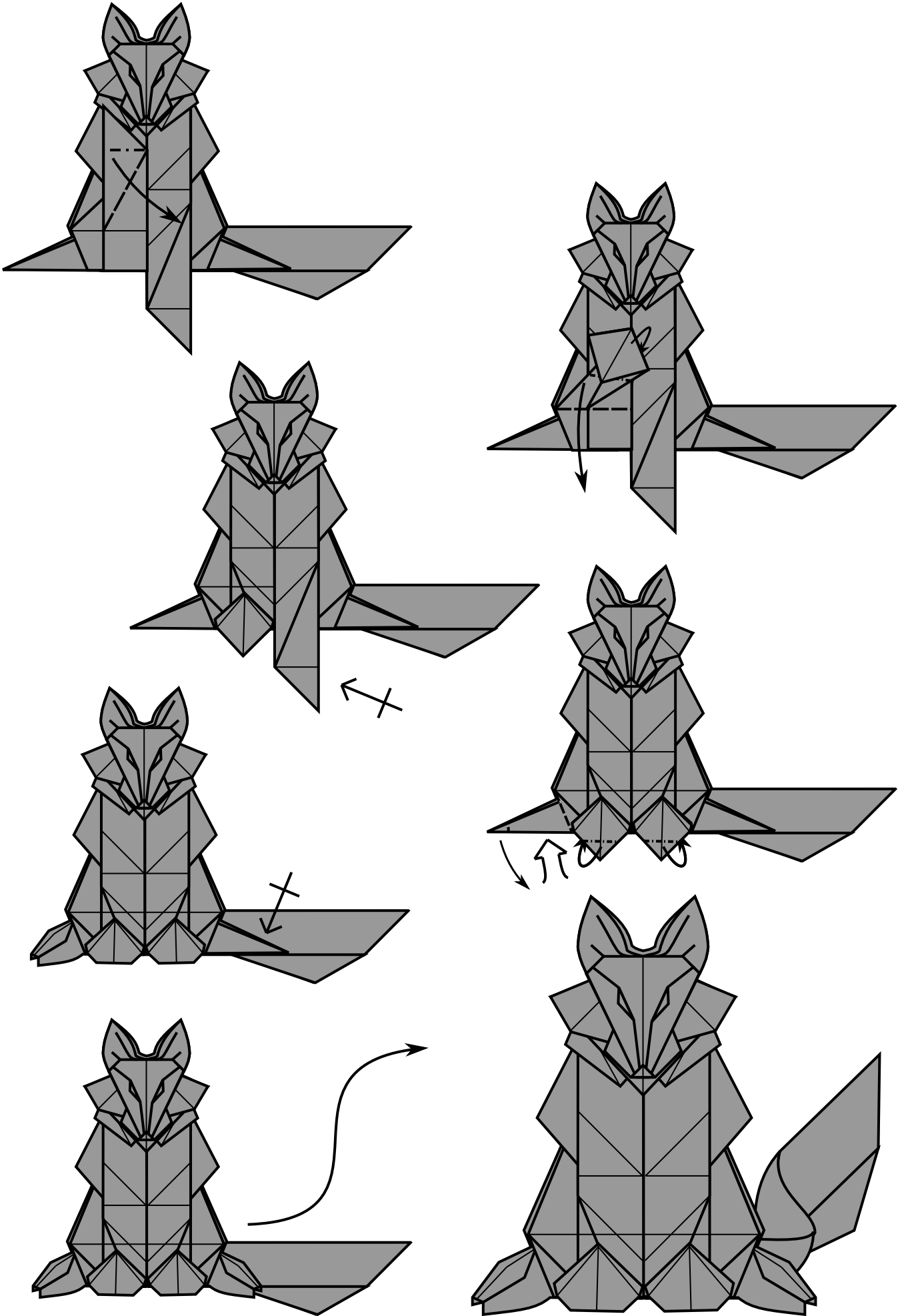

# Crab

Evolution is a funny thing. It isn't as smooth or as streamlined as people think. Odd, redundant, and downright useless relics still linger in every animal, despite the appearance otherwise.

This model is the culmination of years of learning and growing as a designer, with every dead end and new idea on full display.

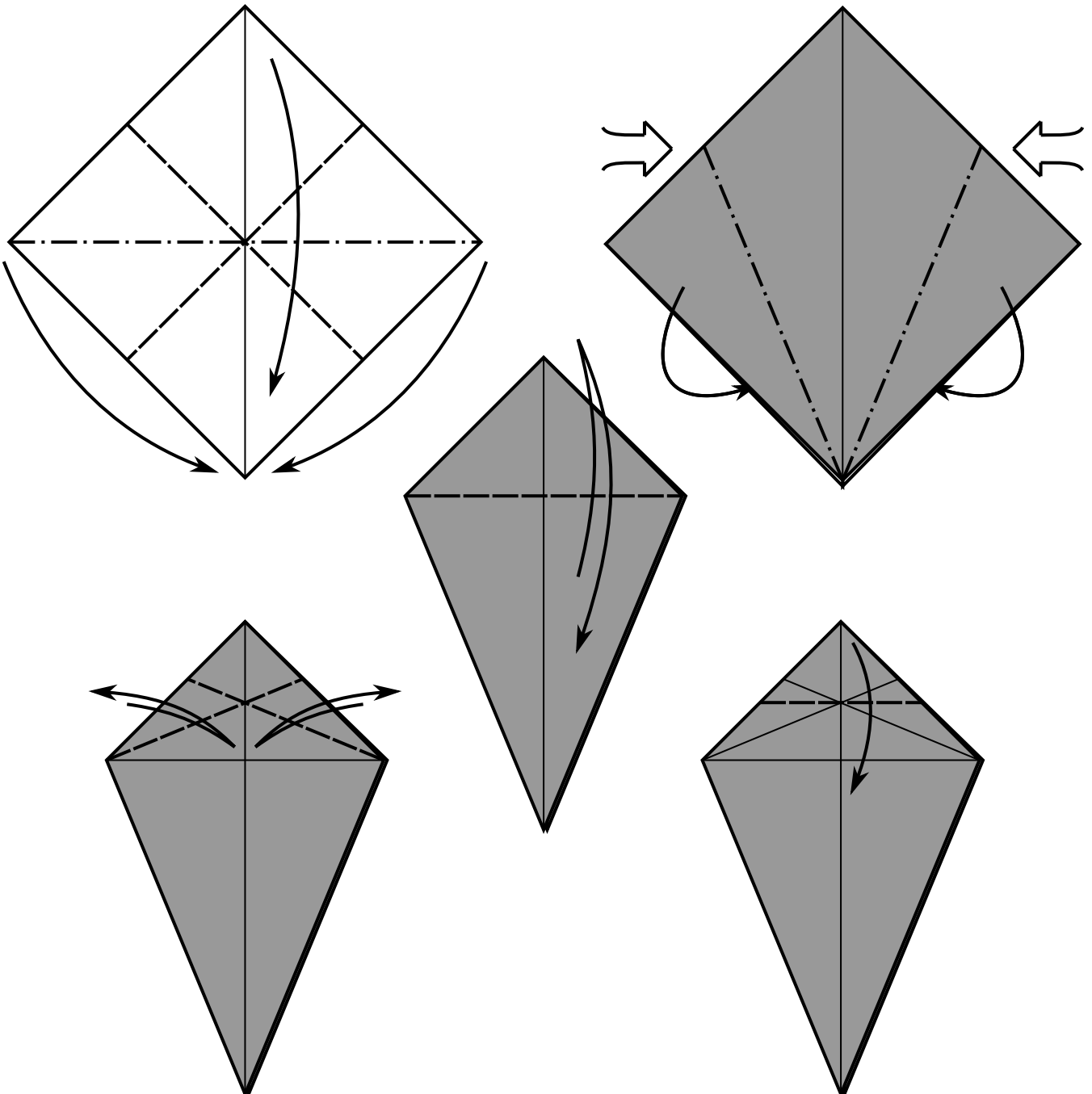

The Bases of Folding

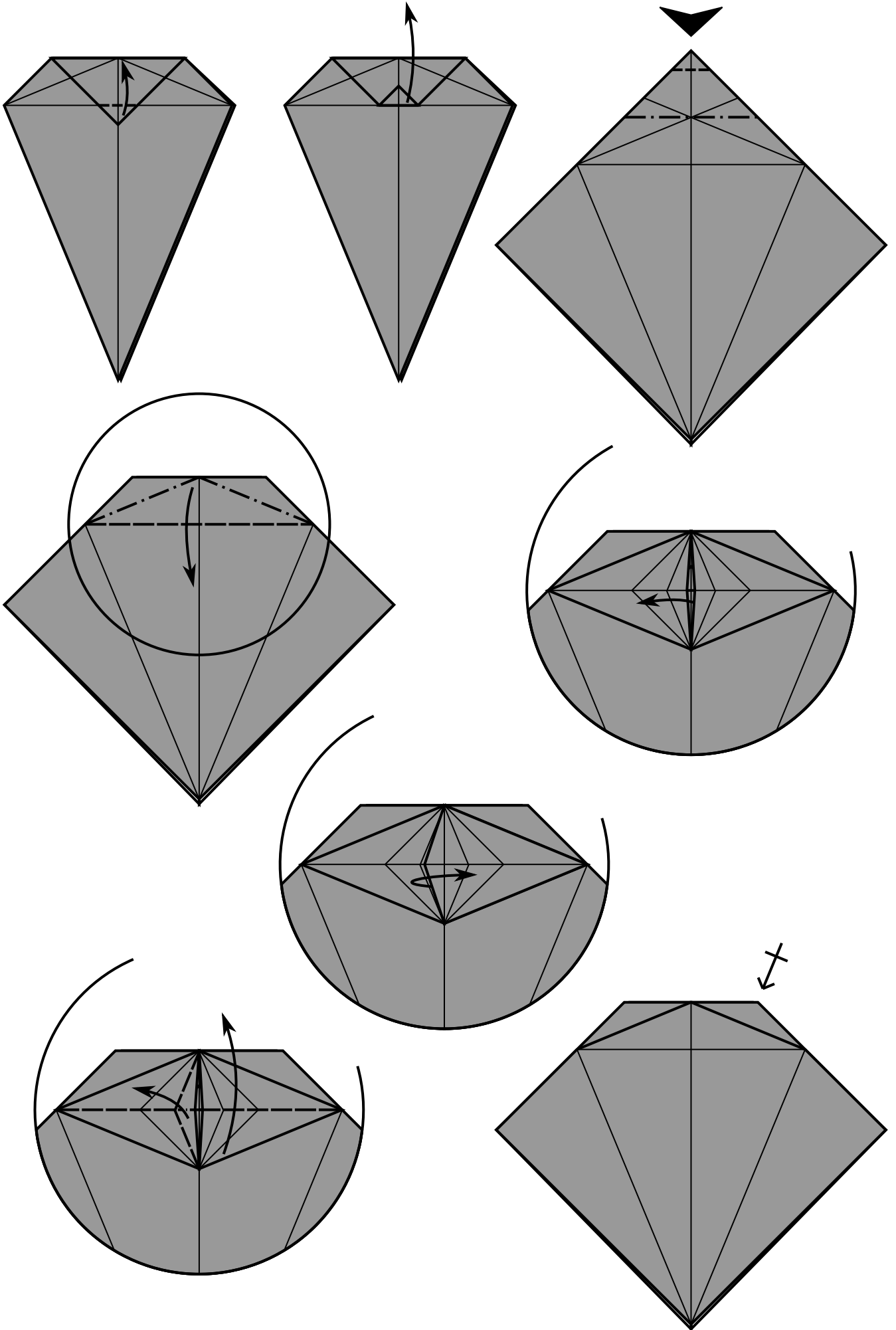

The Bases of Folding

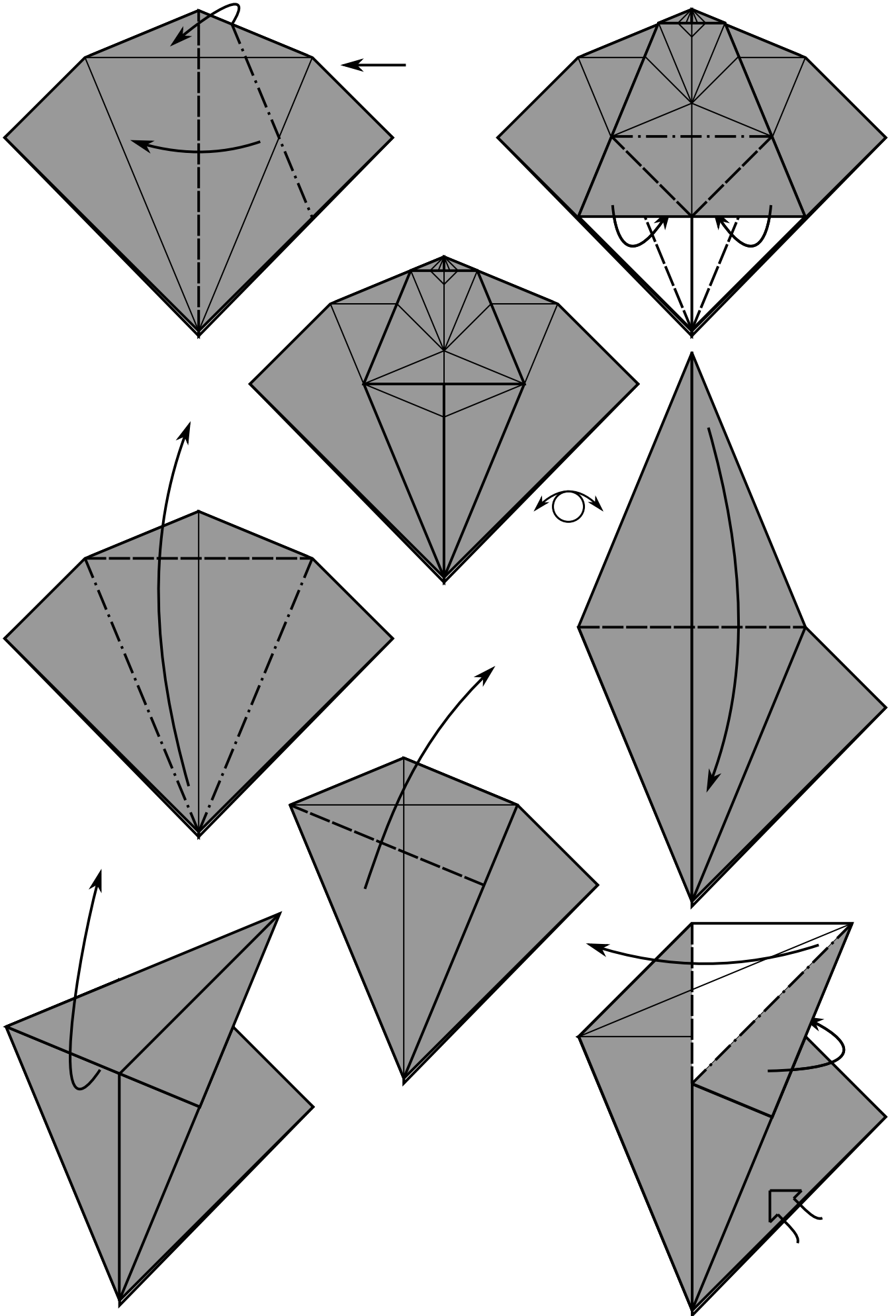

The Bases of Folding

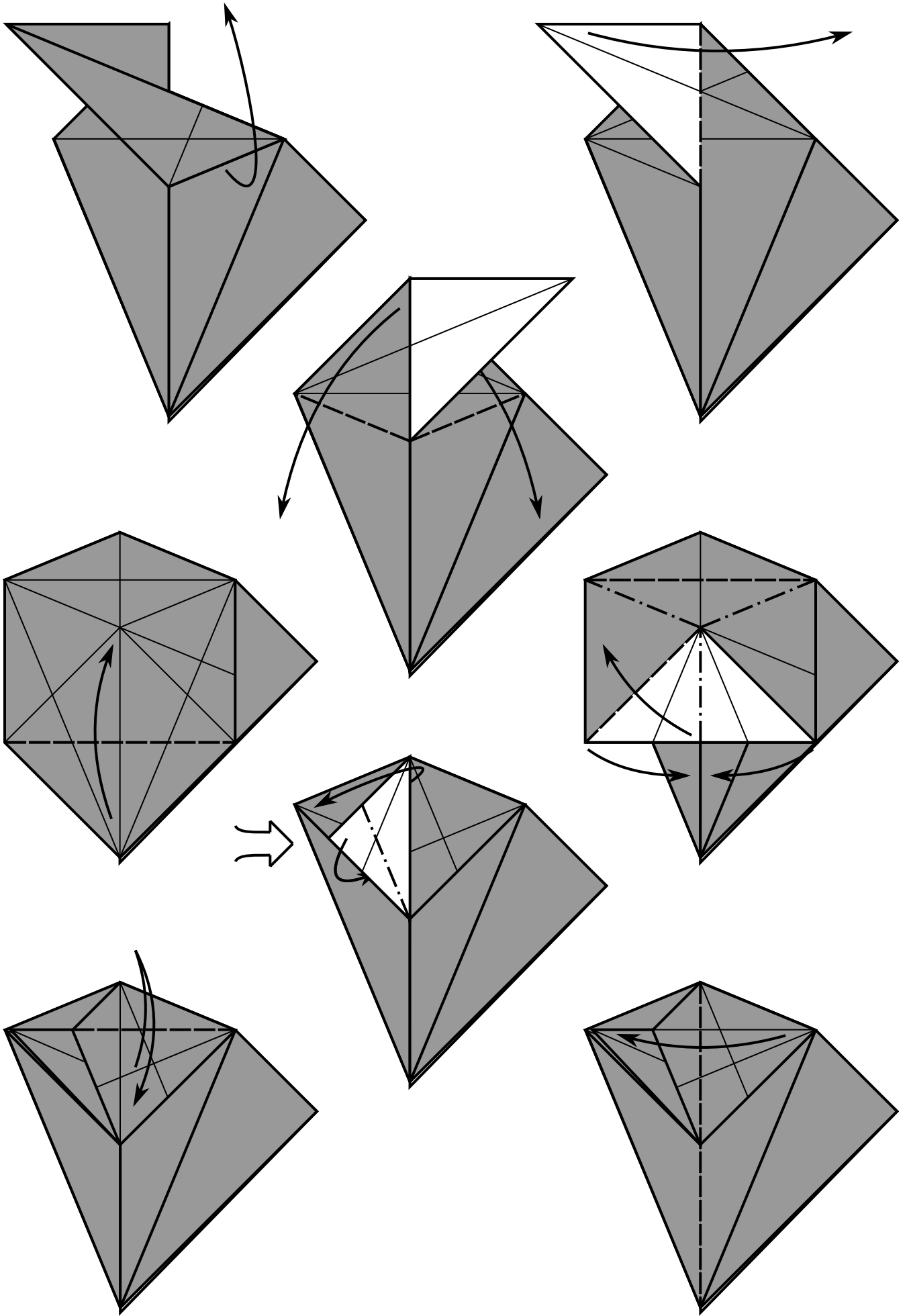

The Bases of Folding

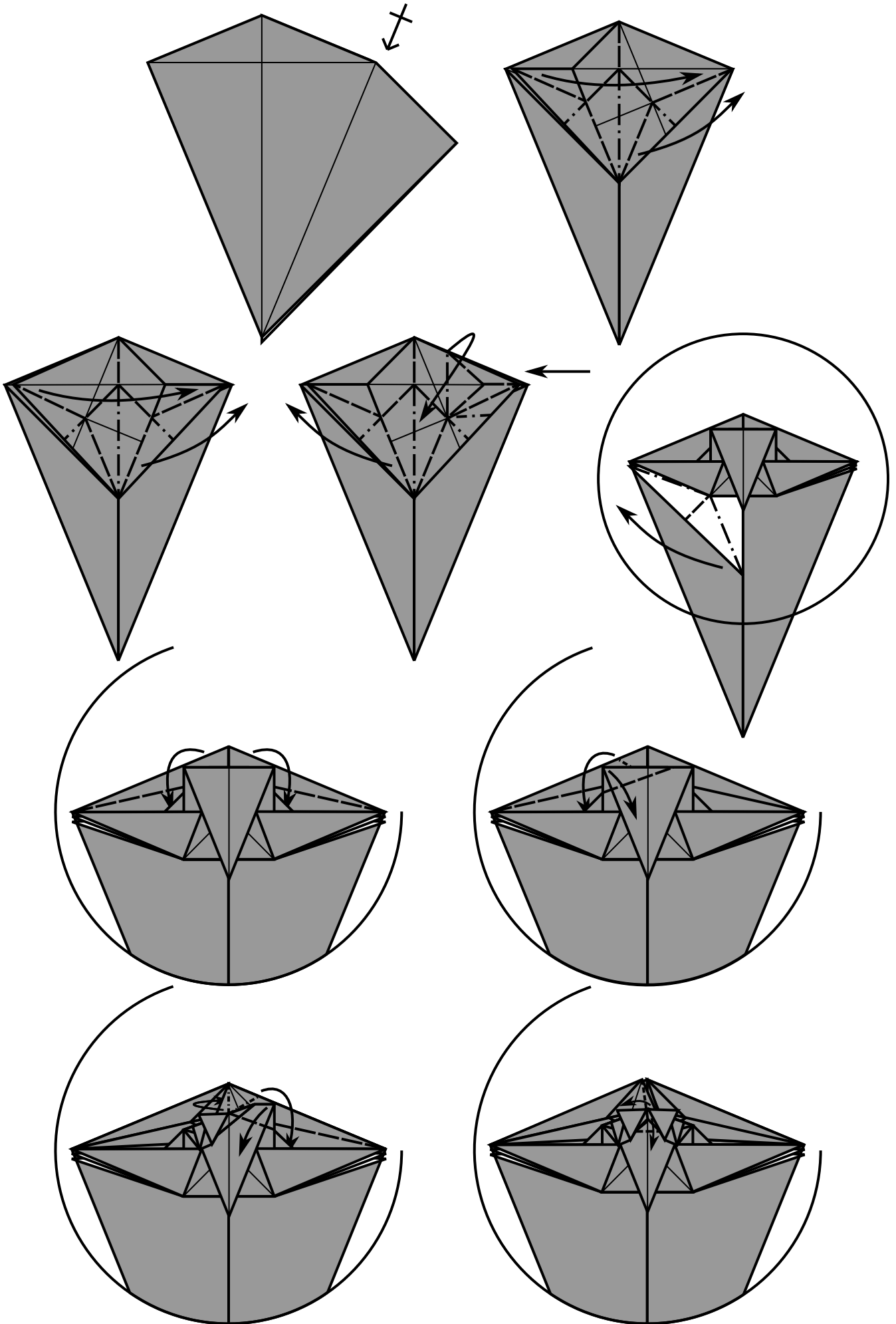

# The Bases of Folding

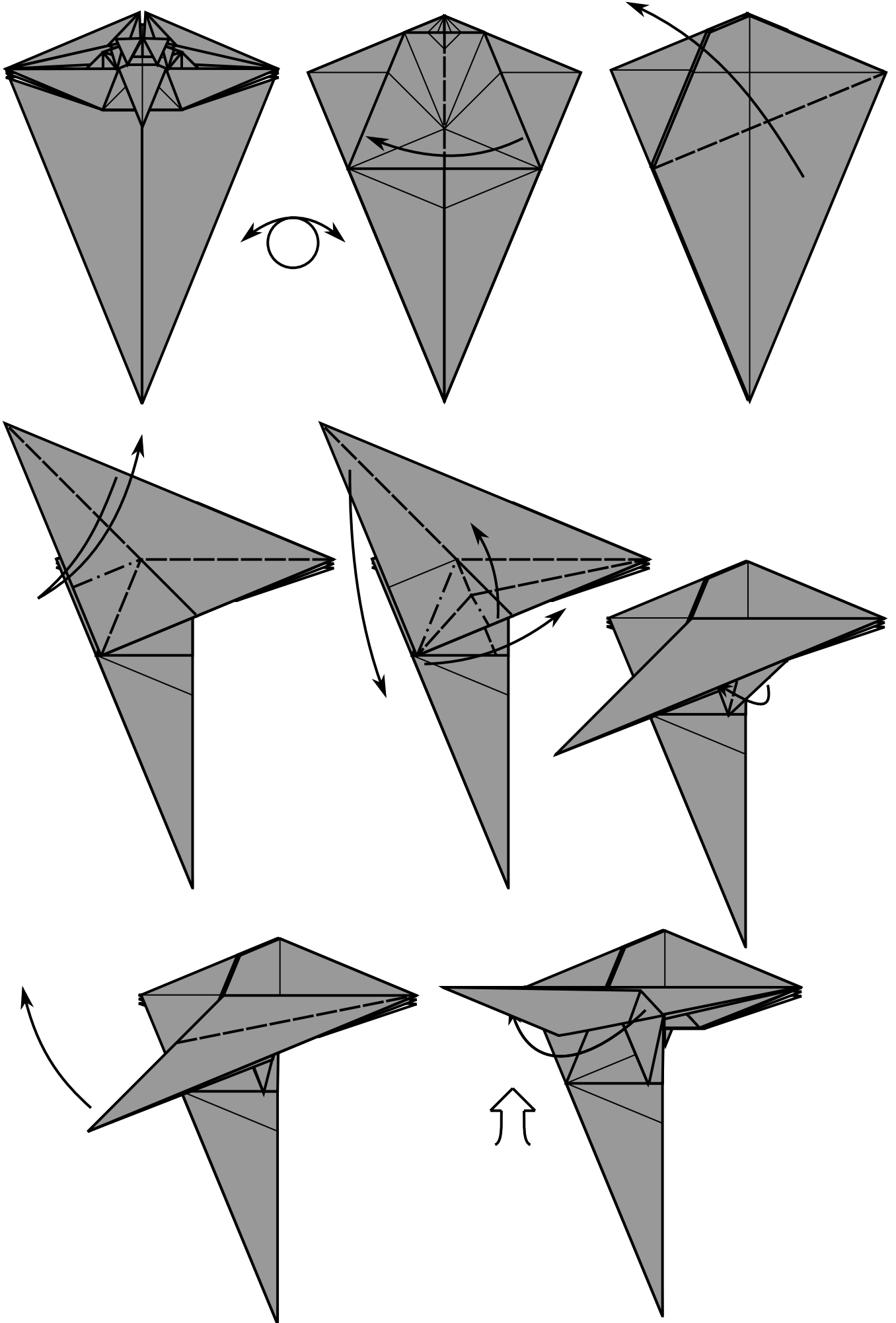



The Bases of Folding

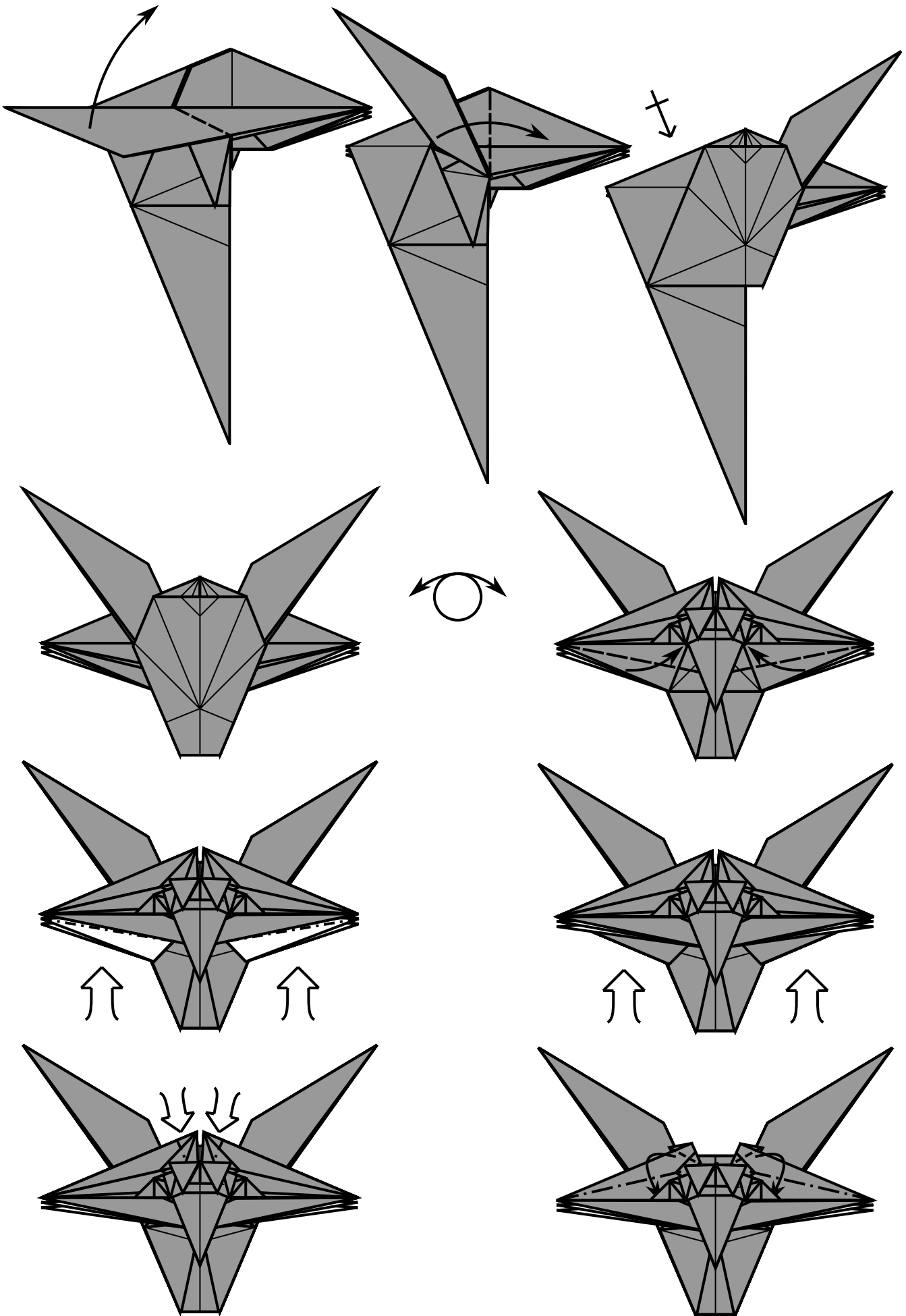

The Bases of Folding

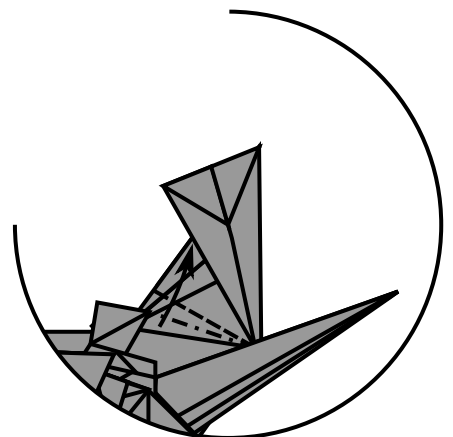
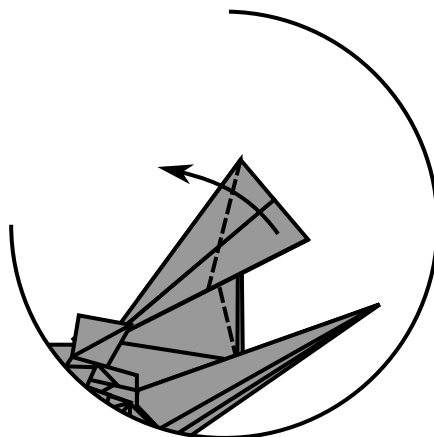
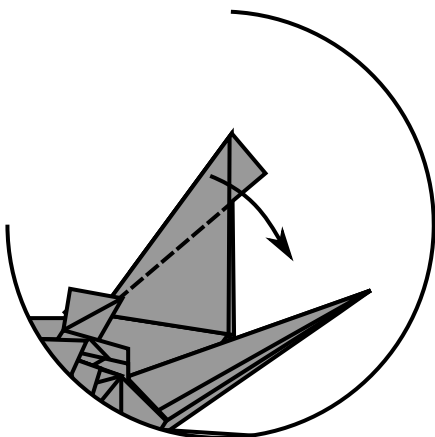
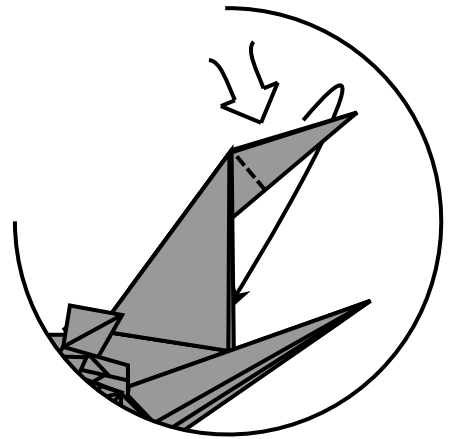
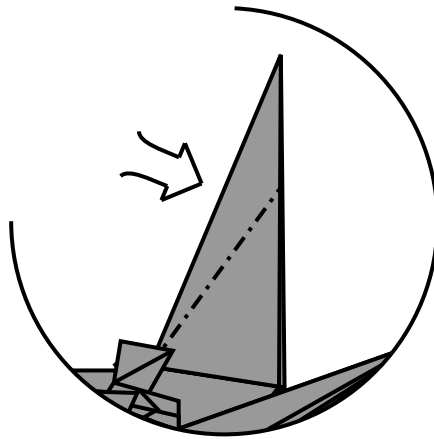
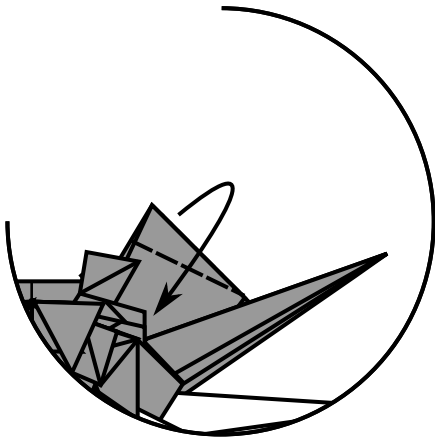
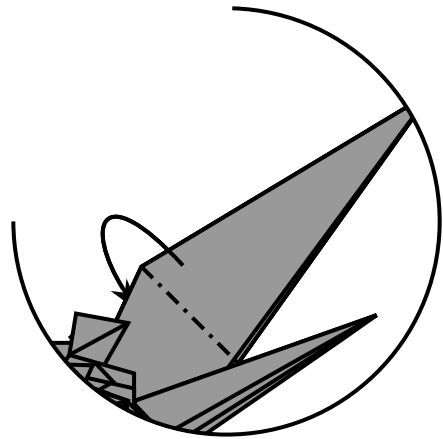
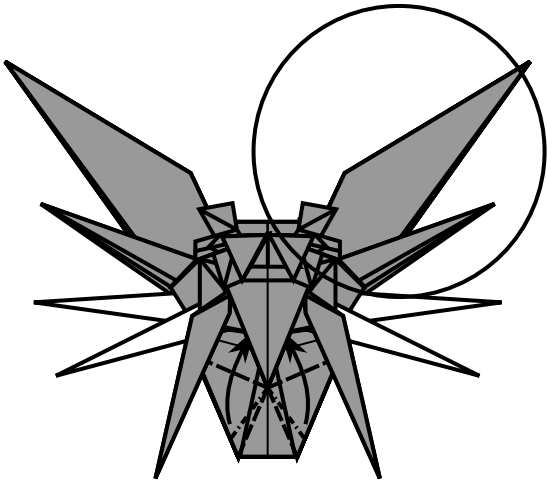
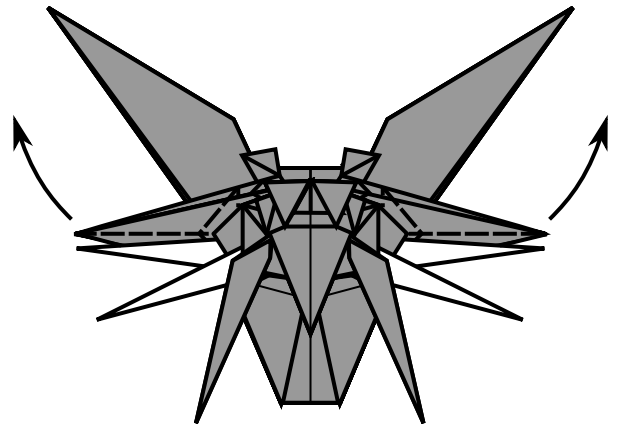
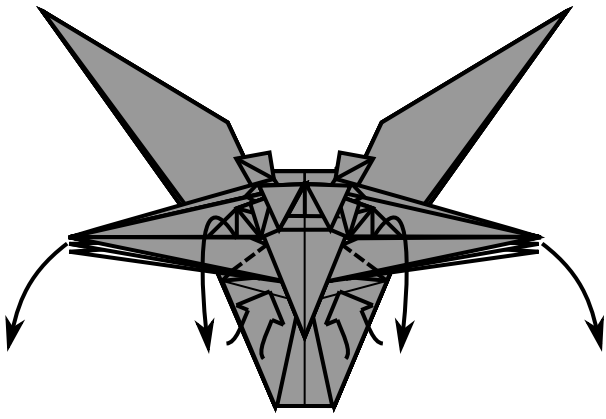

# The Bases of Folding

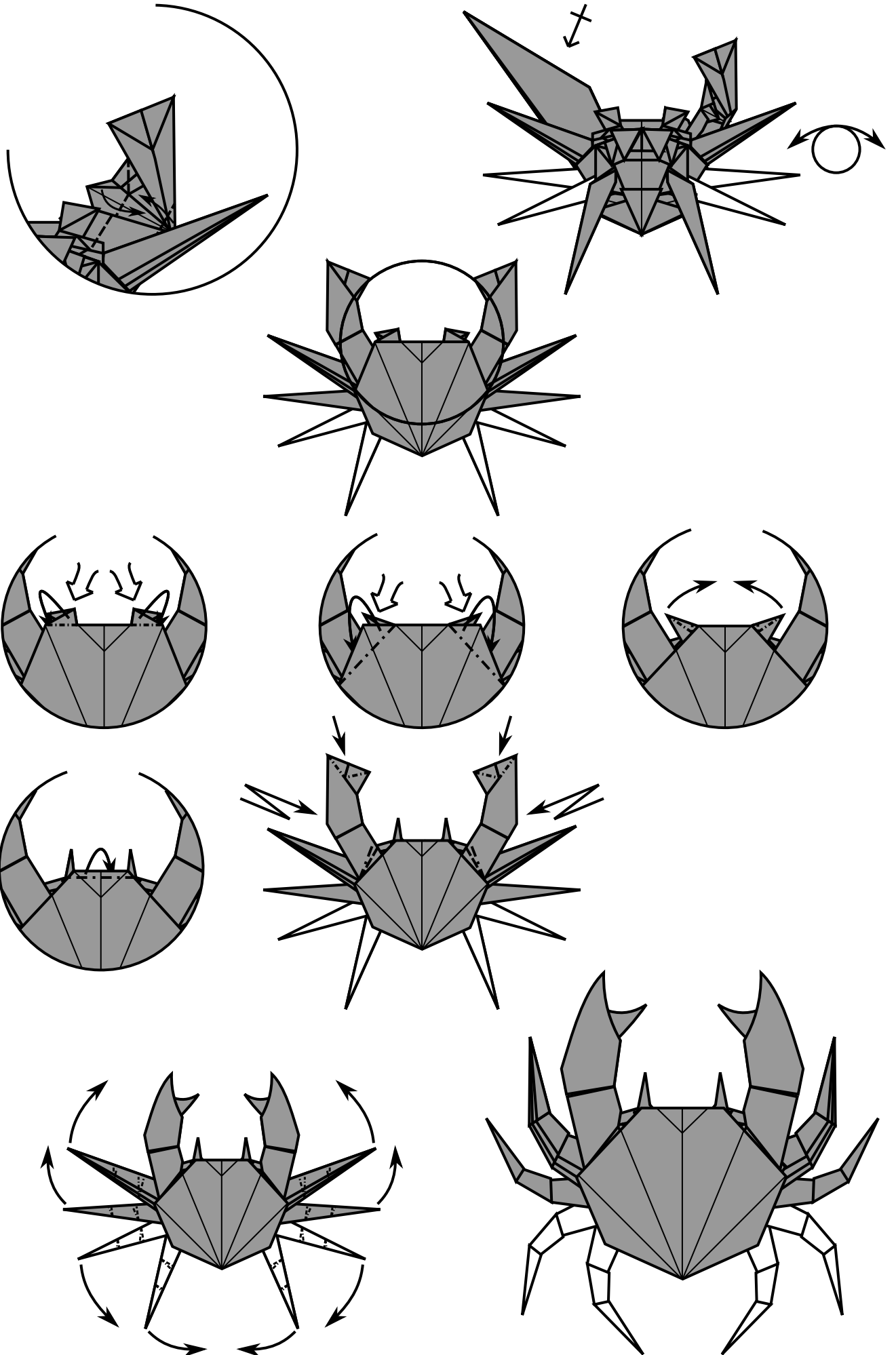

# Blobfish

Despite us moving from the savannah to suburbia, humans are still captivated by nature. From the vibrant feathers of a peacock to the terrifying vision of an anglerfish, we find the beauty and majesty of our world infinitely mesmerizing.

The blobfish is, by most standards, an ugly creature. But even ugliness in its own way is endearing to us, making the blobfish a favorite of mine and many others.

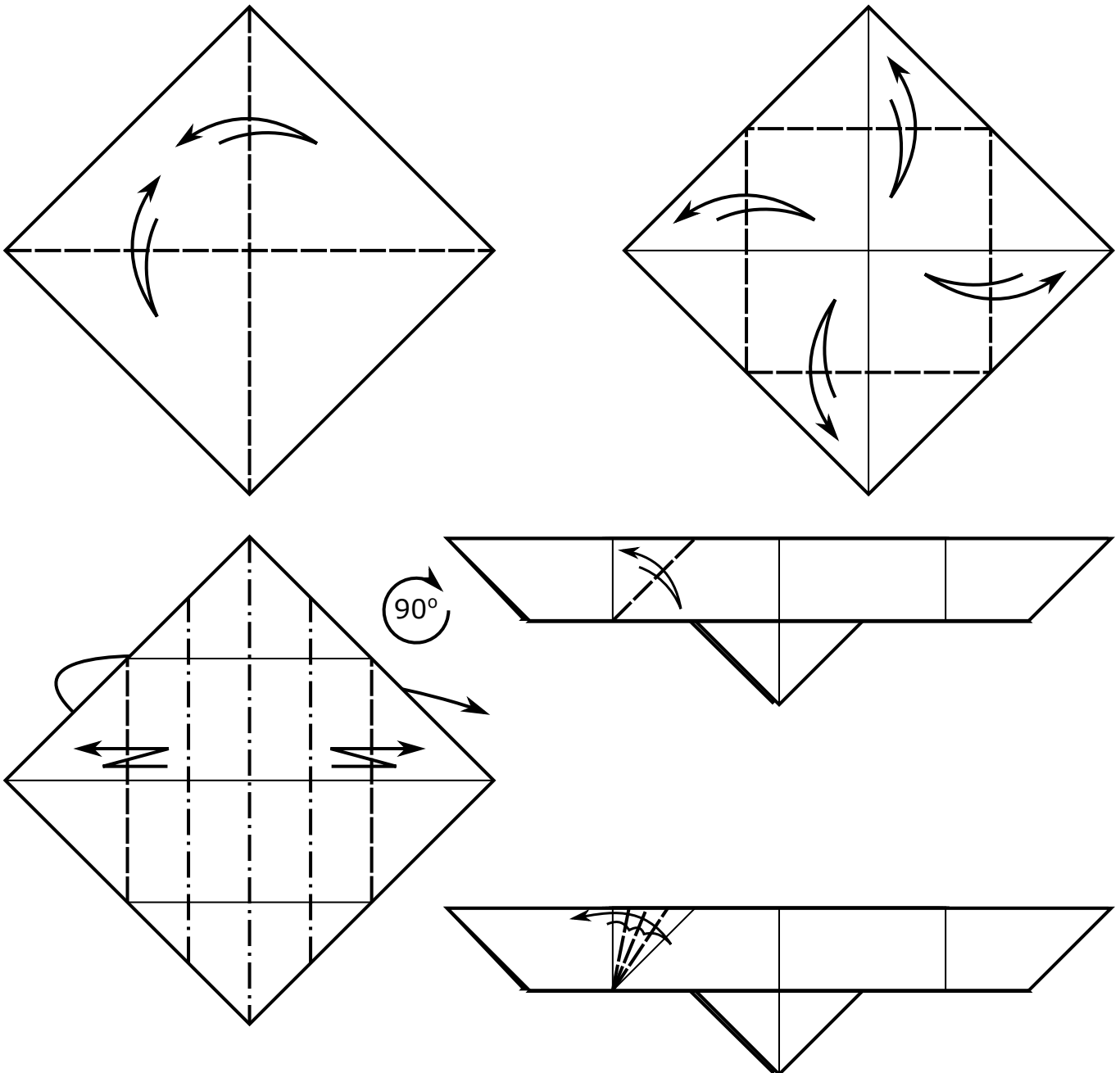
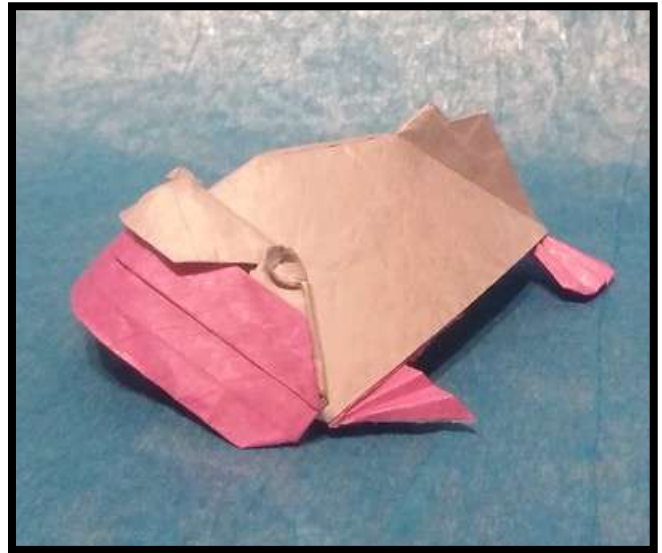

# The Bases of Folding

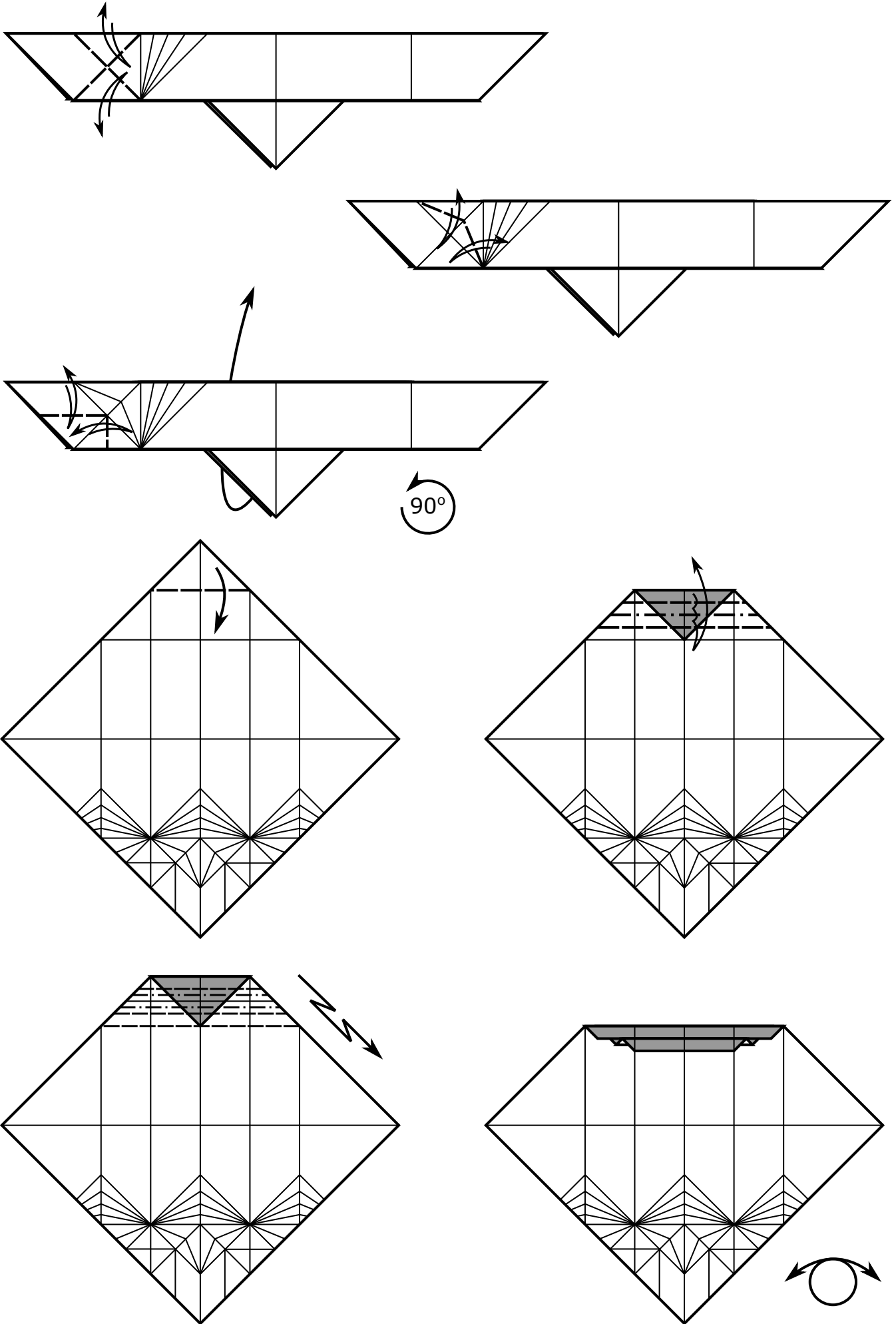

# The Bases of Folding

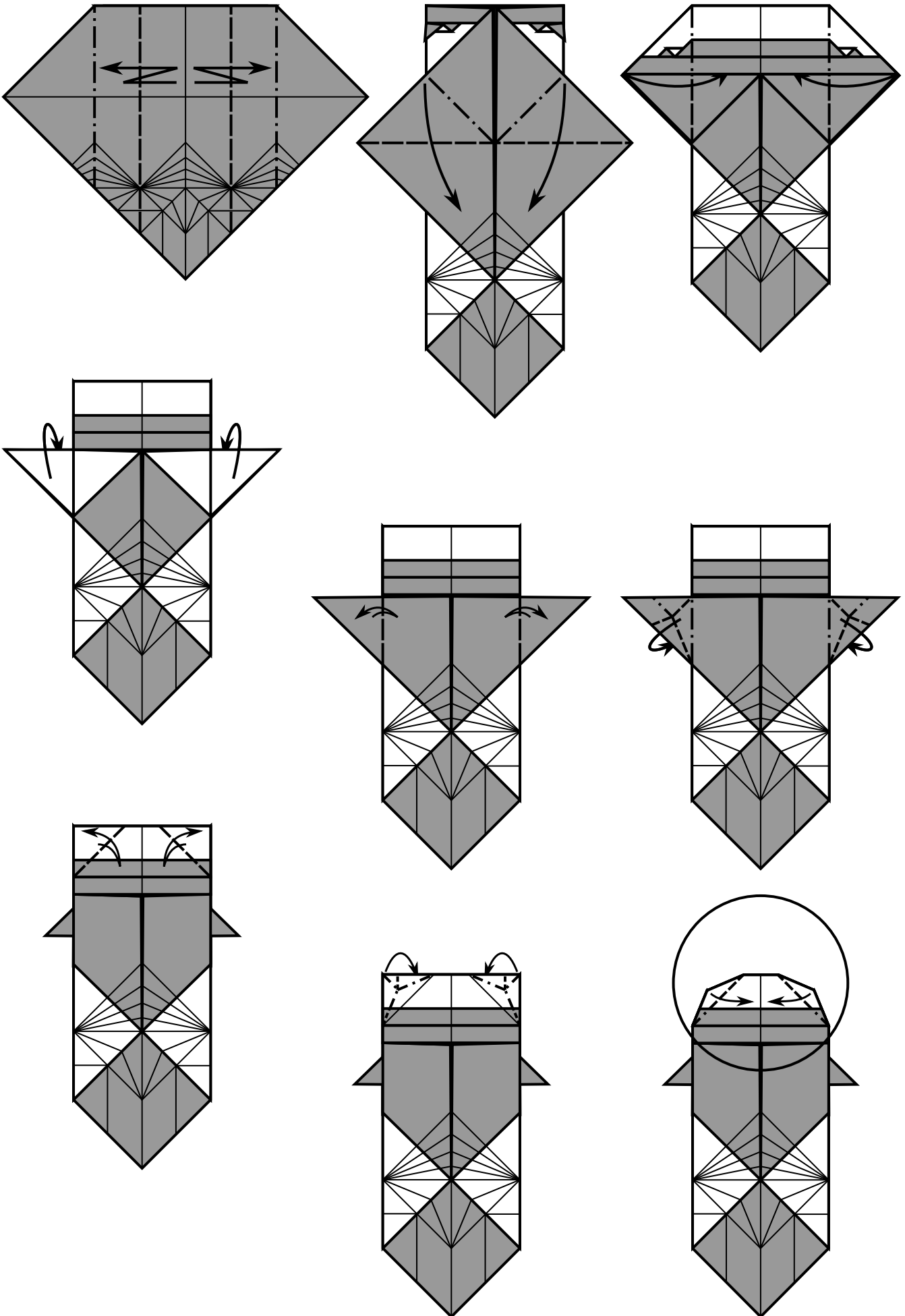

# The Bases of Folding

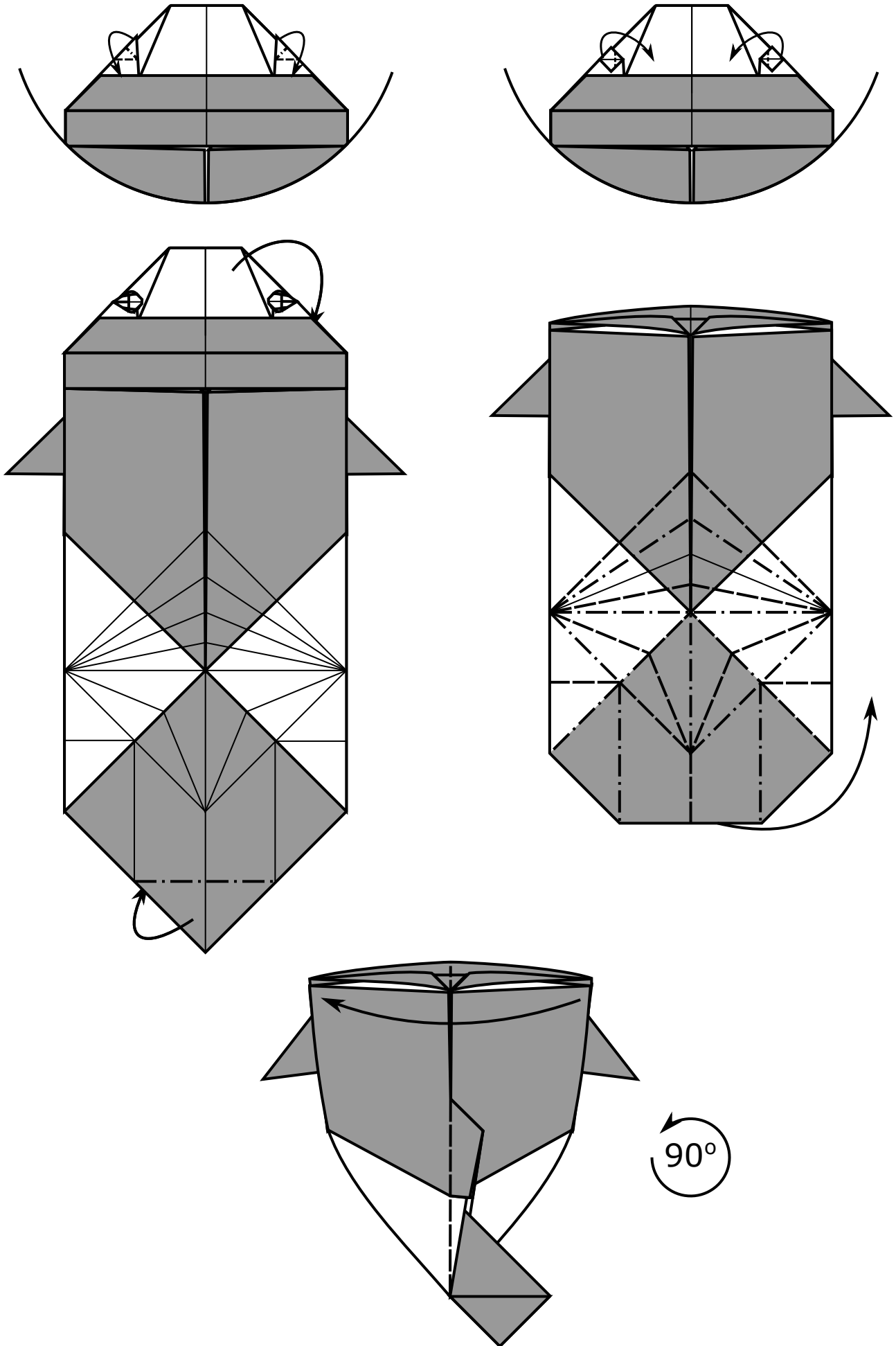

# The Bases of Folding

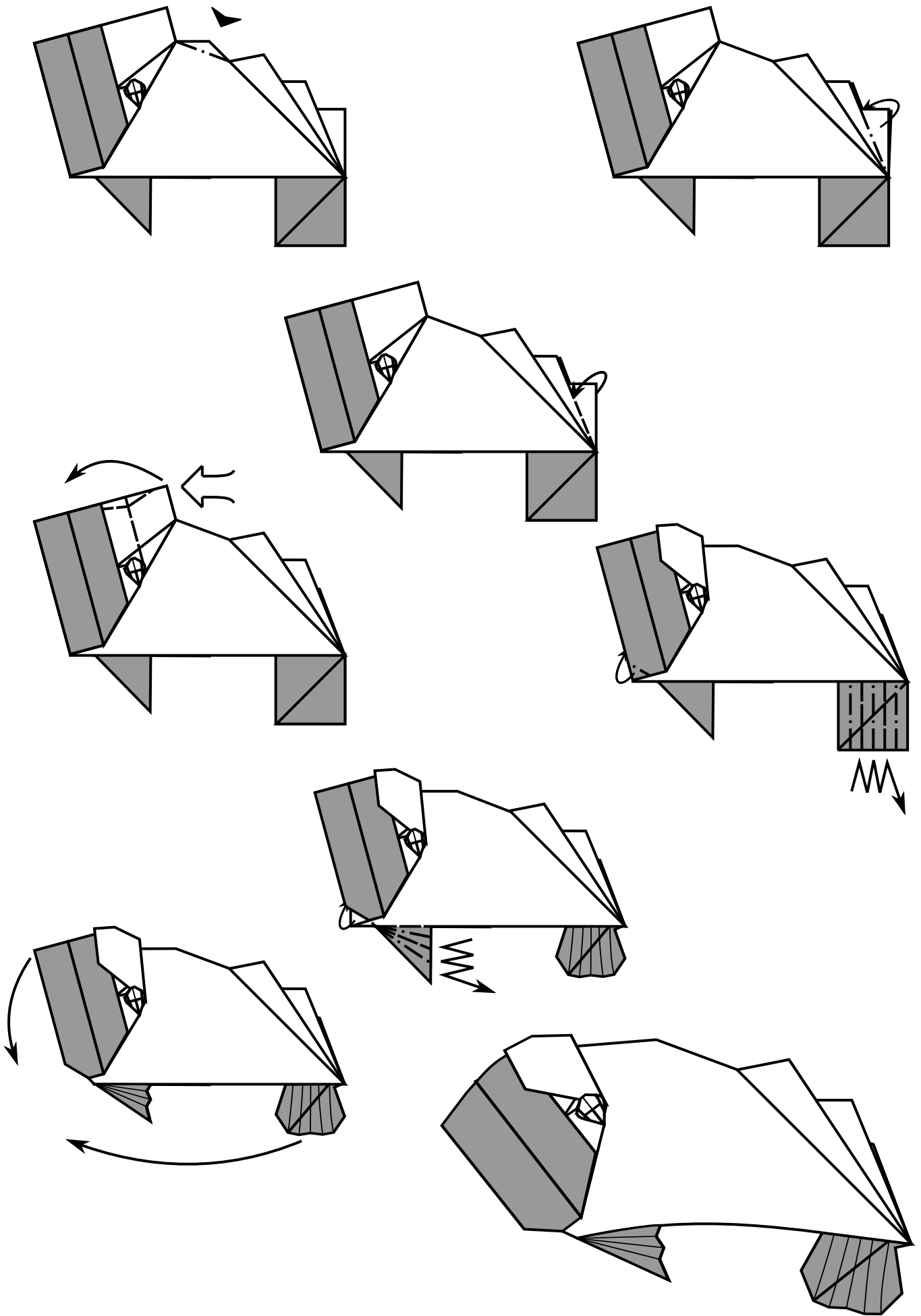



# Lophorina

Did you know that there are three species of lophorina, and that the one in this book is the *lophorina niedda*? Even while making this model, I didn't know that either!

I also didn't know how to split a model into twentieths, was pretty unfamiliar with box pleating, and had never used a three by two rectangle before. You learn something new every day.

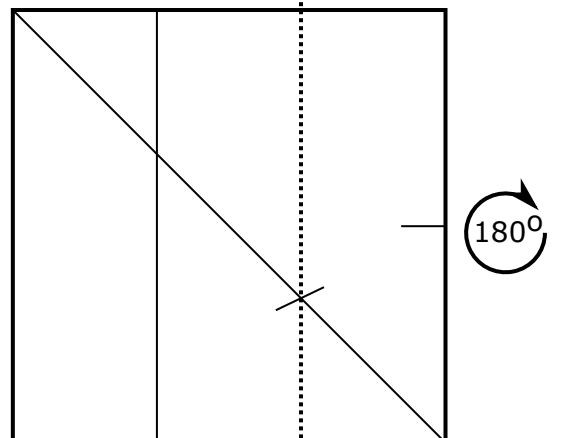
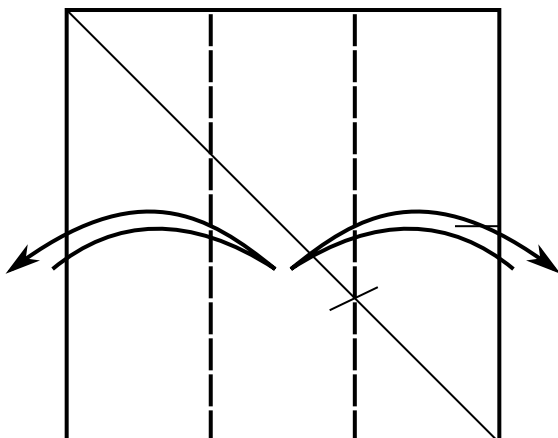
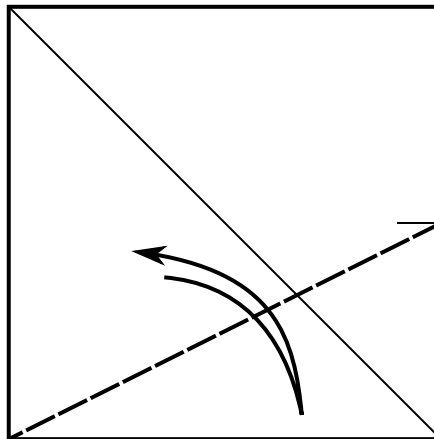
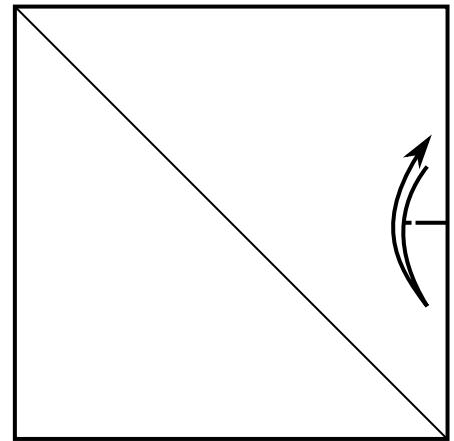
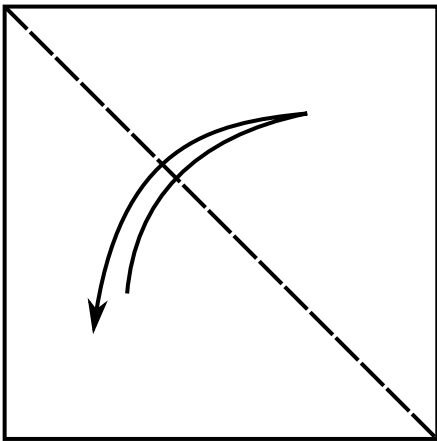

# The Bases of Folding

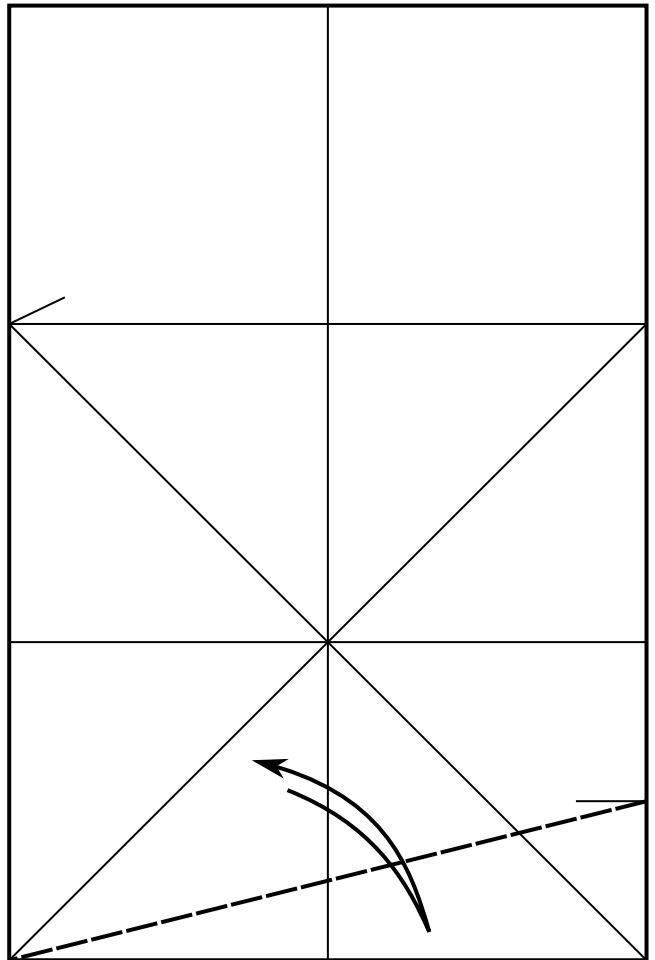
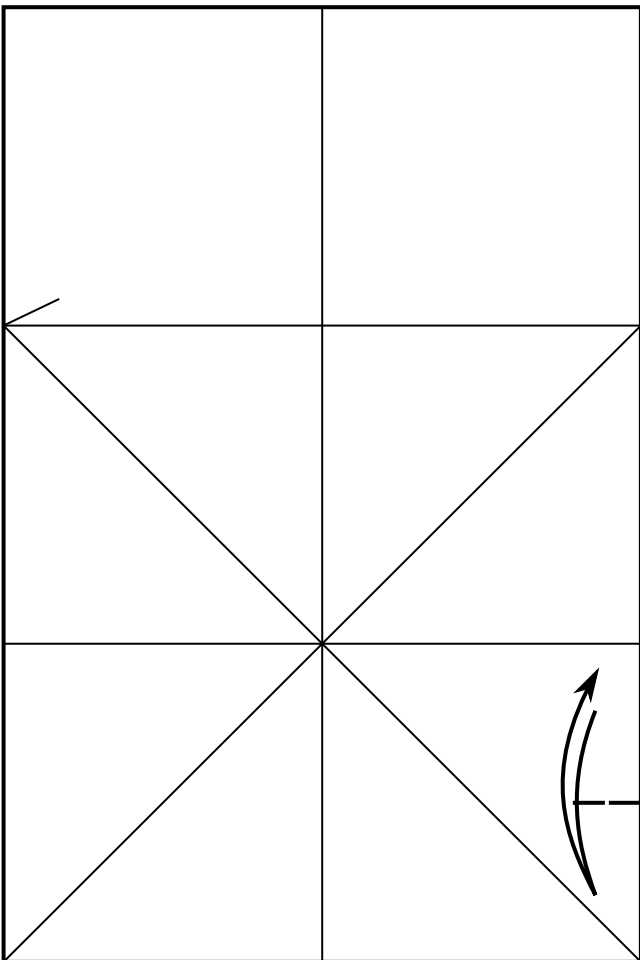
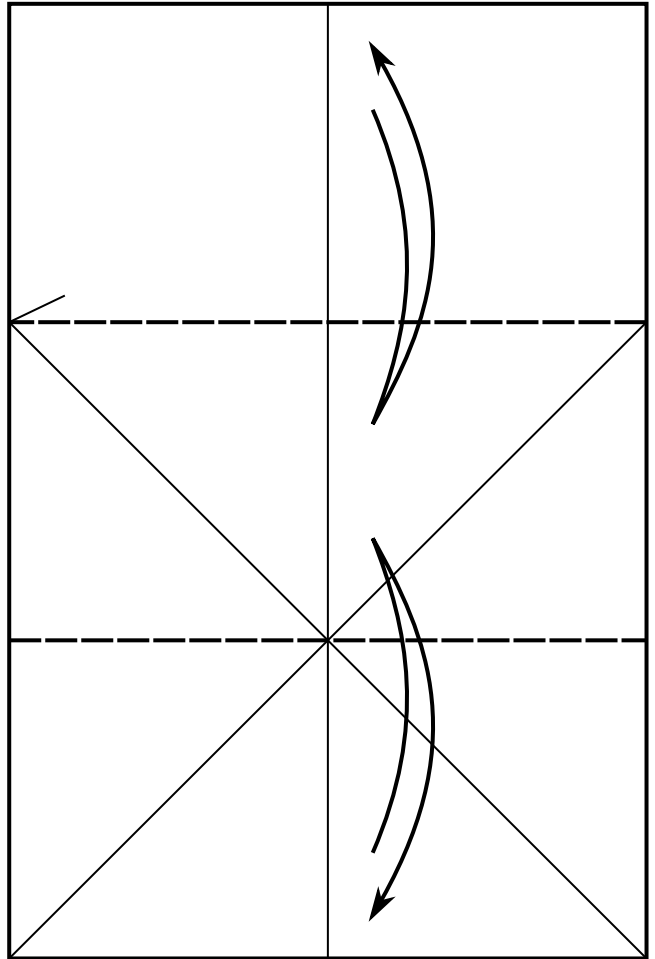
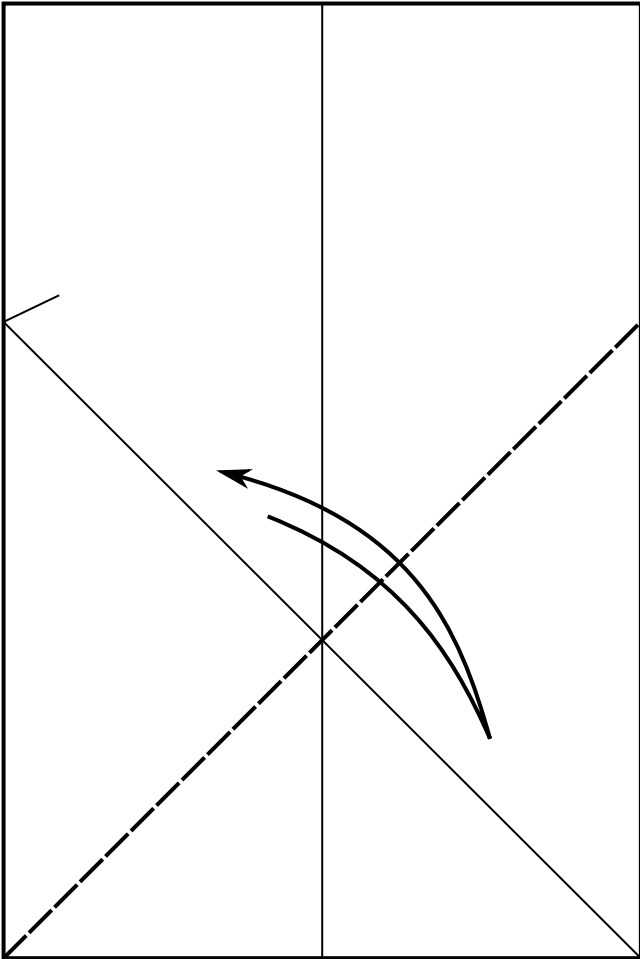

# The Bases of Folding

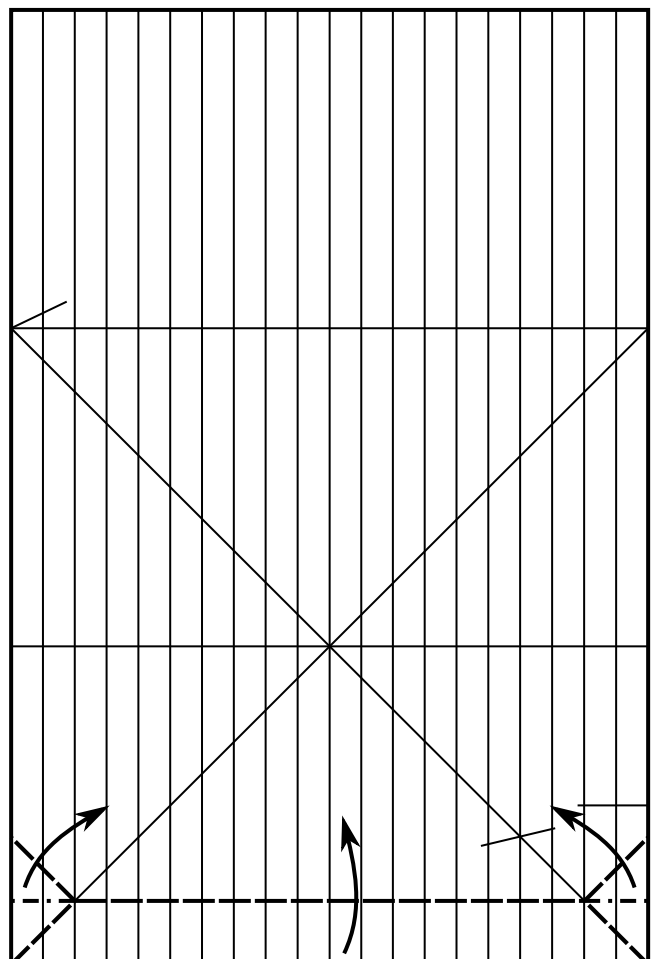
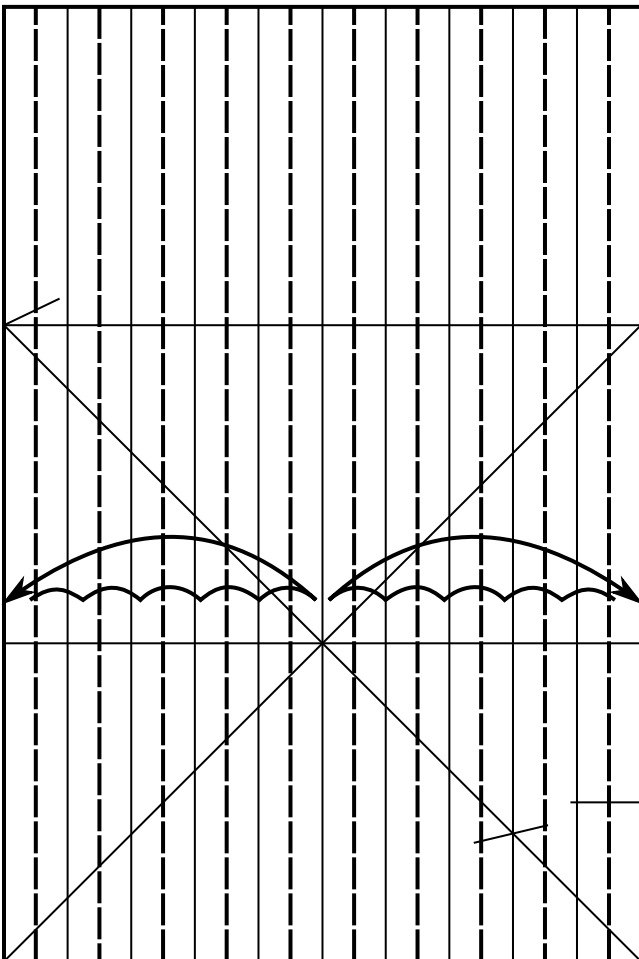
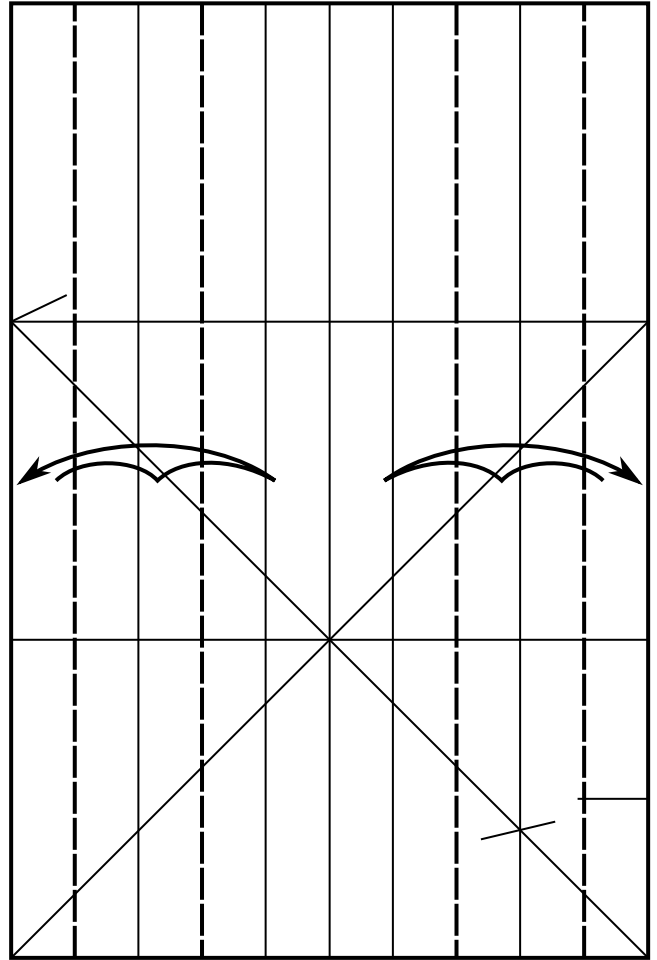
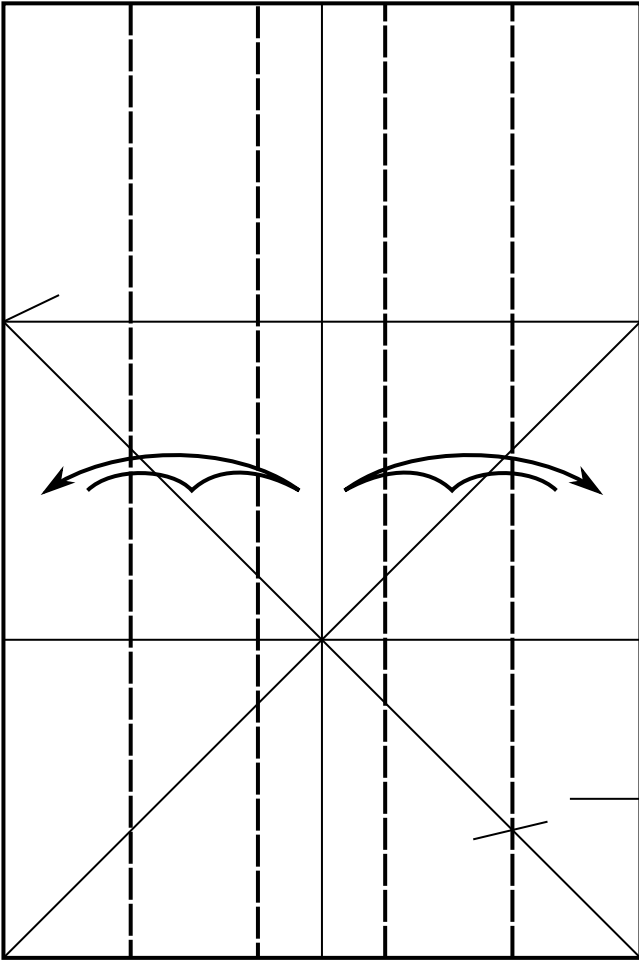

# The Bases of Folding

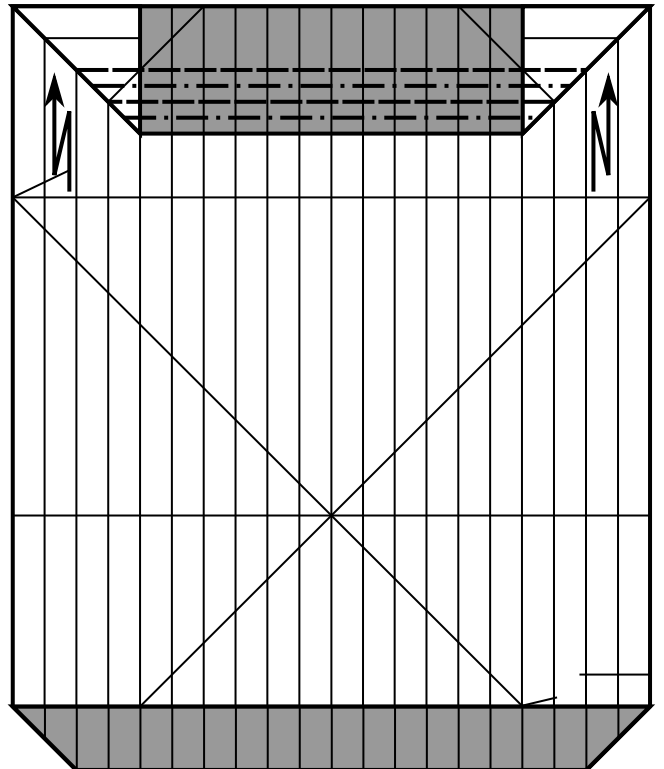
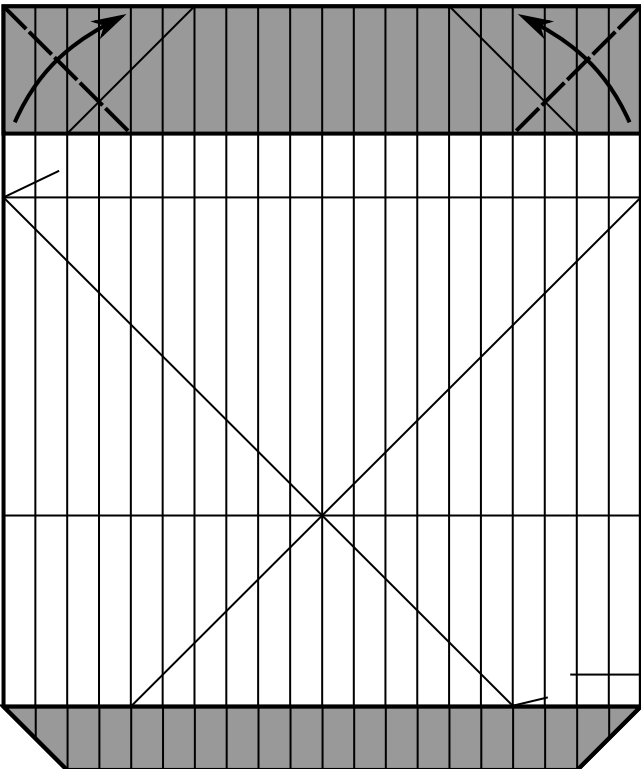
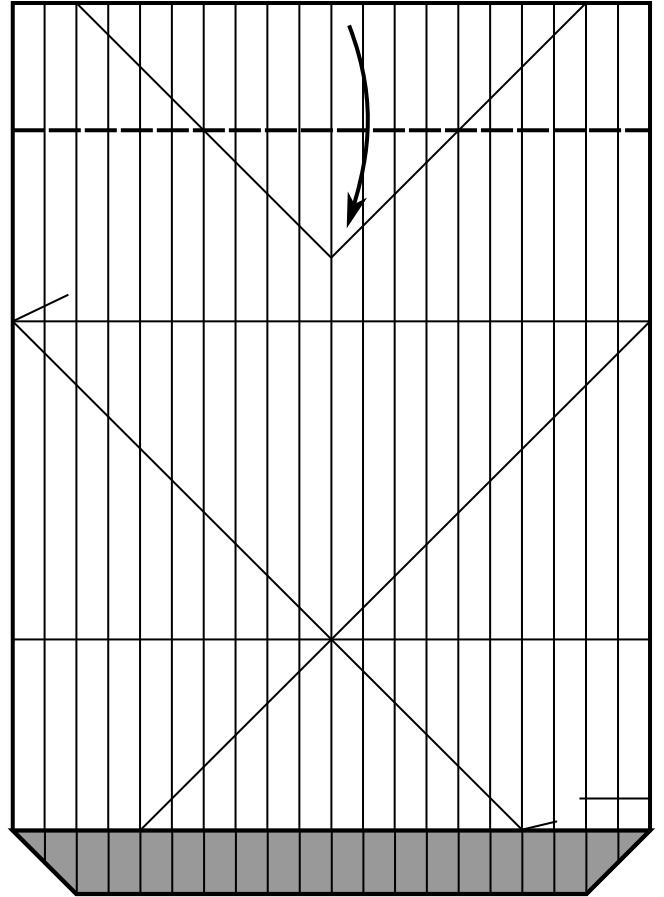
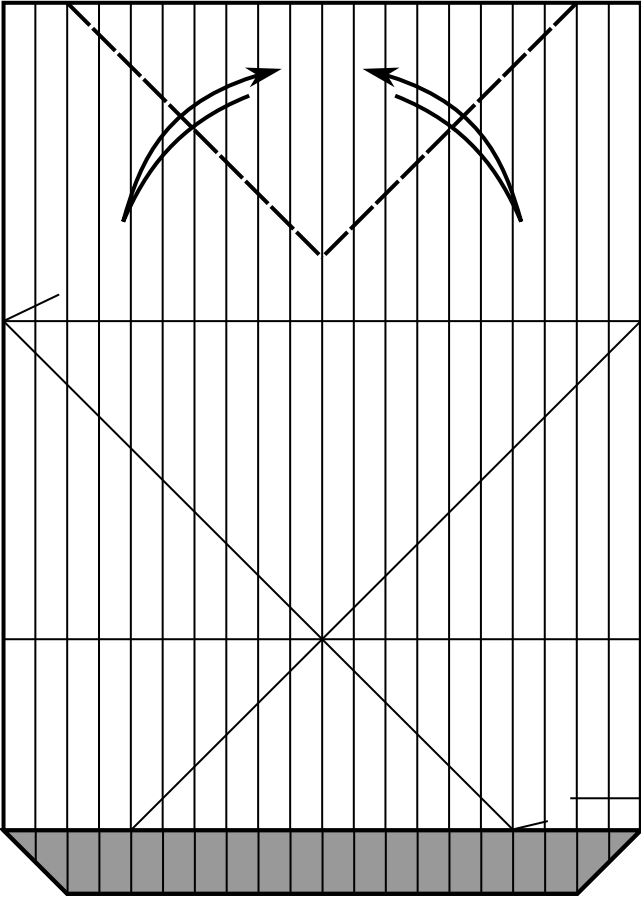

# The Bases of Folding

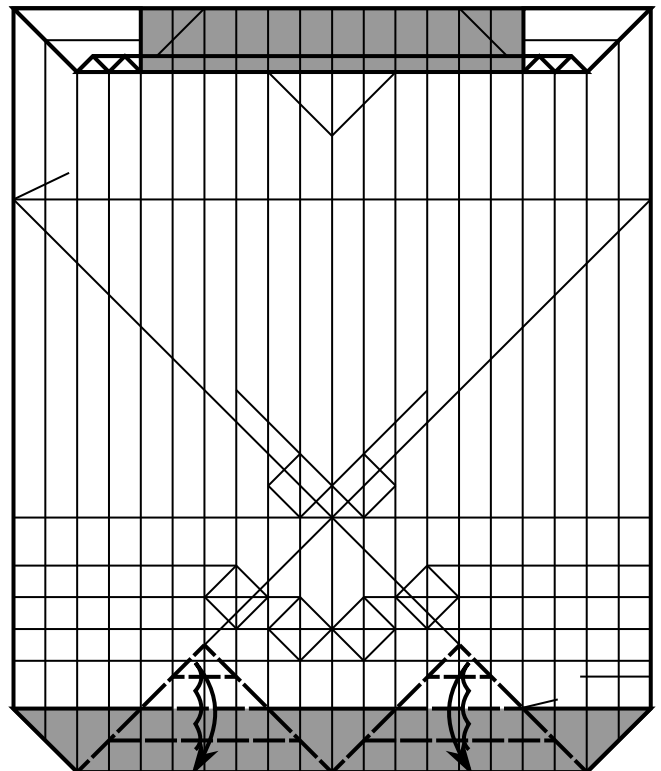
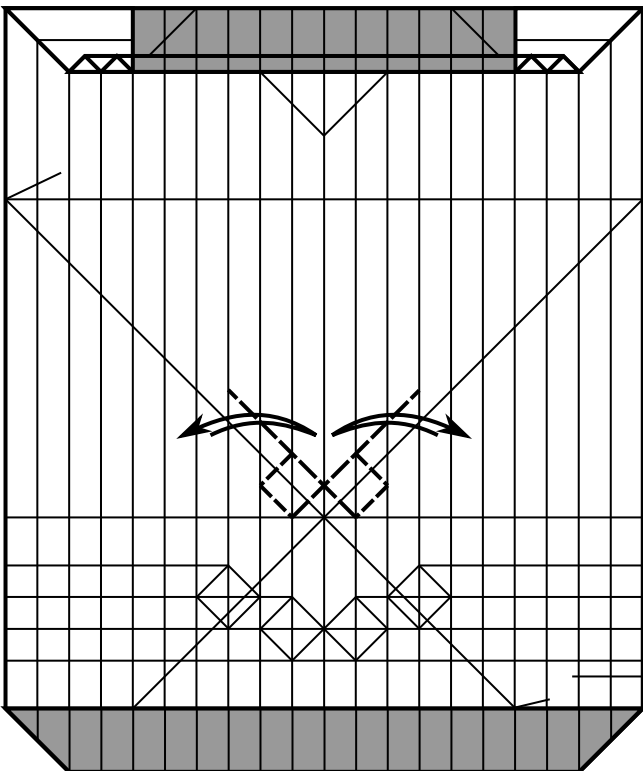
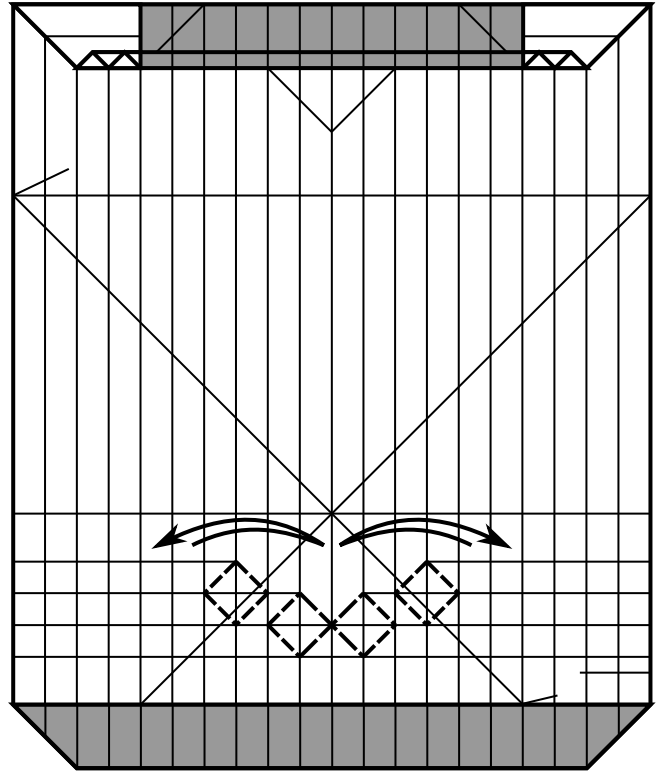
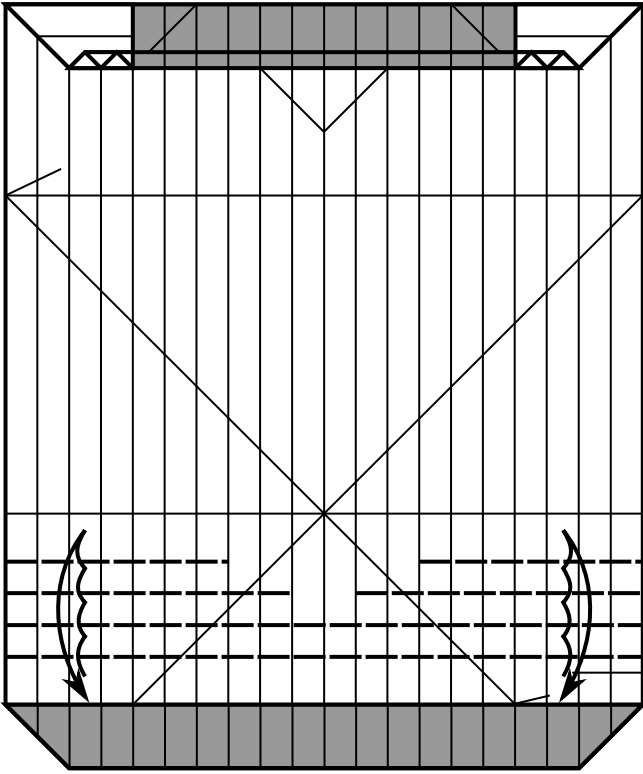

# The Bases of Folding

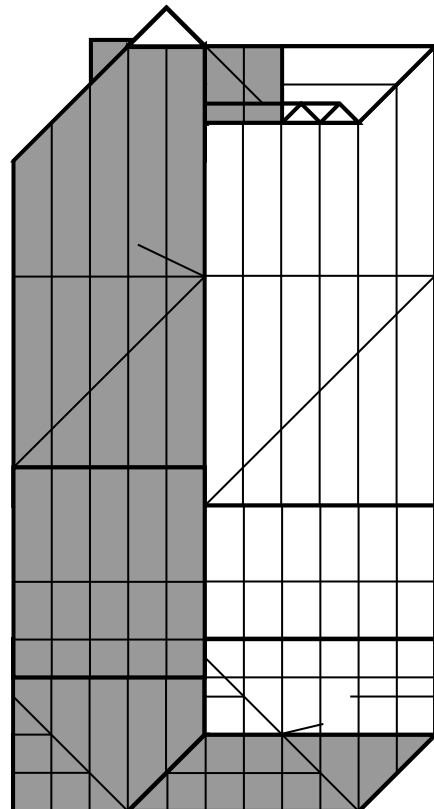
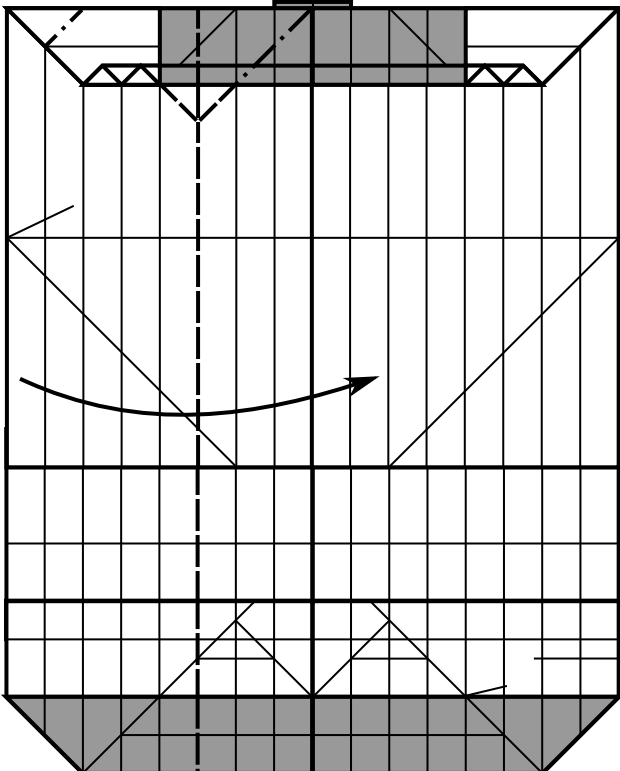
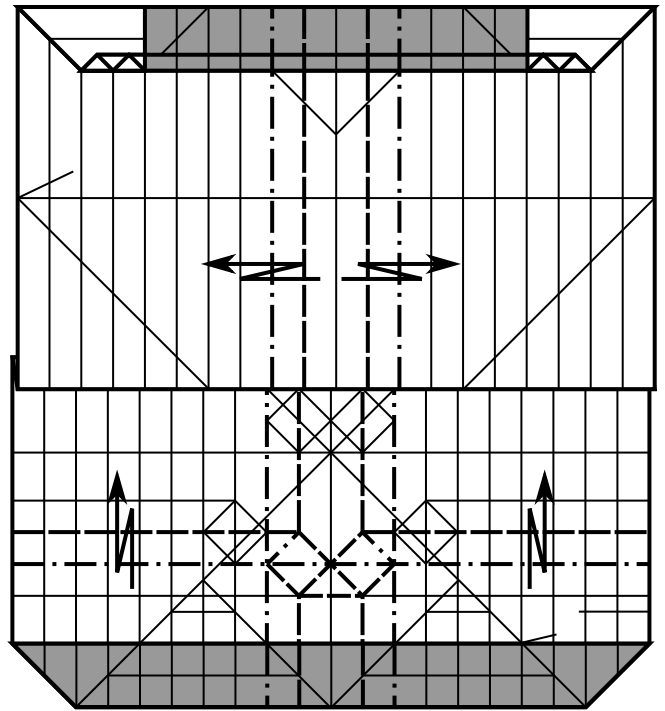
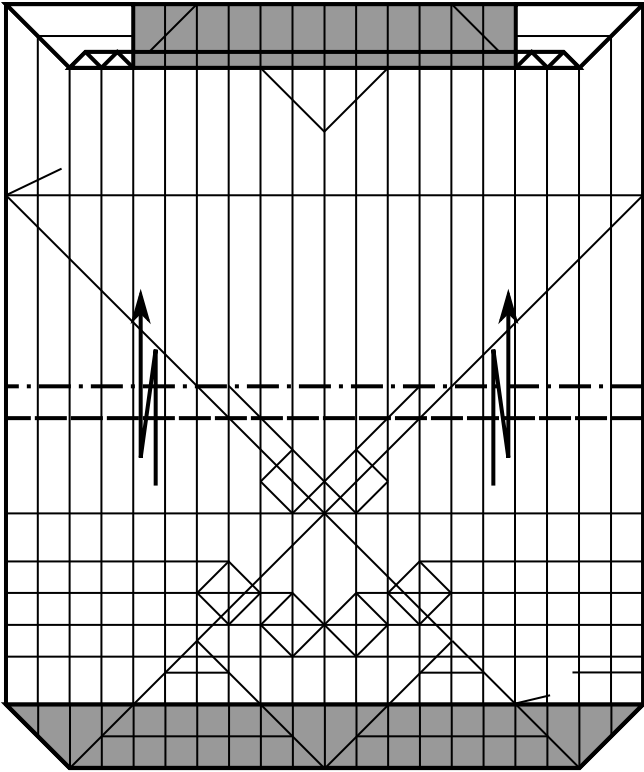

# The Bases of Folding

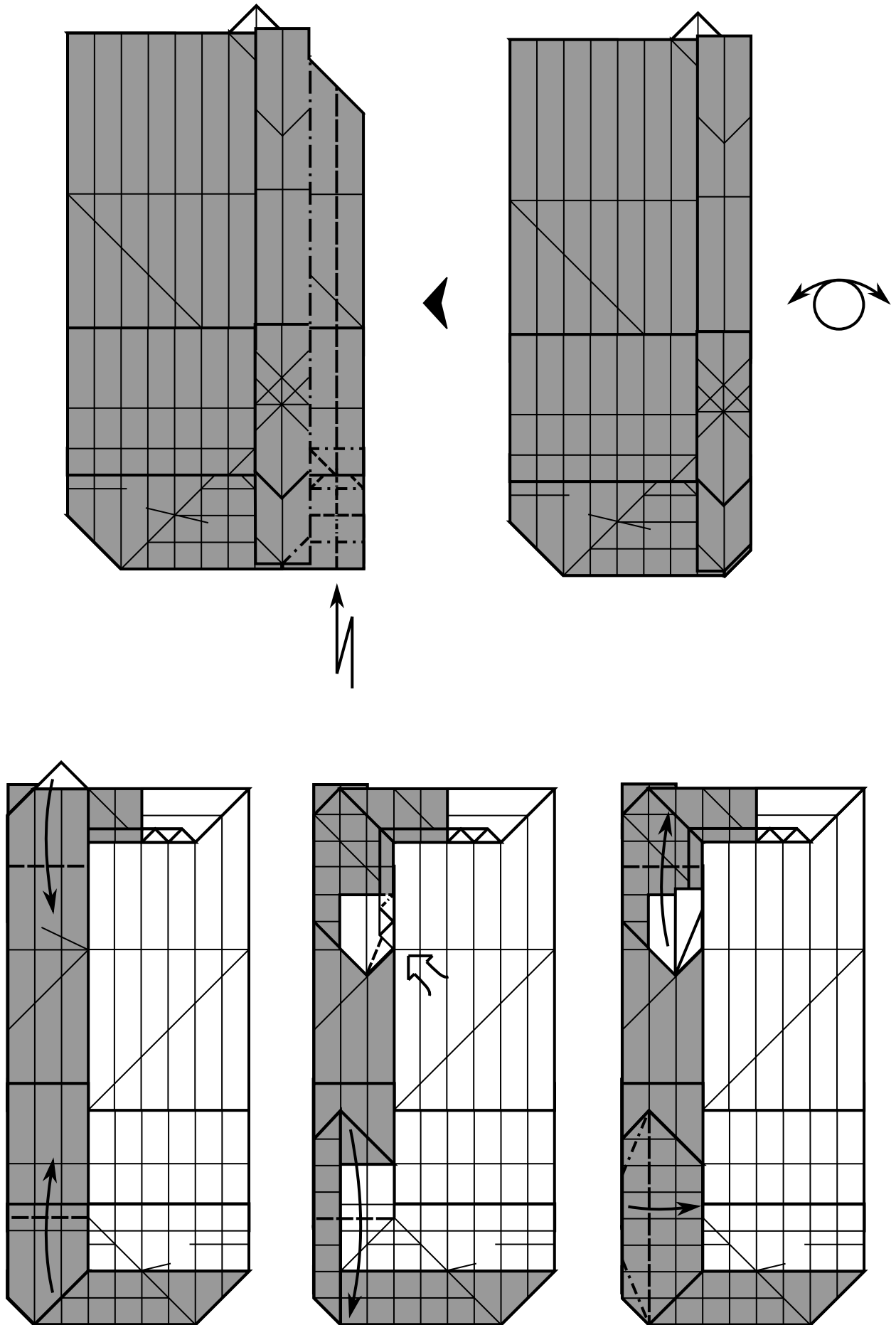

# The Bases of Folding

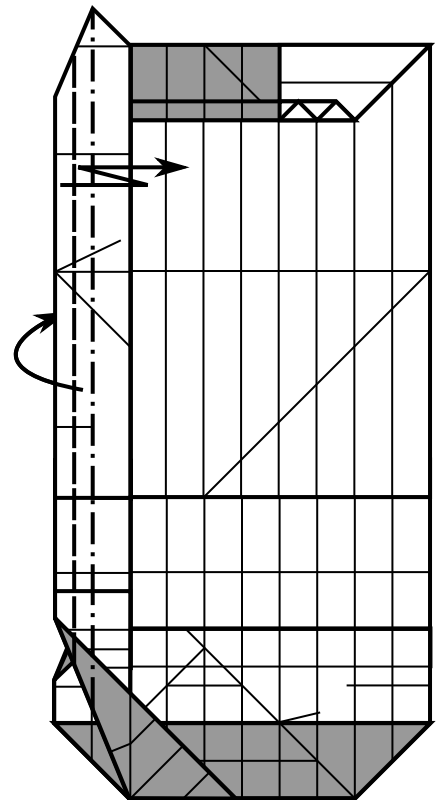
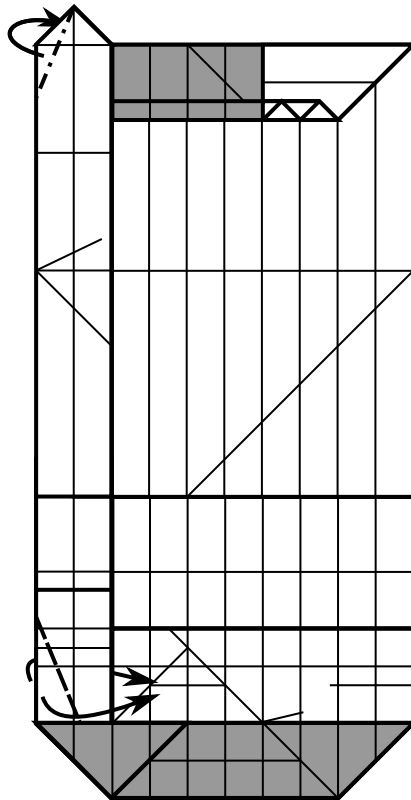
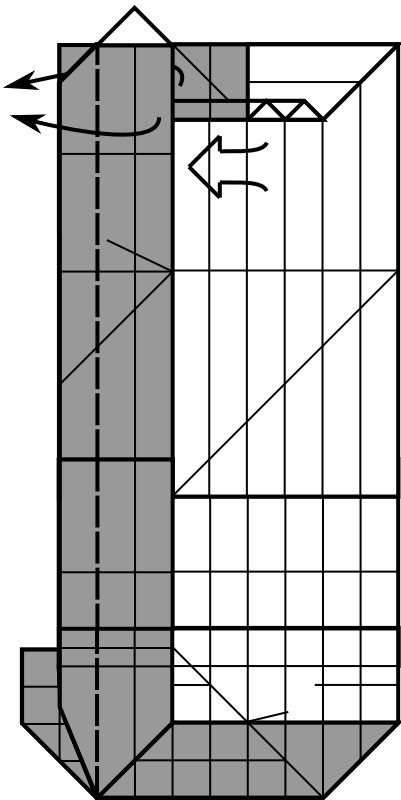
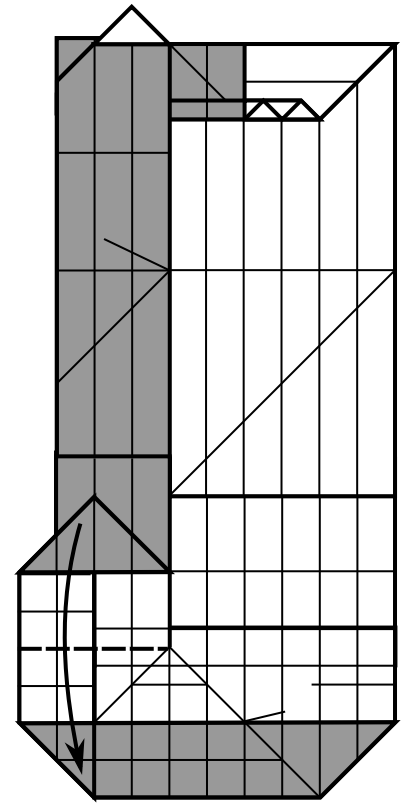
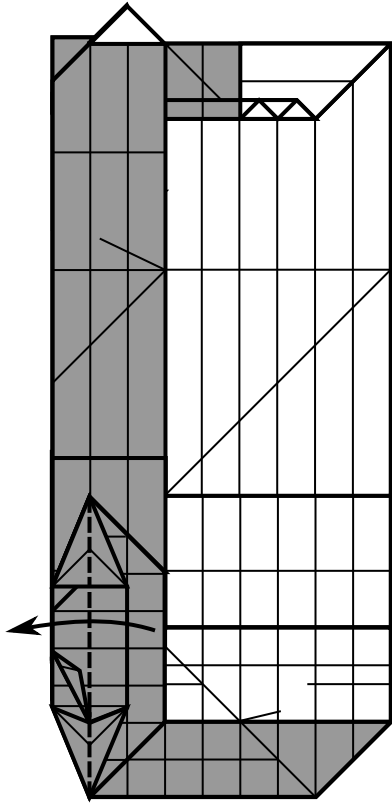
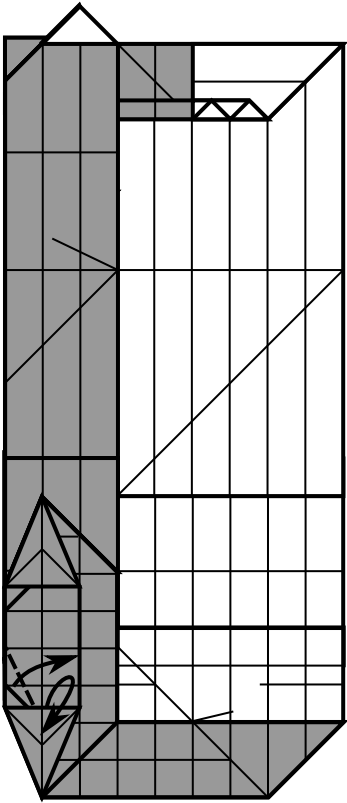



# The Bases of Folding

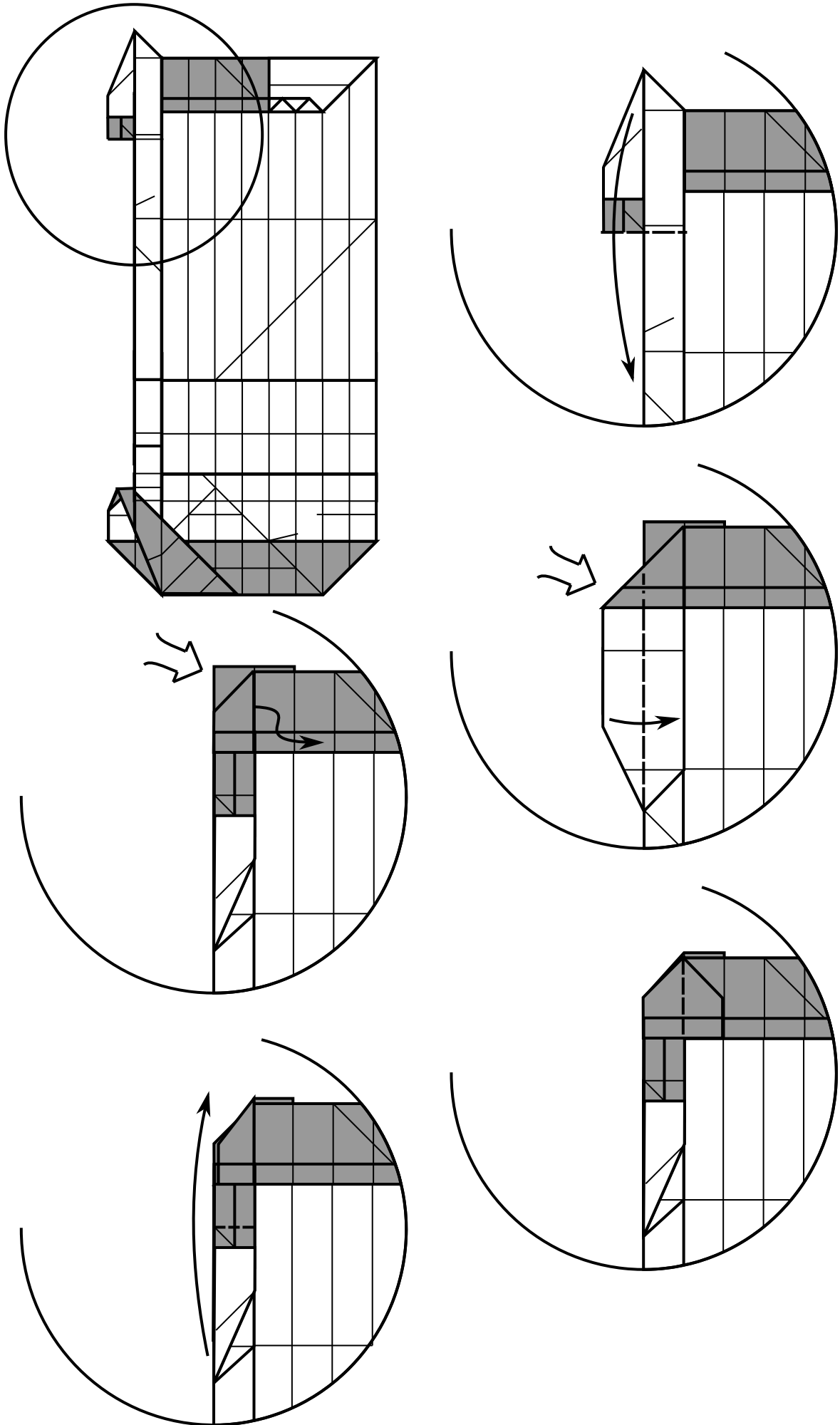

# The Bases of Folding

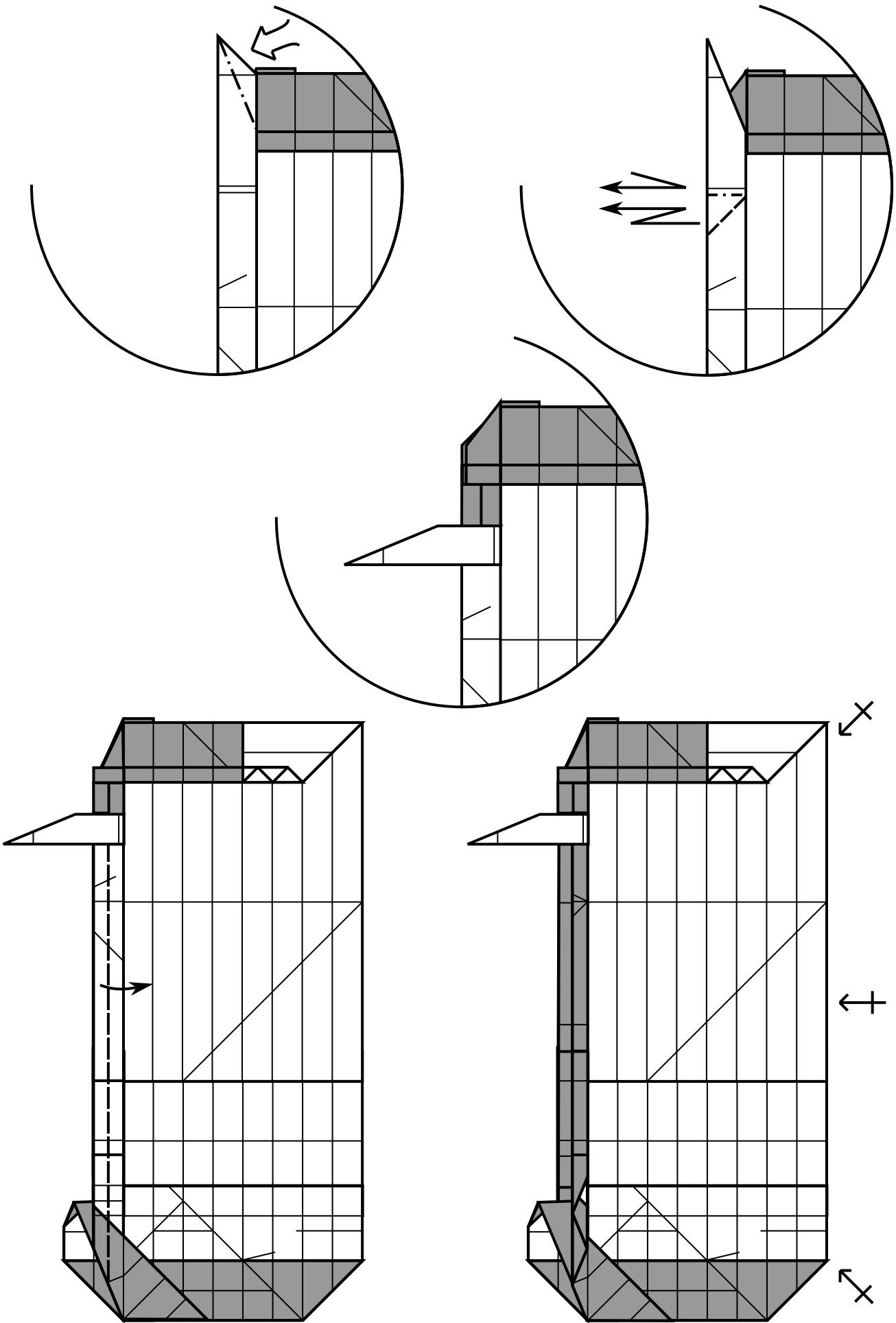

The Bases of Folding

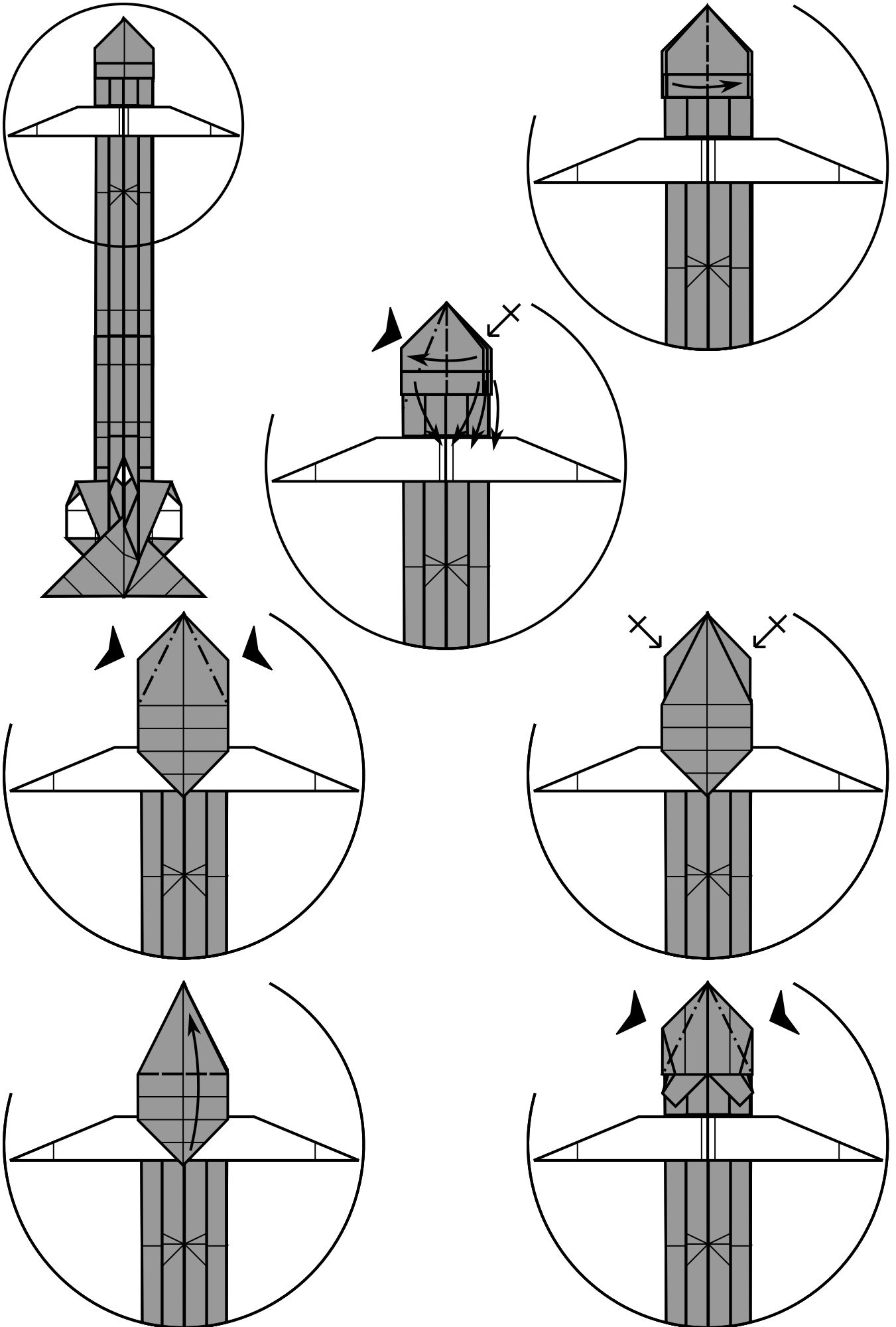

The Bases of Folding

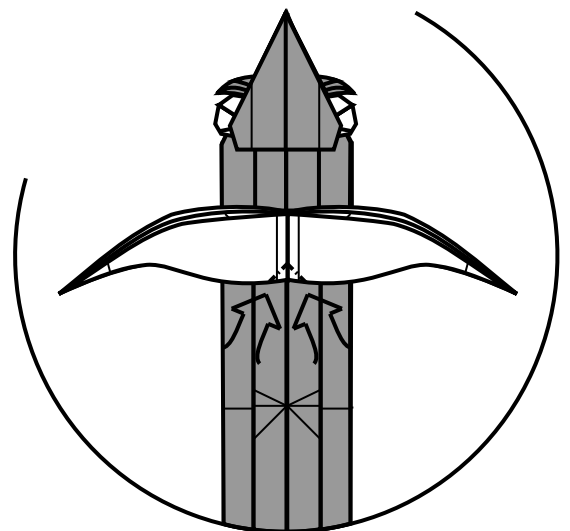
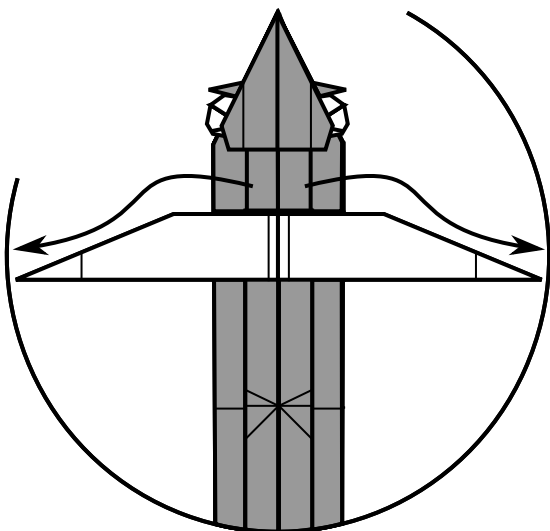
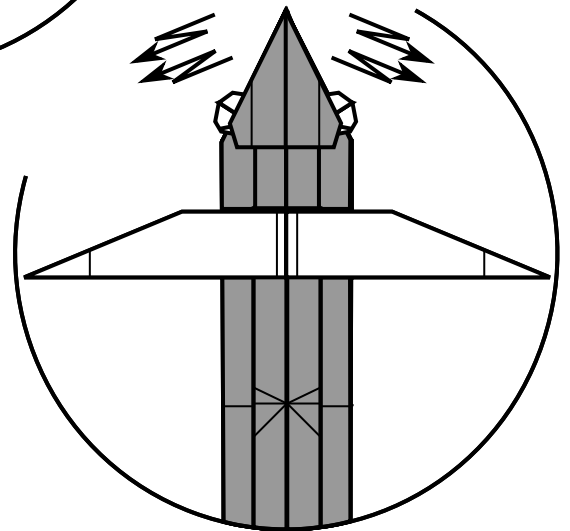
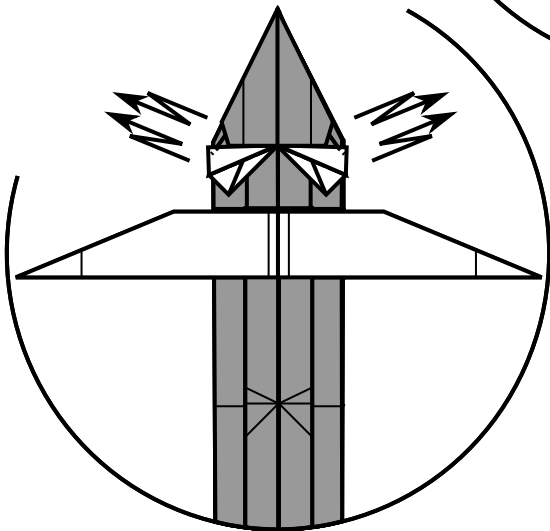
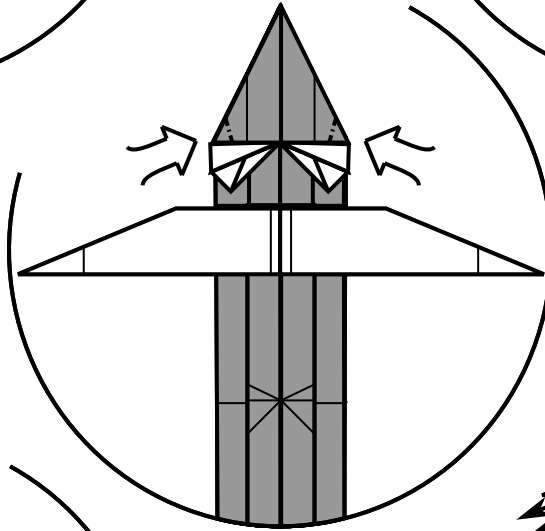
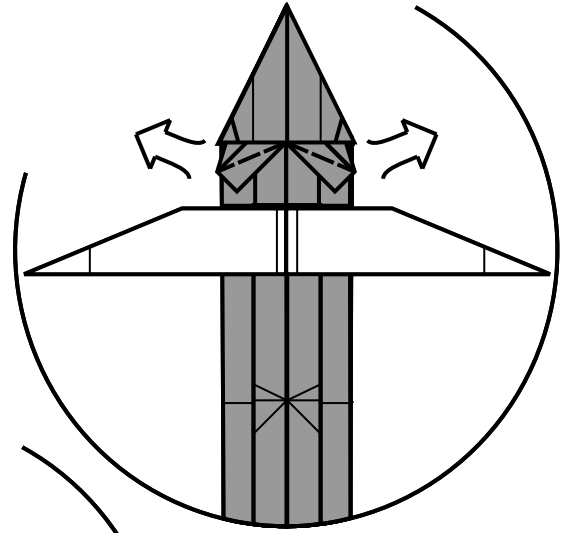
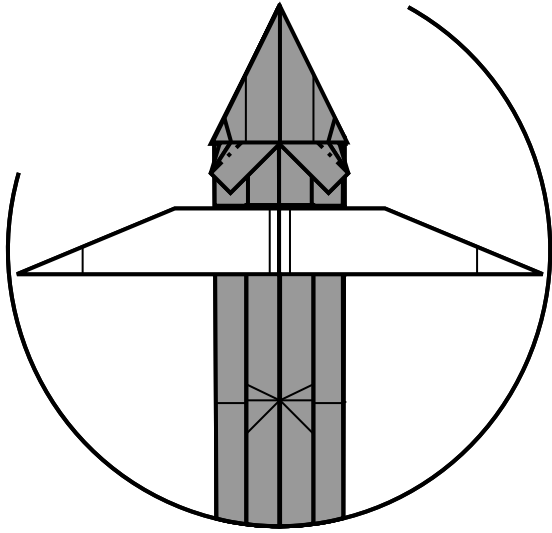

The Bases of Folding

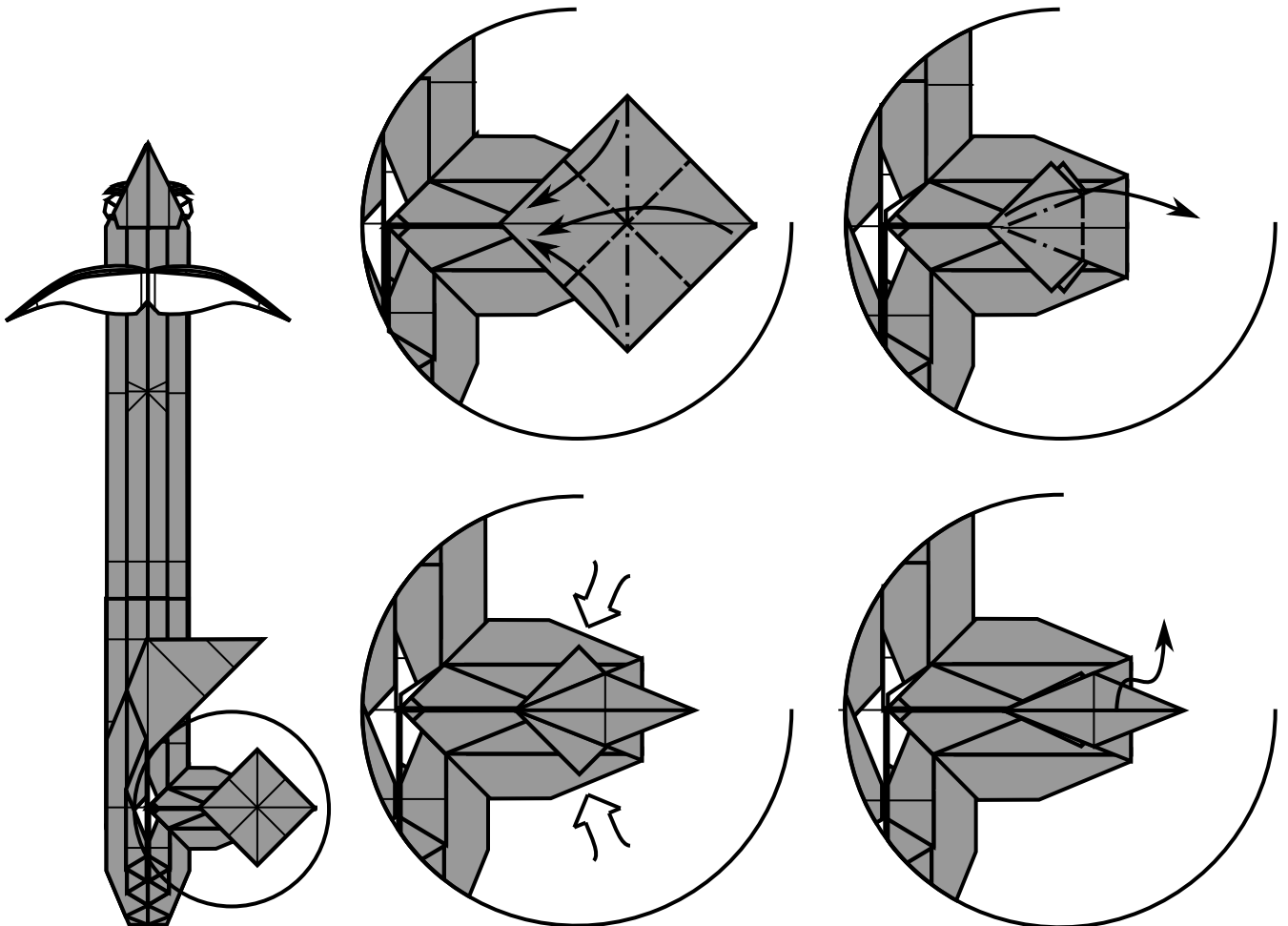
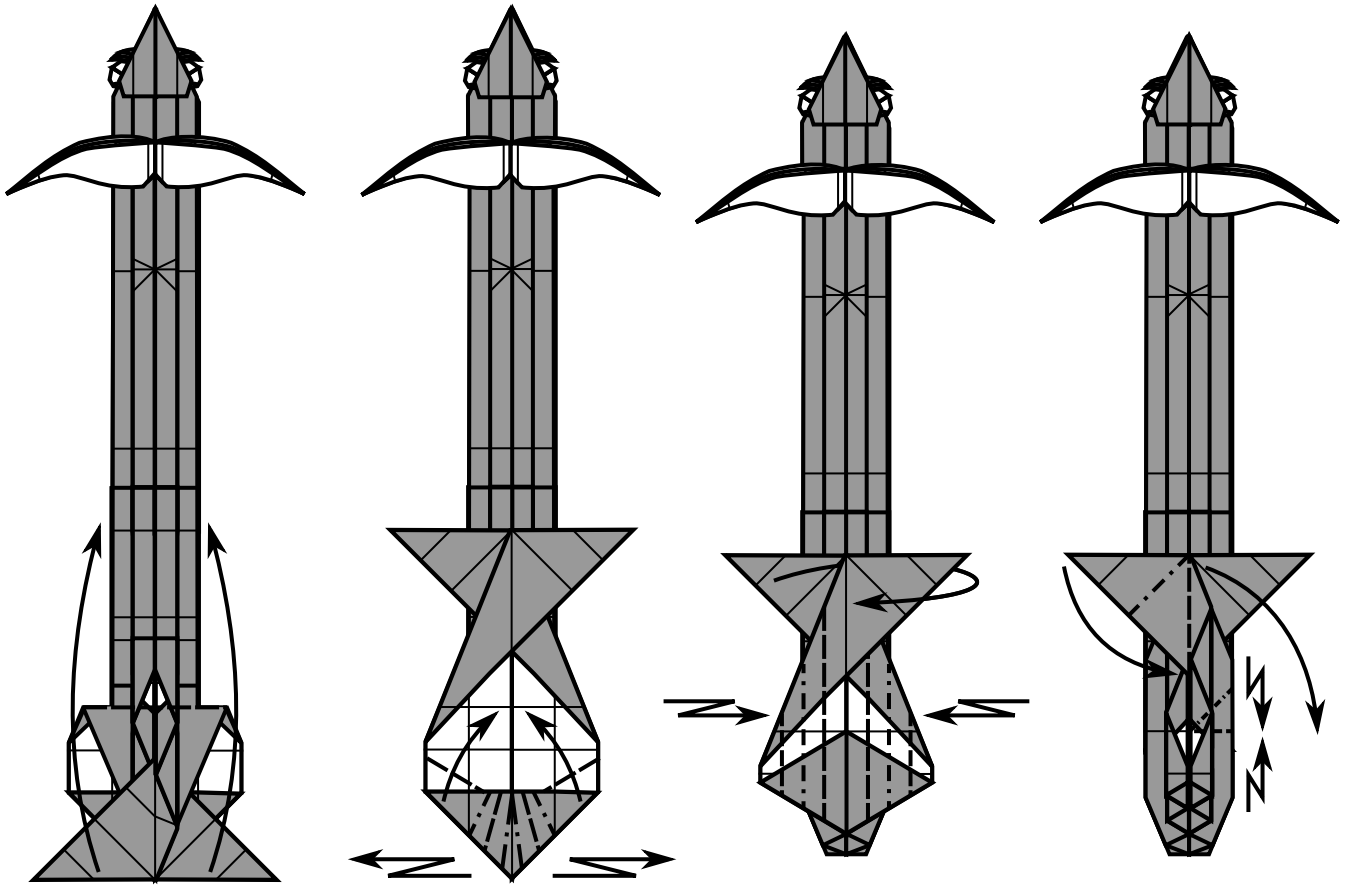

# The Bases of Folding

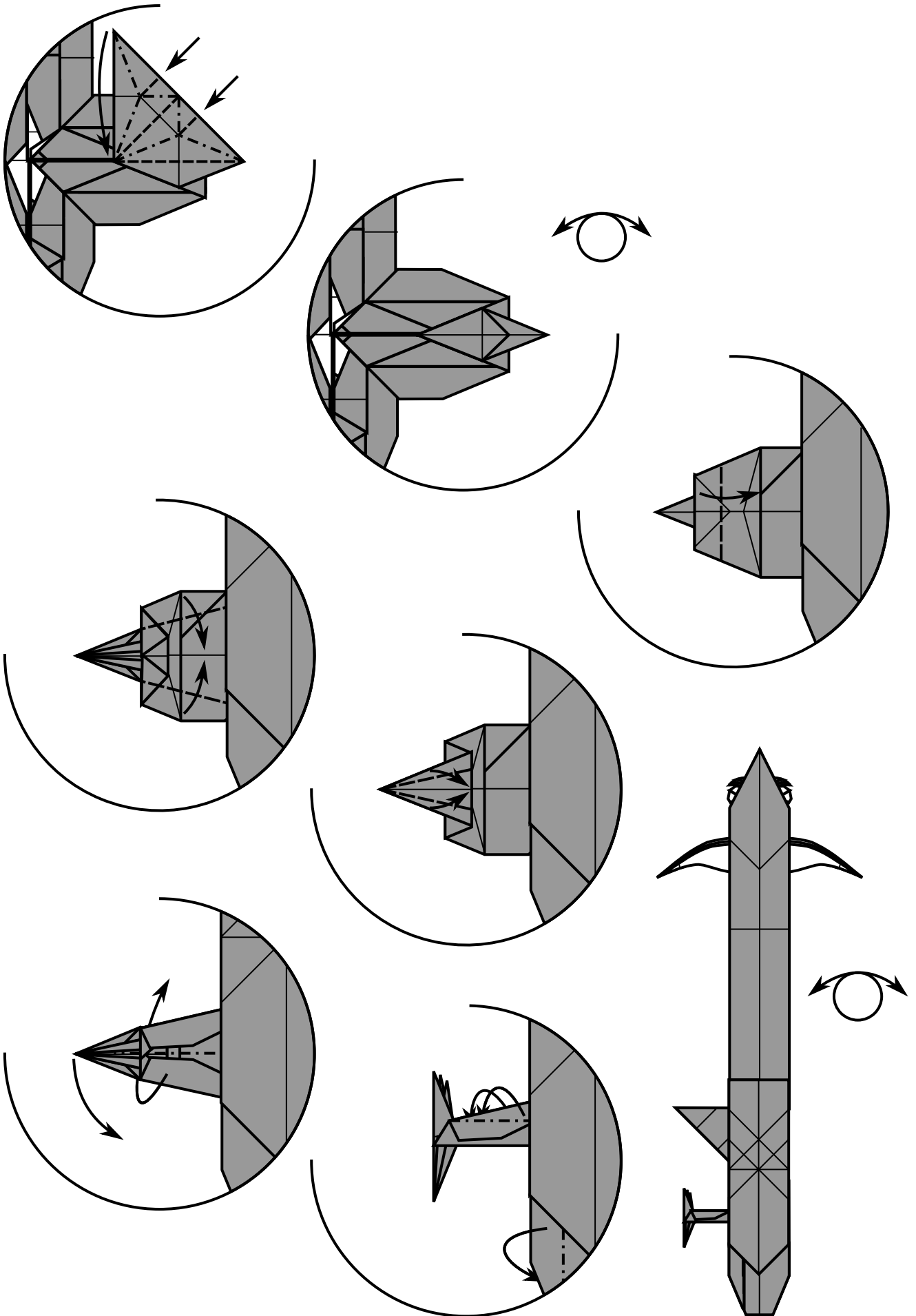

The Bases of Folding

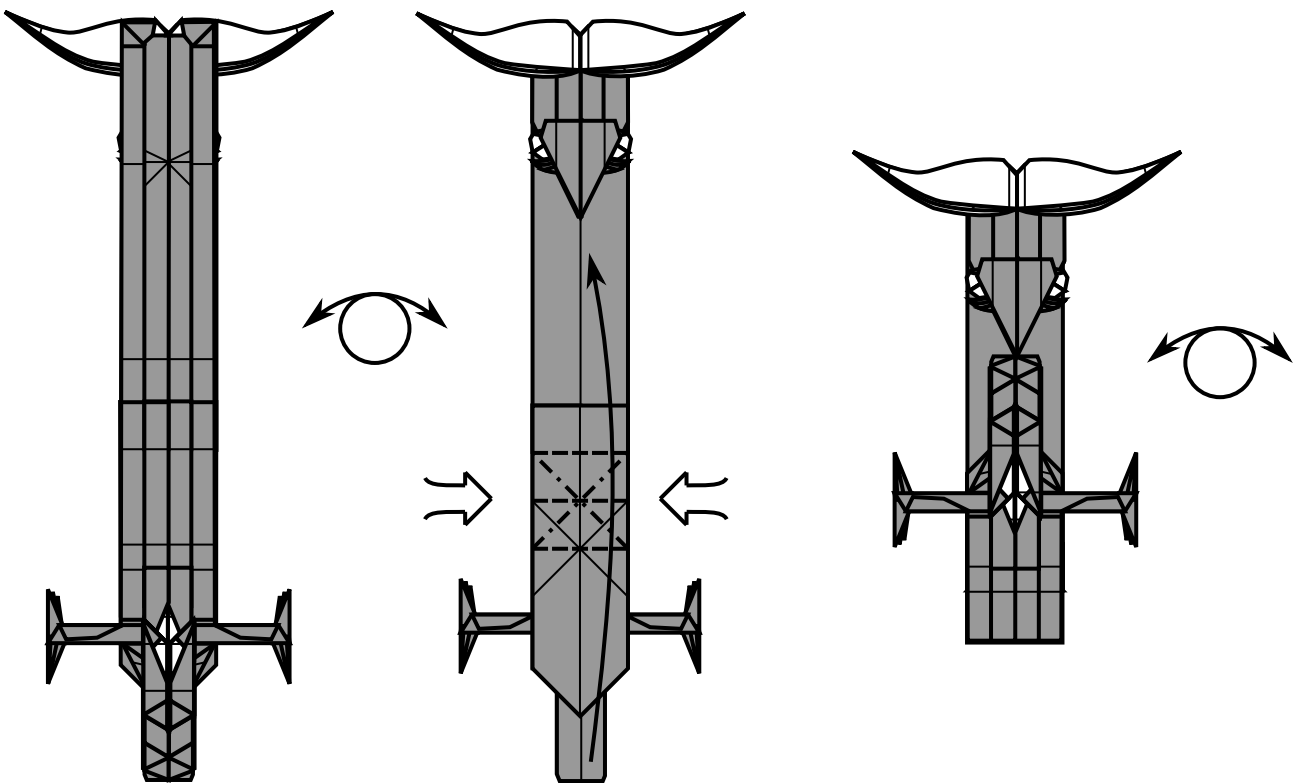
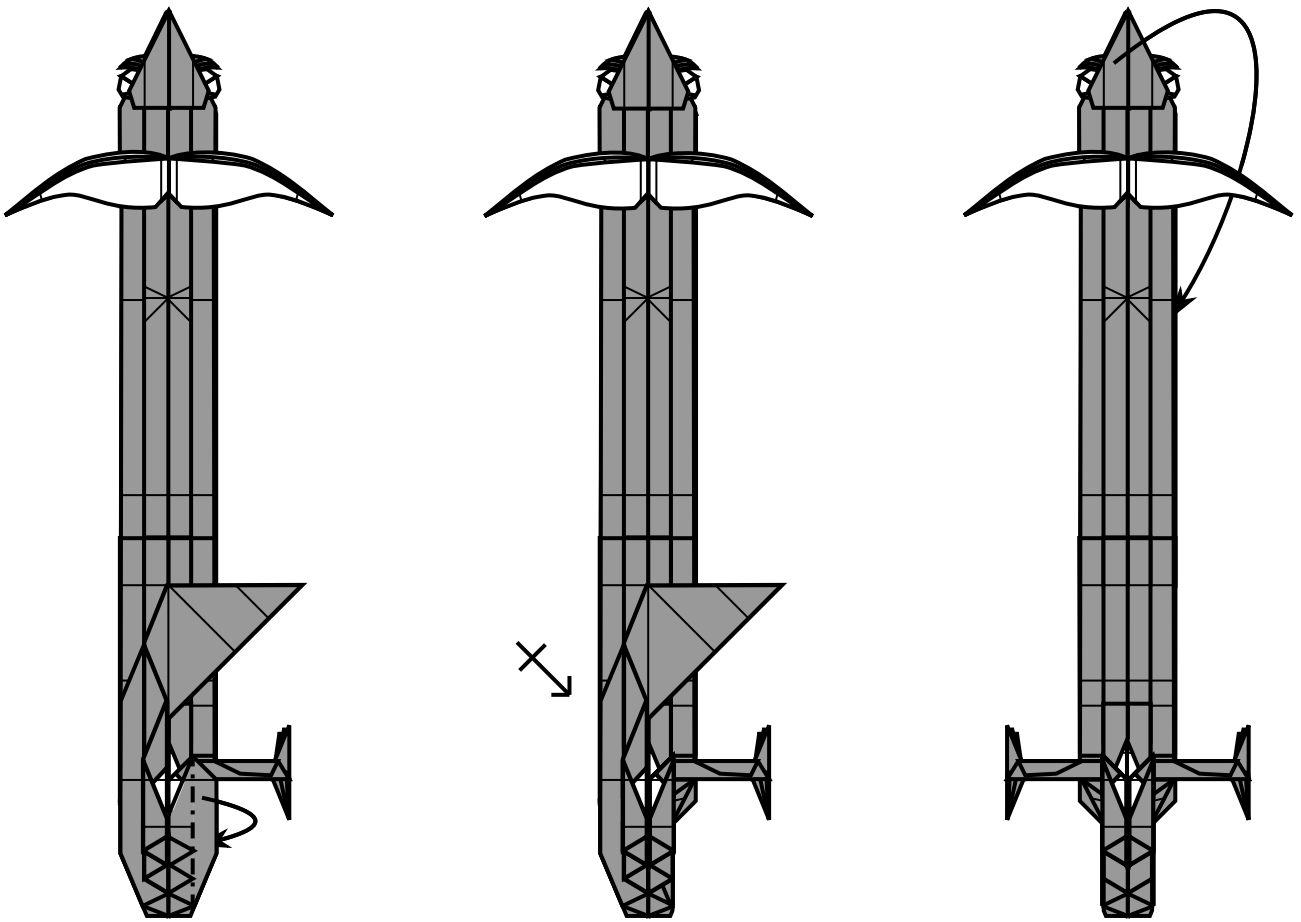

# The Bases of Folding

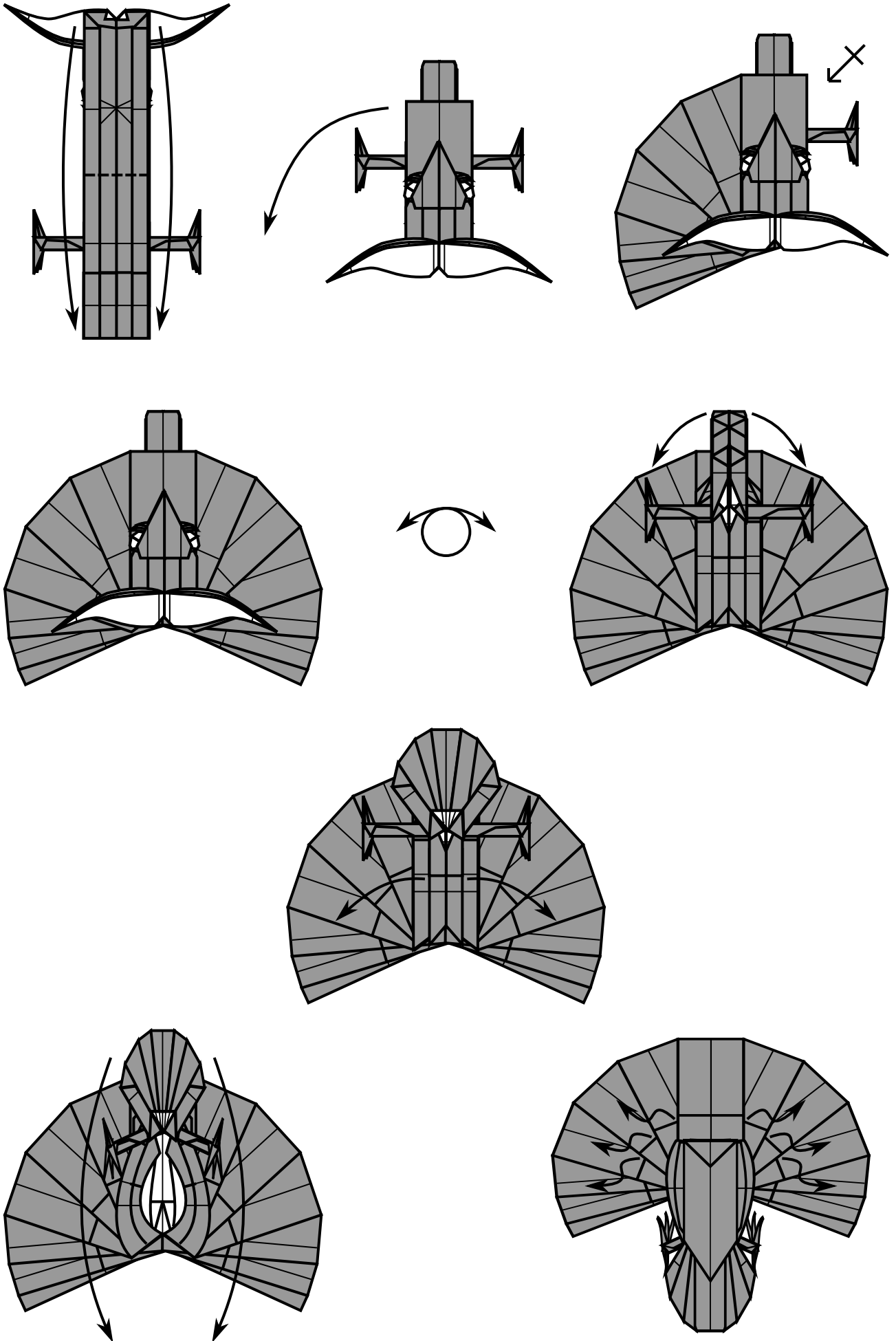



# The Bases of Folding

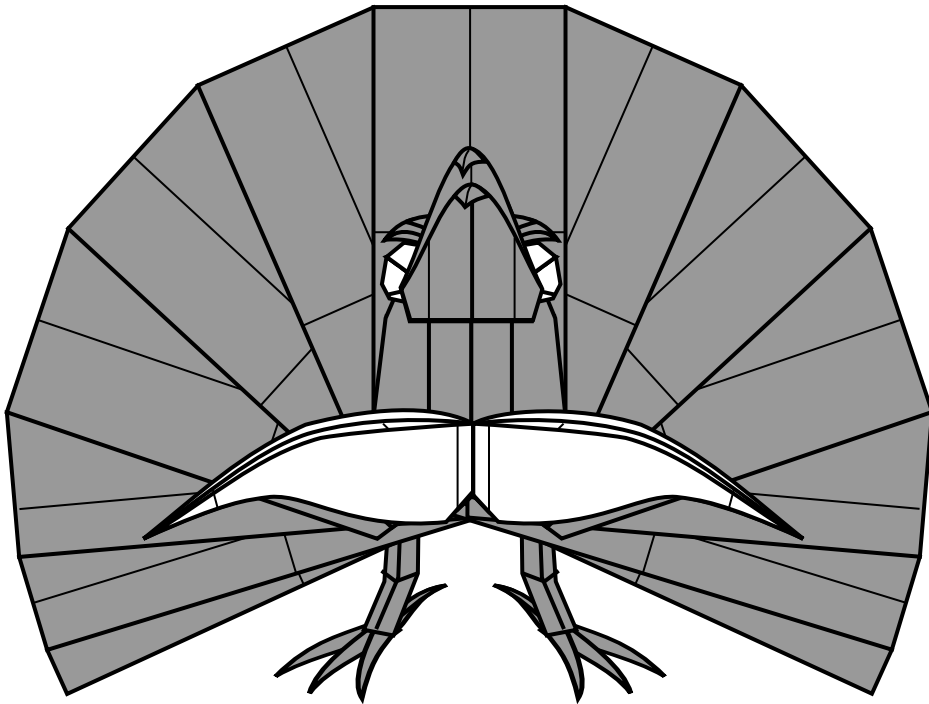
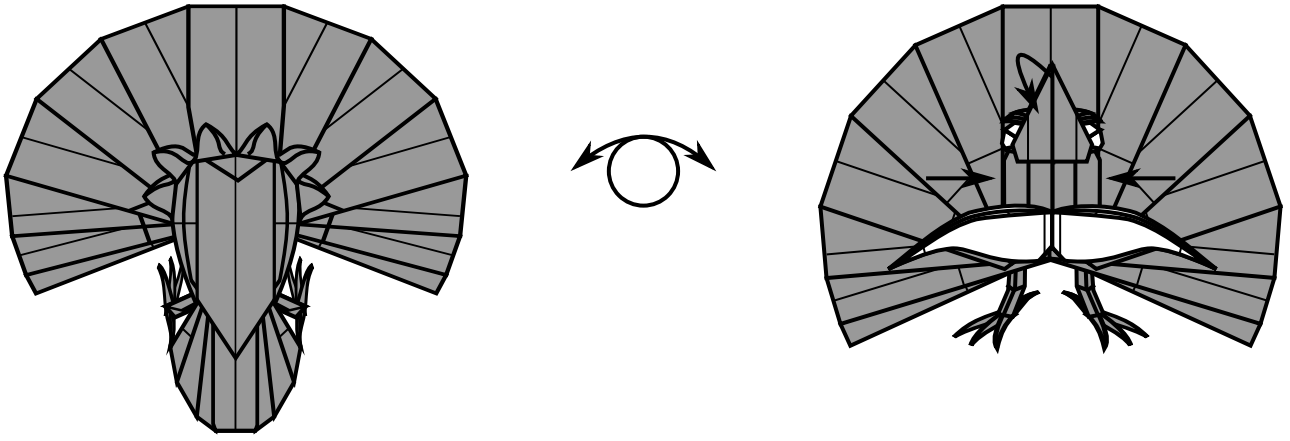

# Bacteriophage

This model, unlike everything thus far, is not an animal. In fact, it's still disputed whether or not it is even alive. With both its mechanical structure and method of replication, the bacteriophage is more machine than anything else.

This is not a traditional diagram, rather a step by step of the crease pattern. It seems rather fitting to have something more basic and technical for an existence such as this.

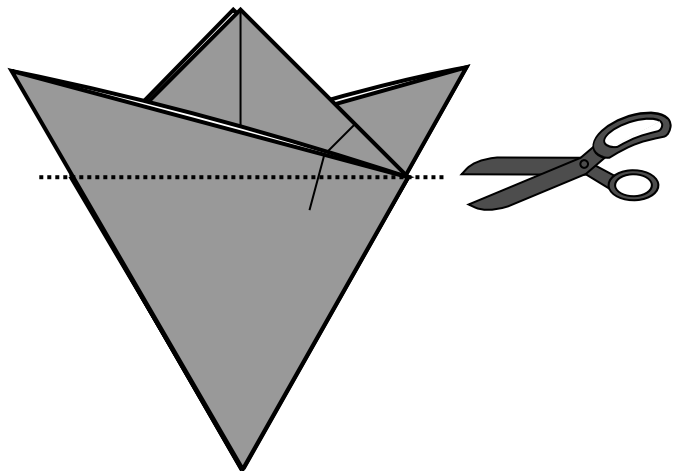
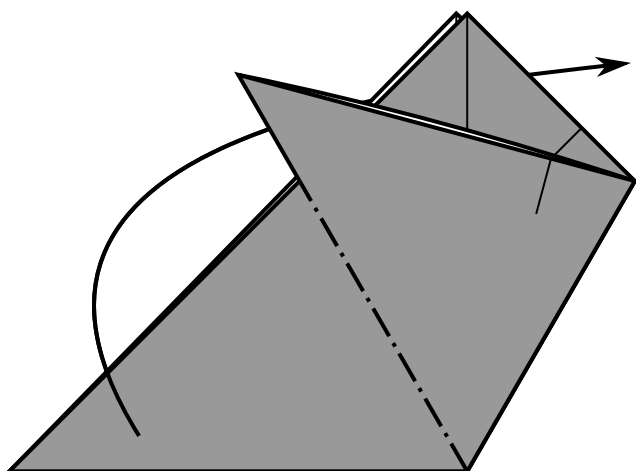
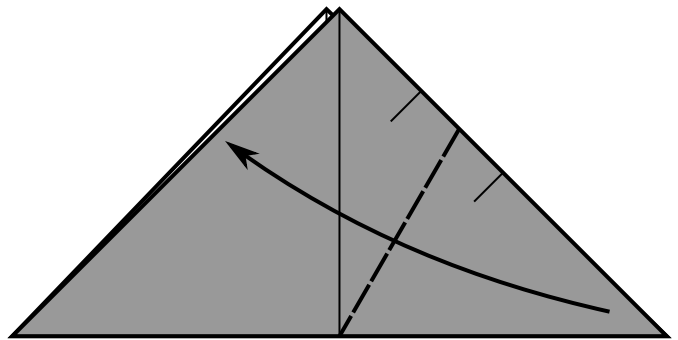
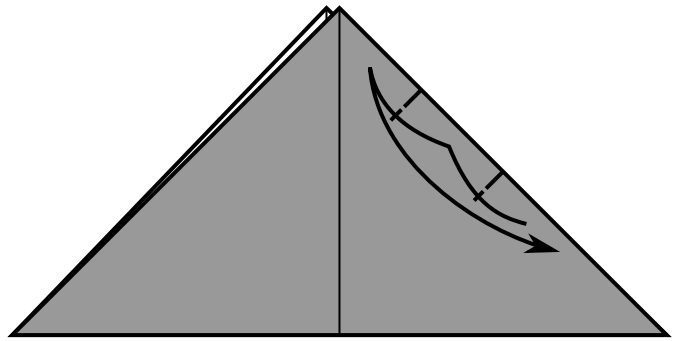
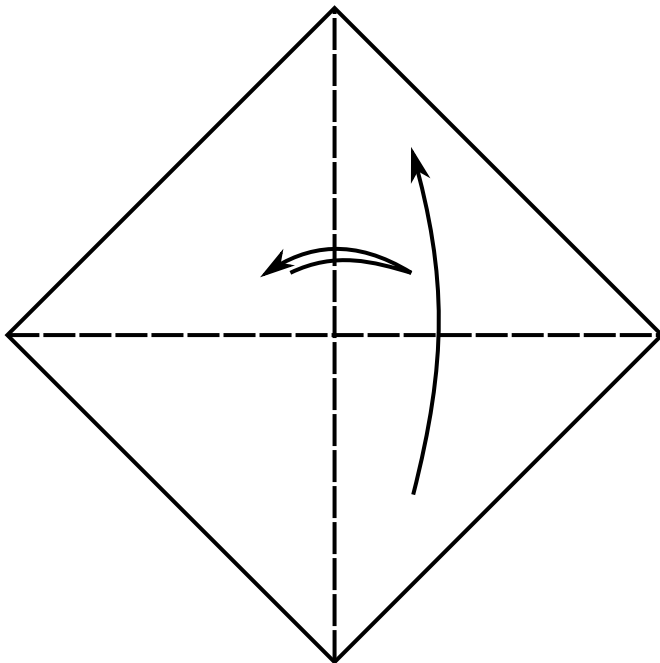

# The Bases of Folding

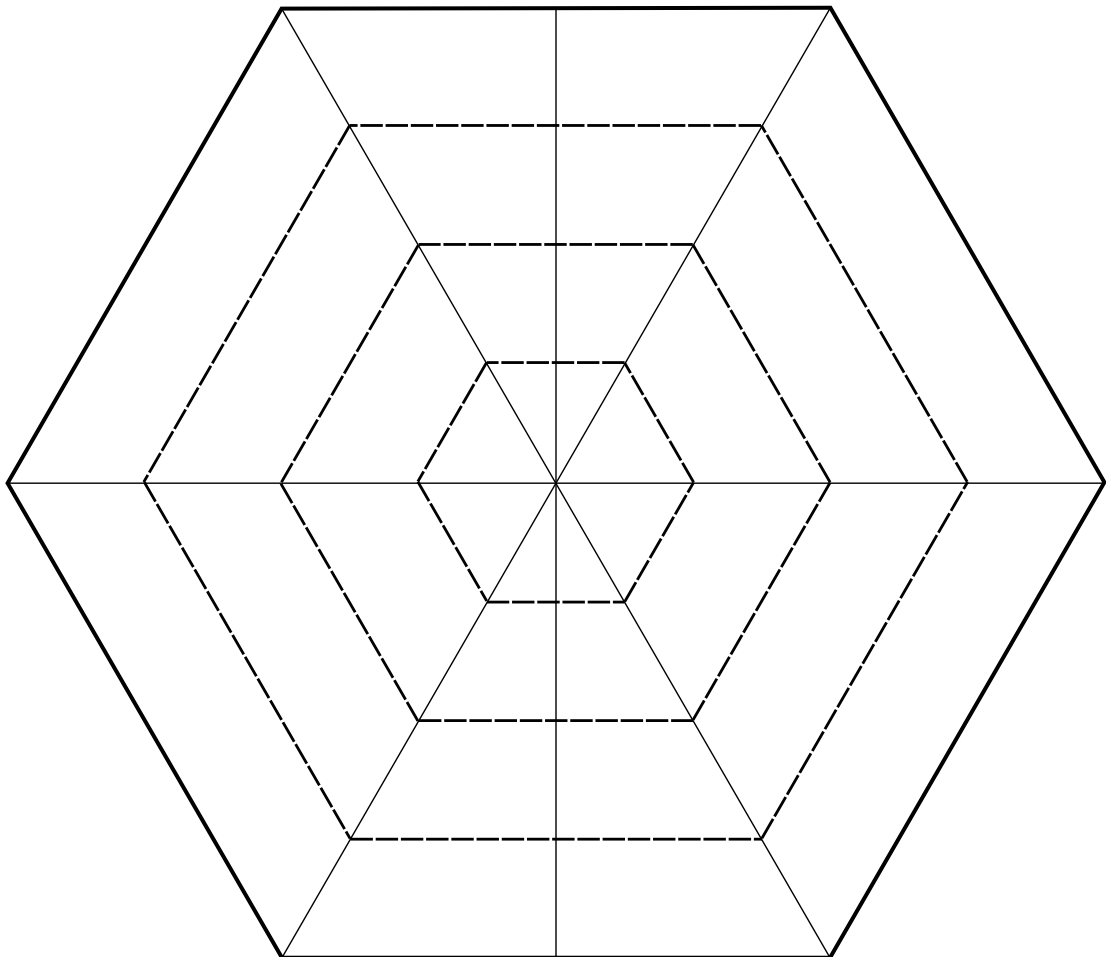
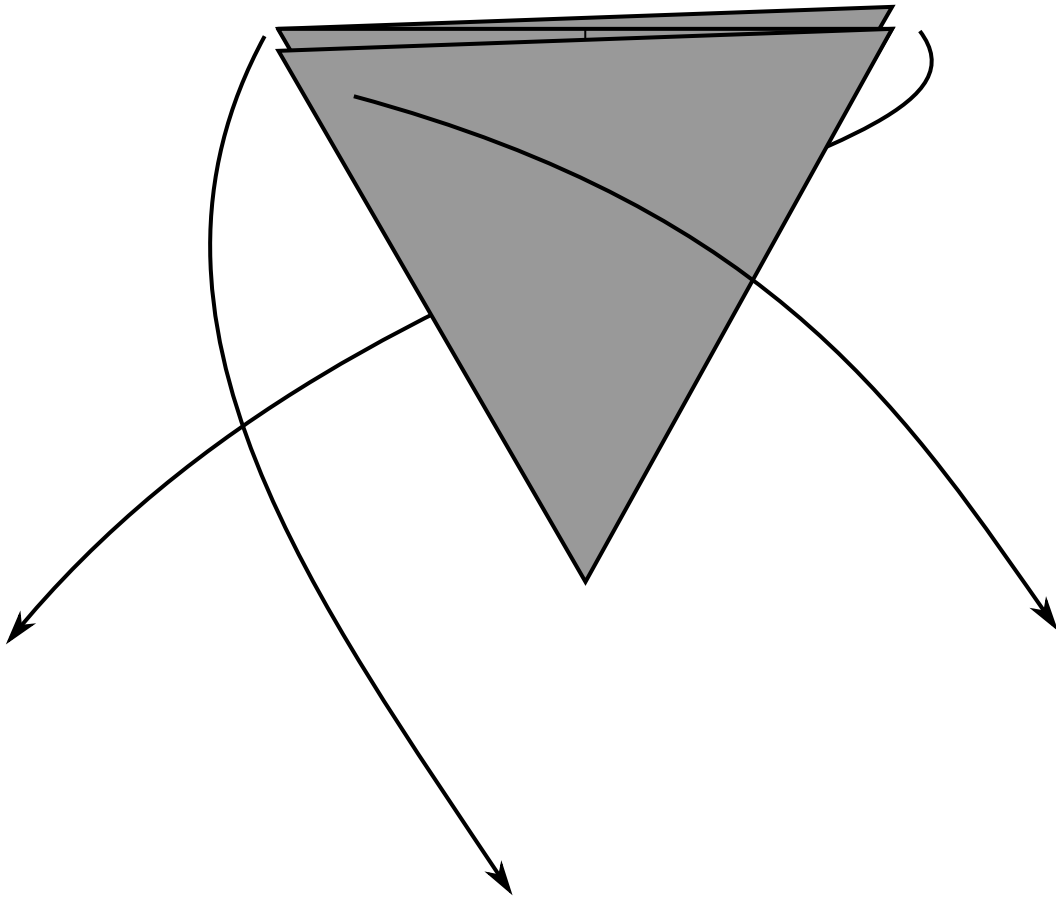

# The Bases of Folding

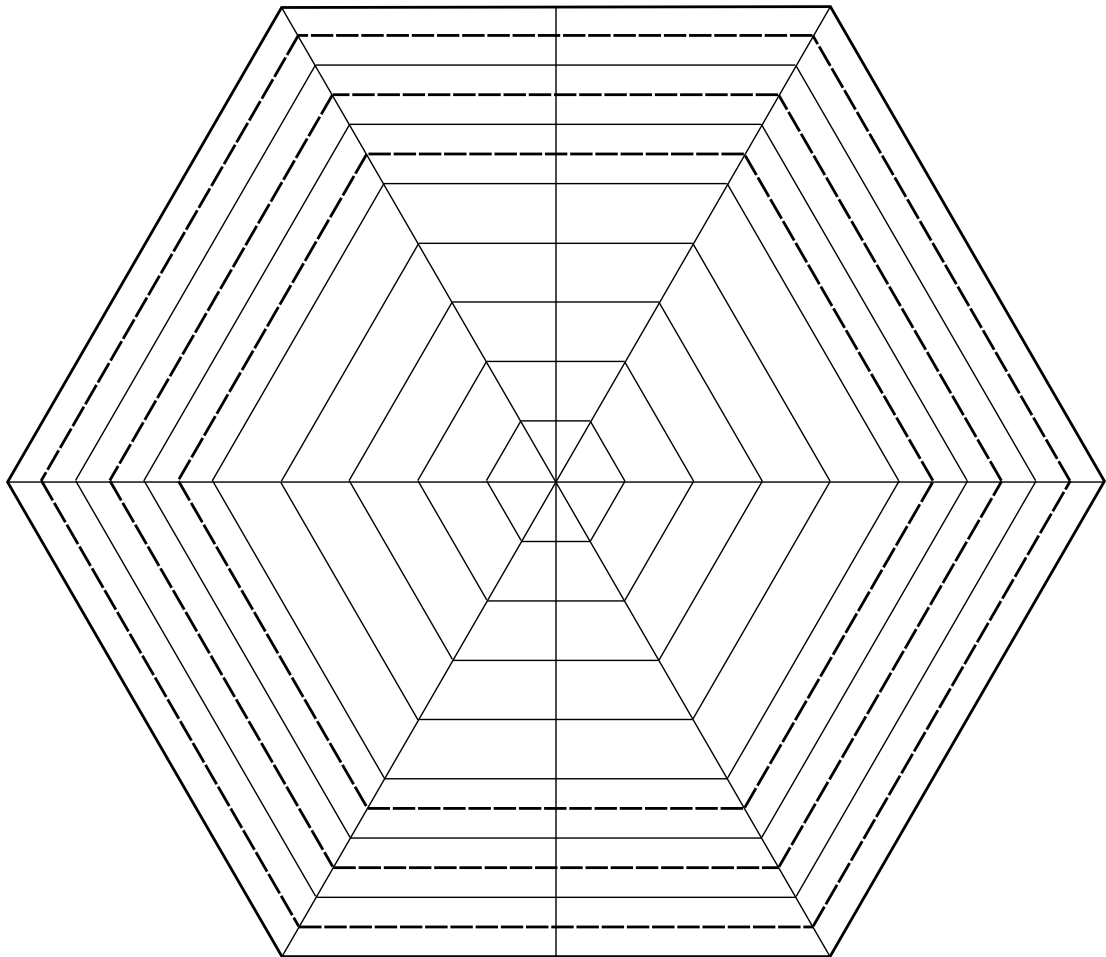
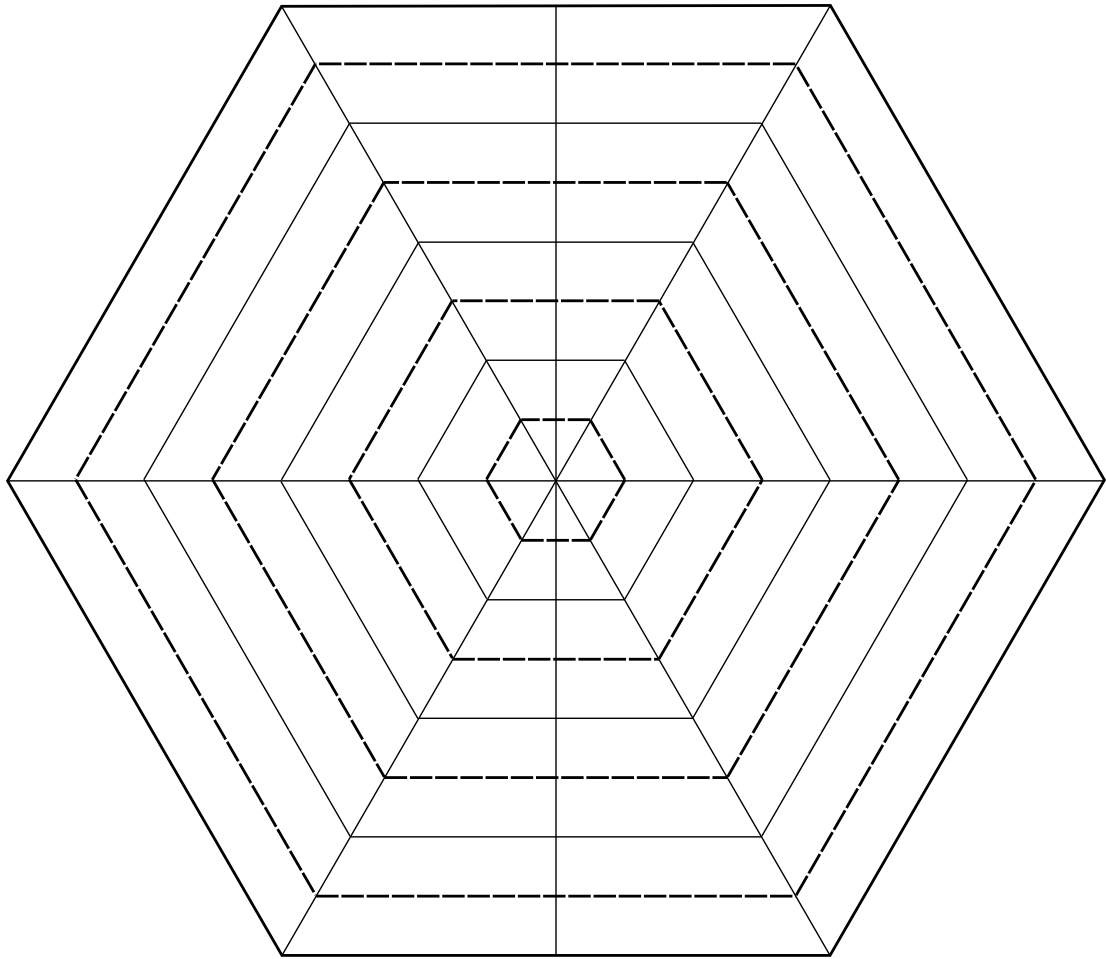

# The Bases of Folding

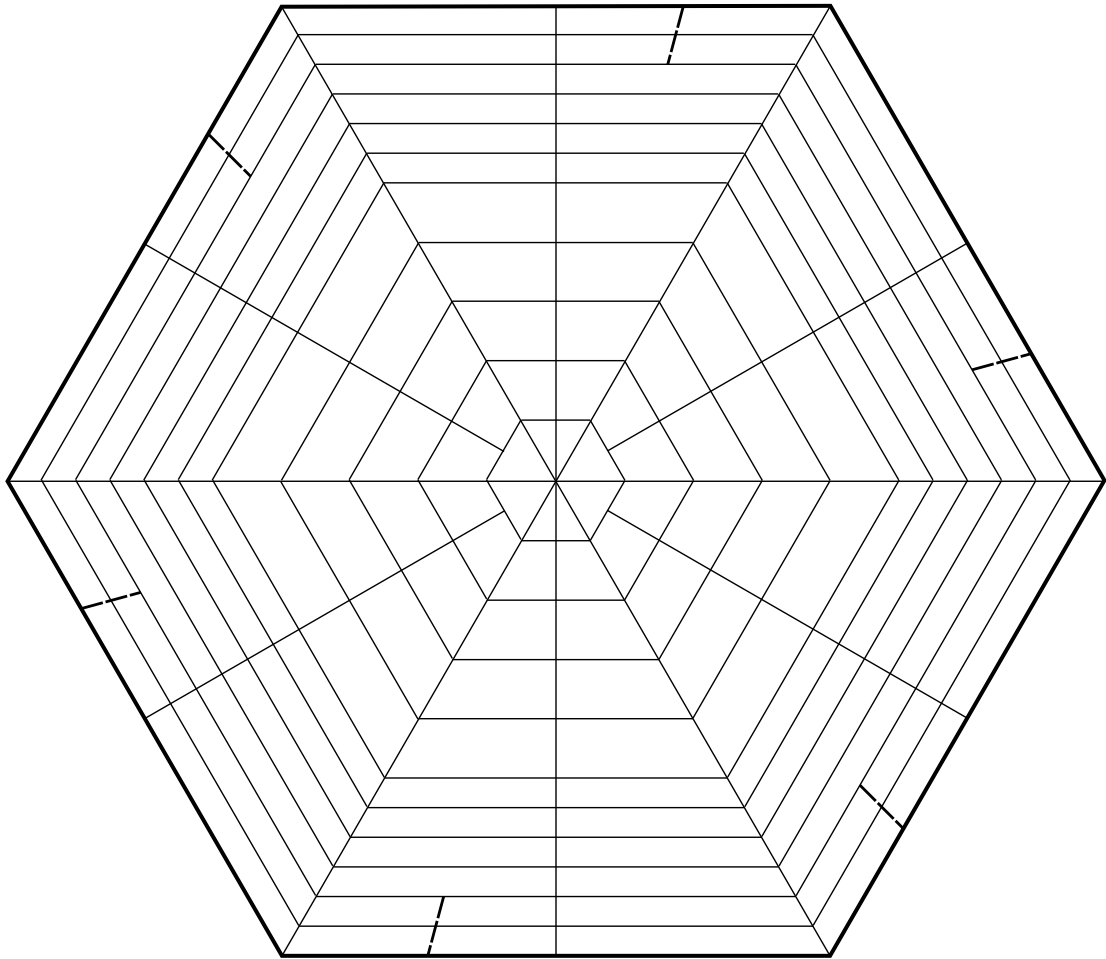
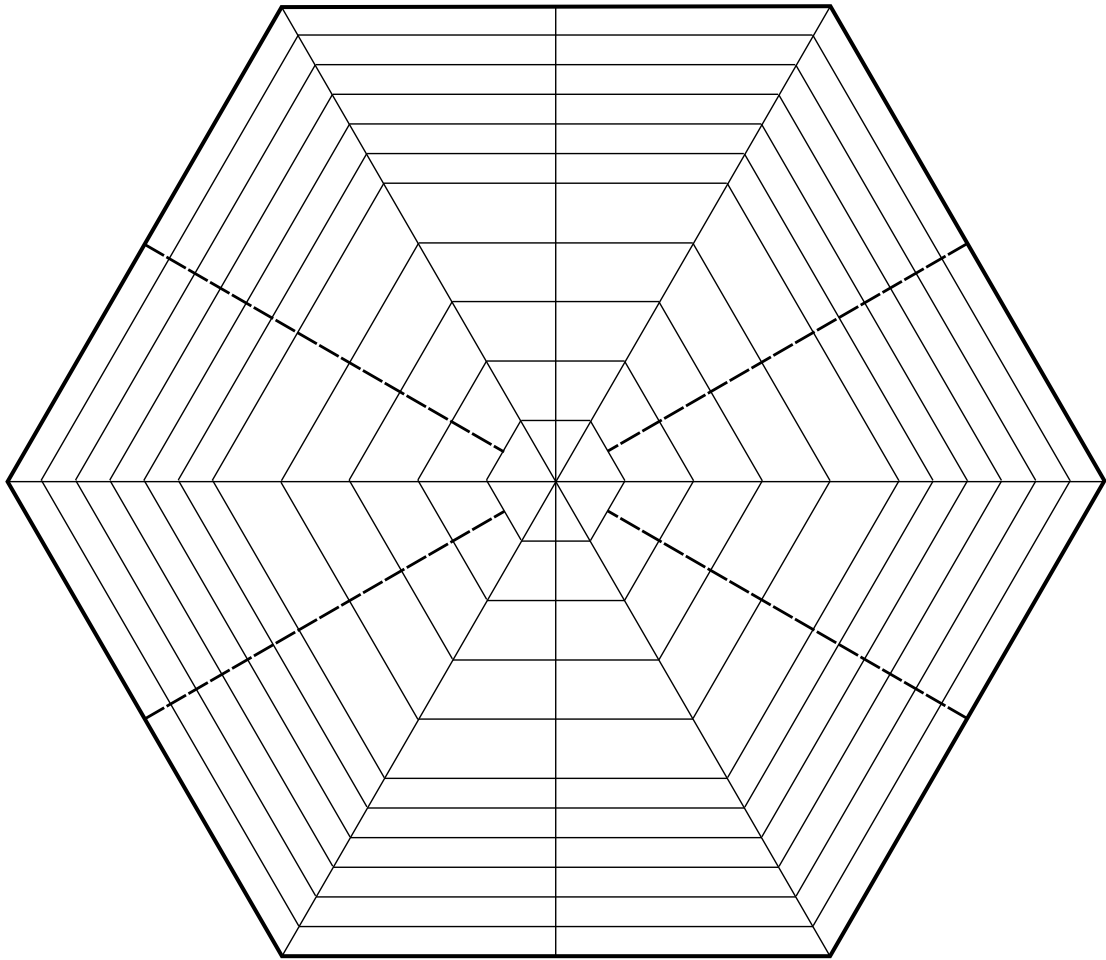

# The Bases of Folding

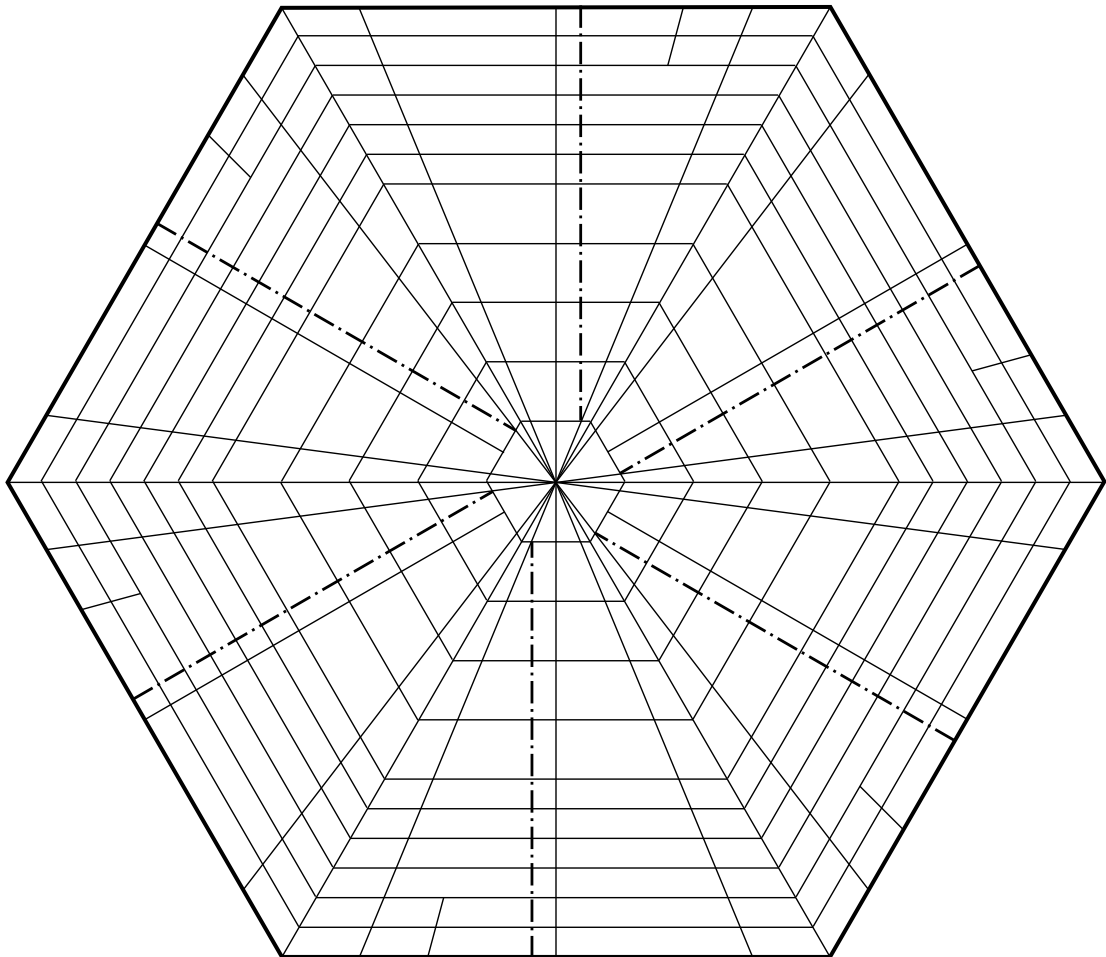
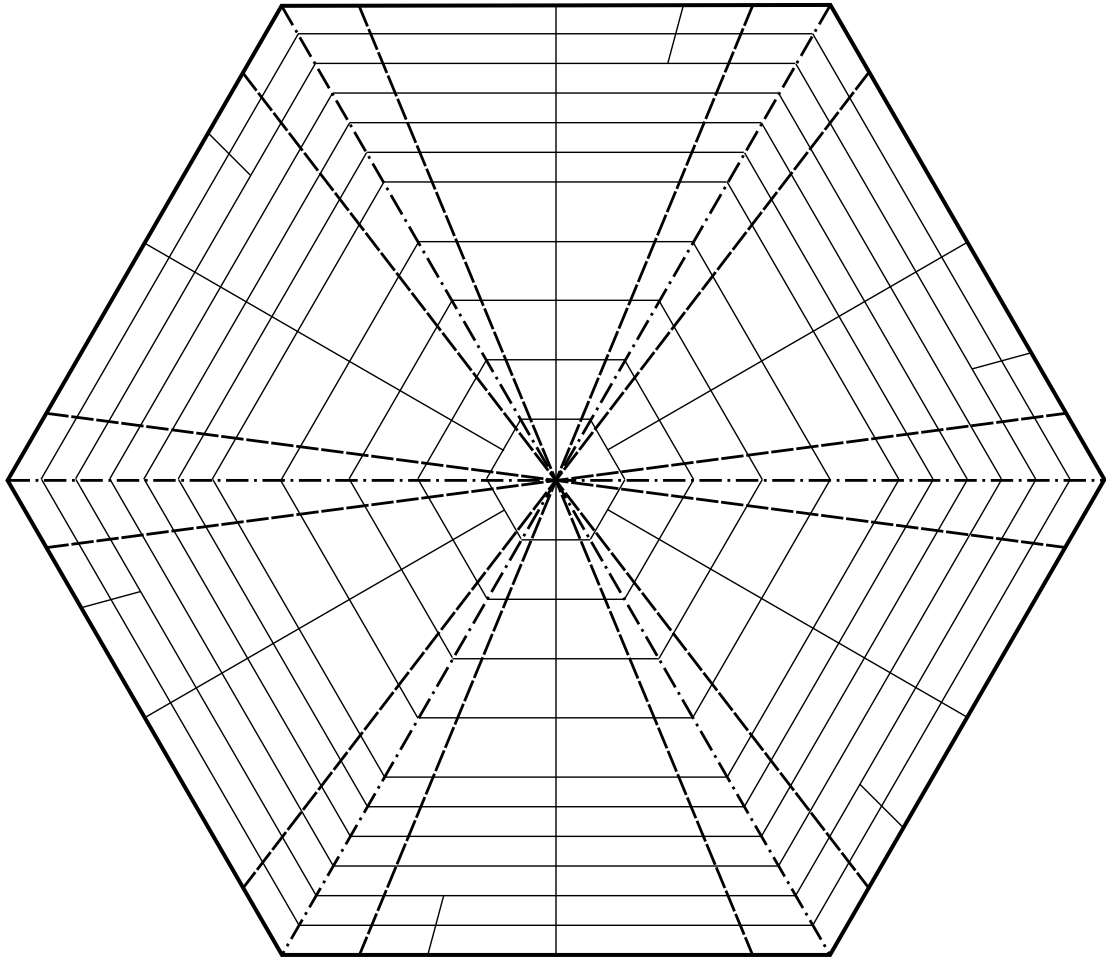

# The Bases of Folding

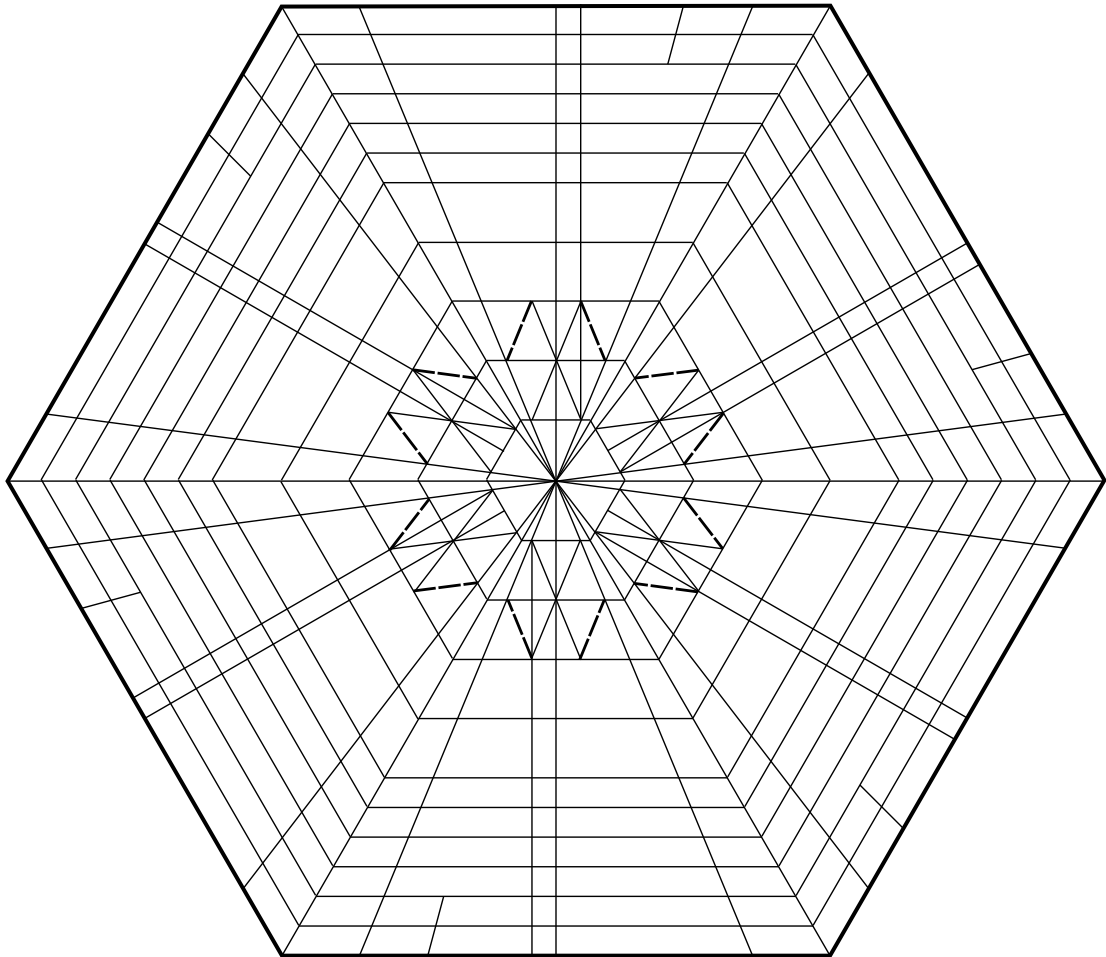
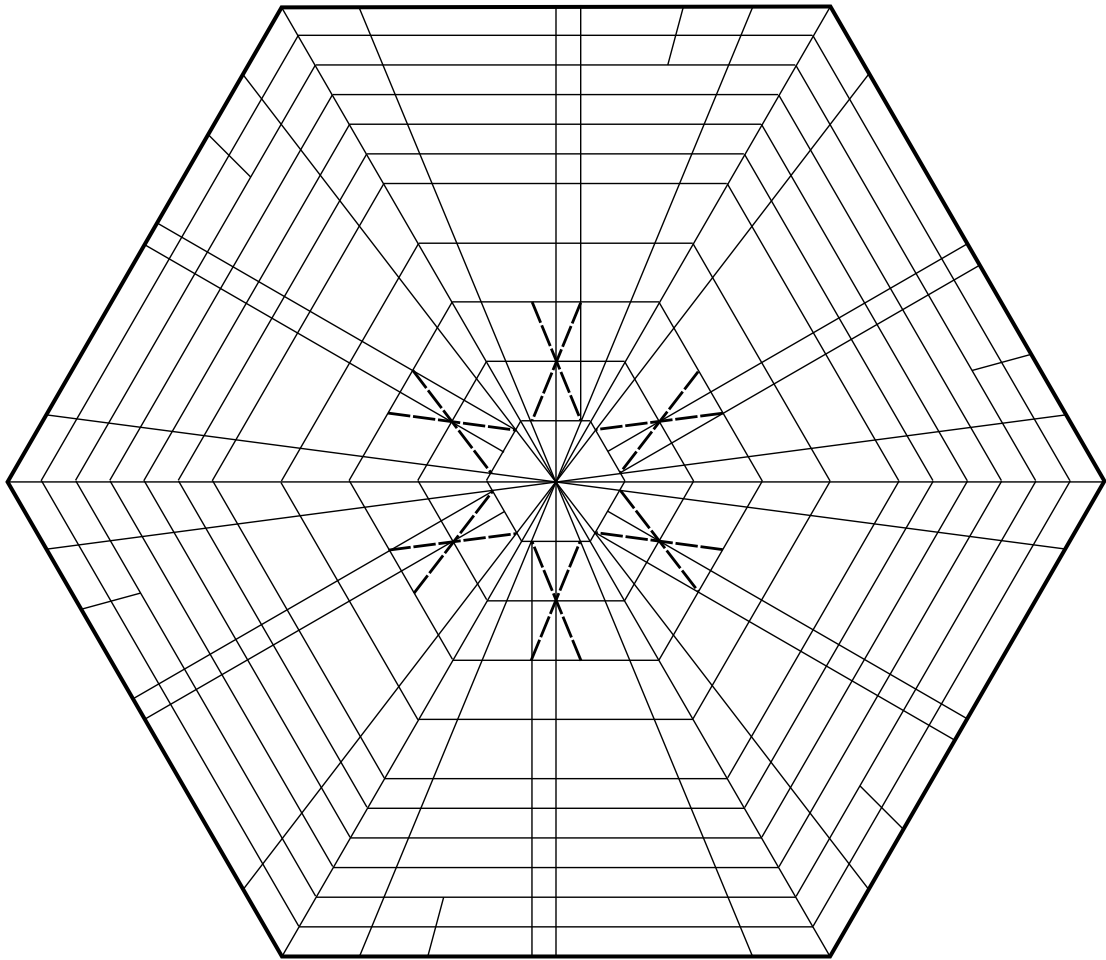

# The Bases of Folding

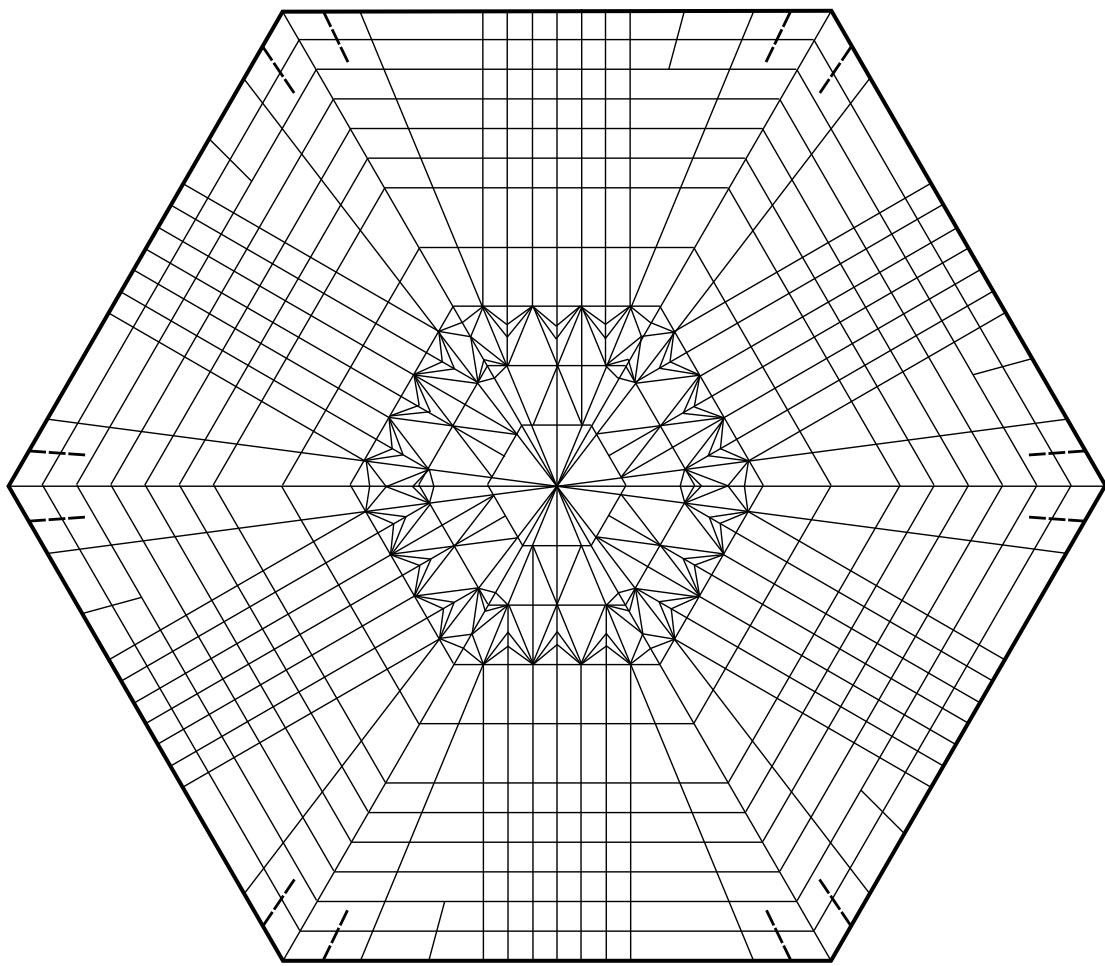
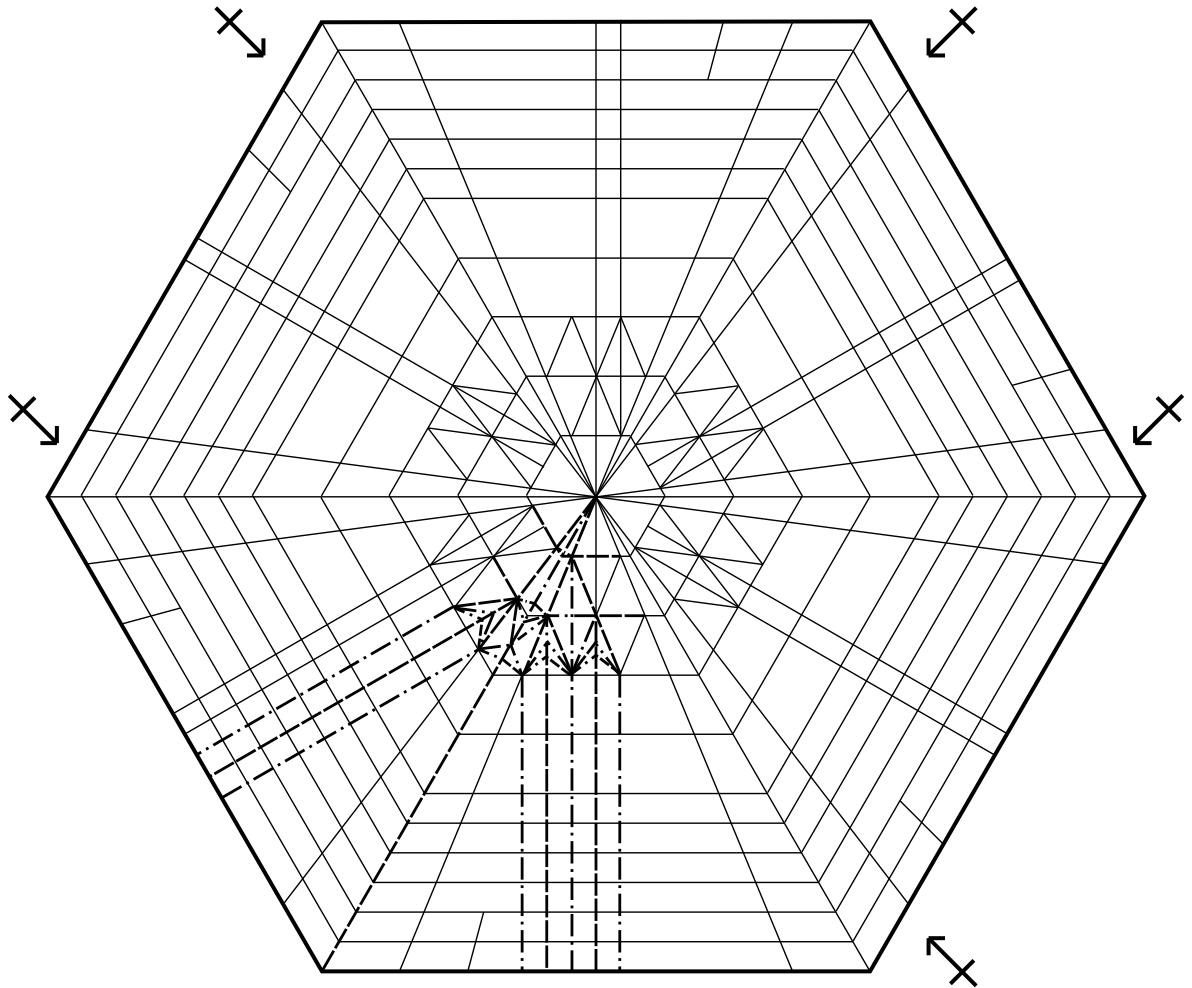



# The Bases of Folding

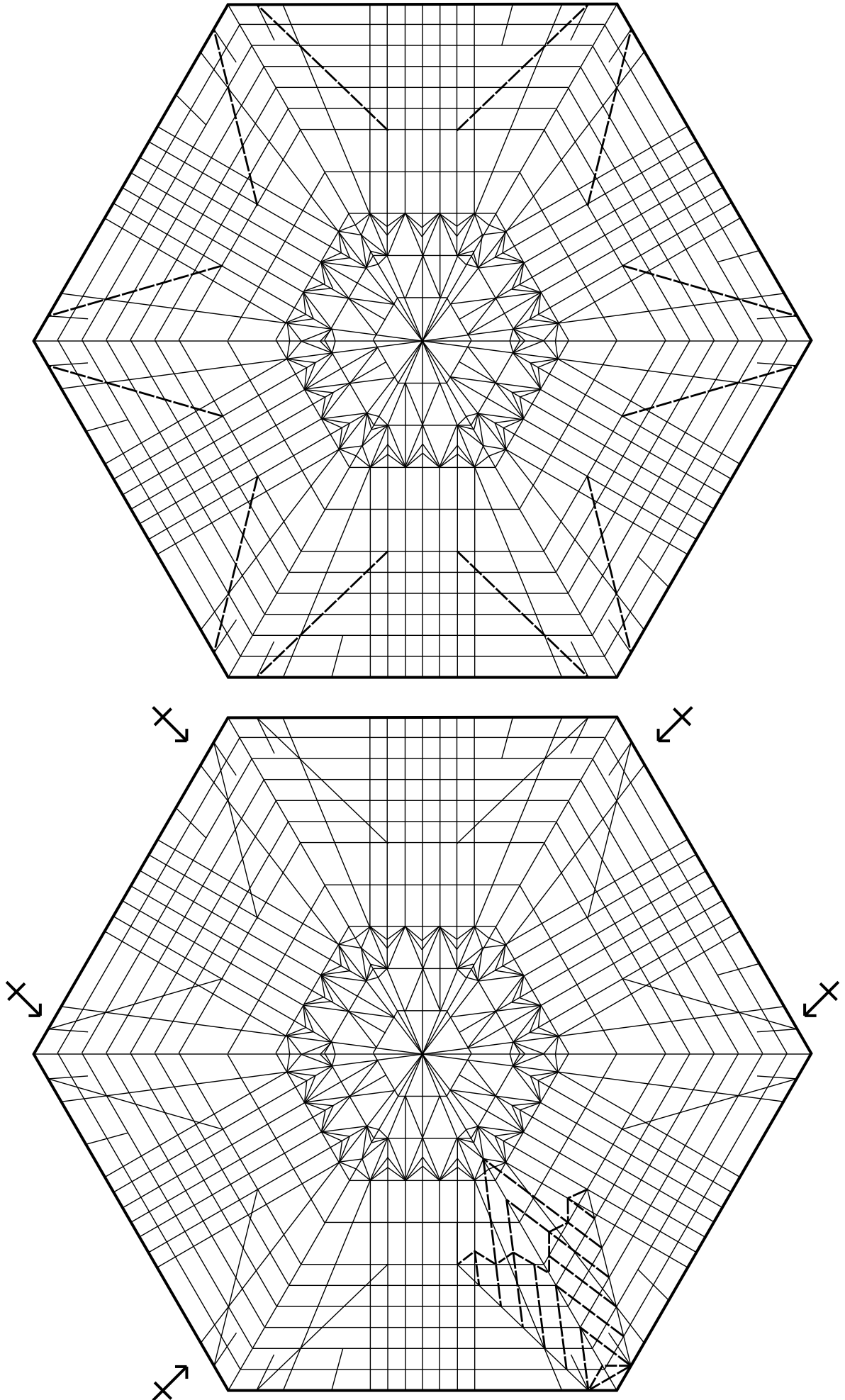

# The Bases of Folding

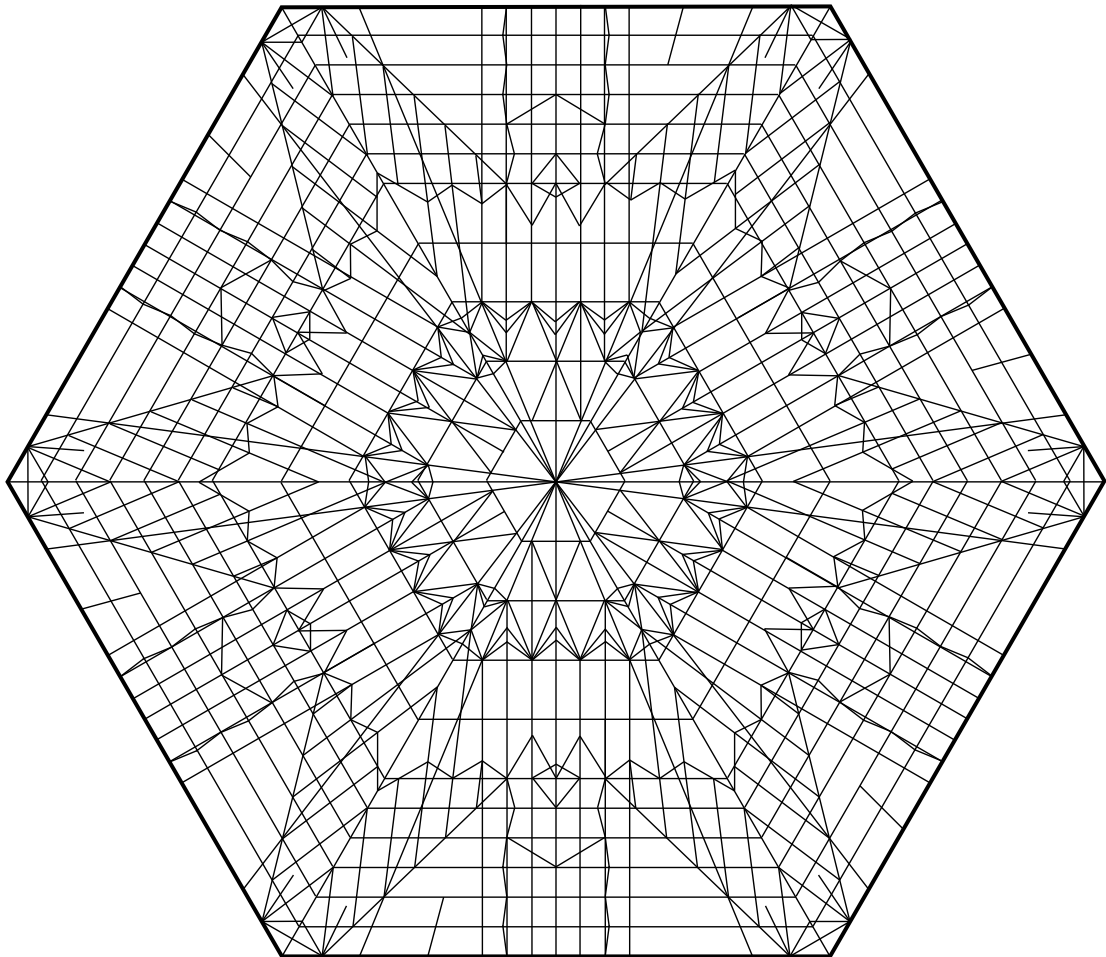
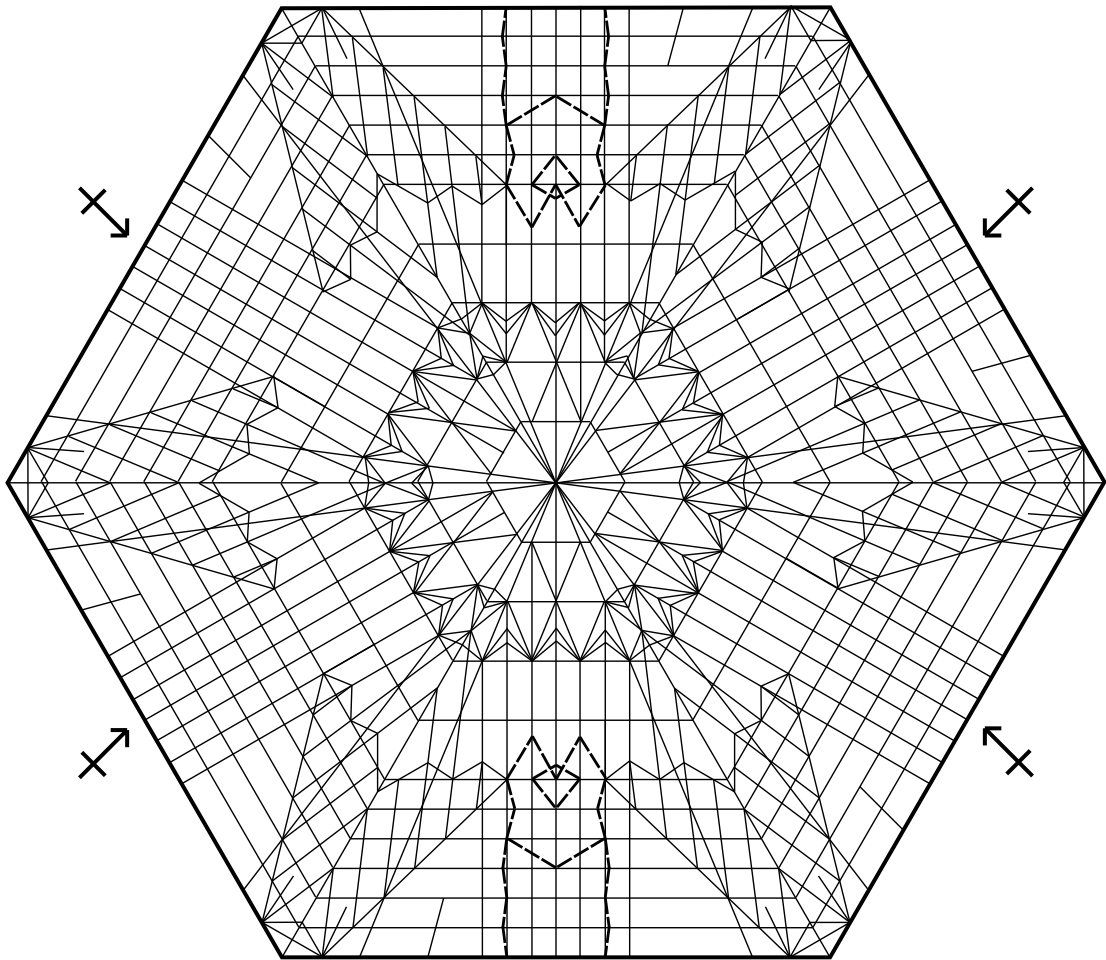

# Minimal Fox

Which is more beautiful, a passionflower or a calla lily? The answer is neither. There are equal parts complexity and simplicity in life, and both are equally appreciated for their aesthetics.

This model may not be as complex as all the other models in this book, but it somewhat looks like a fox, and that's enough for me.

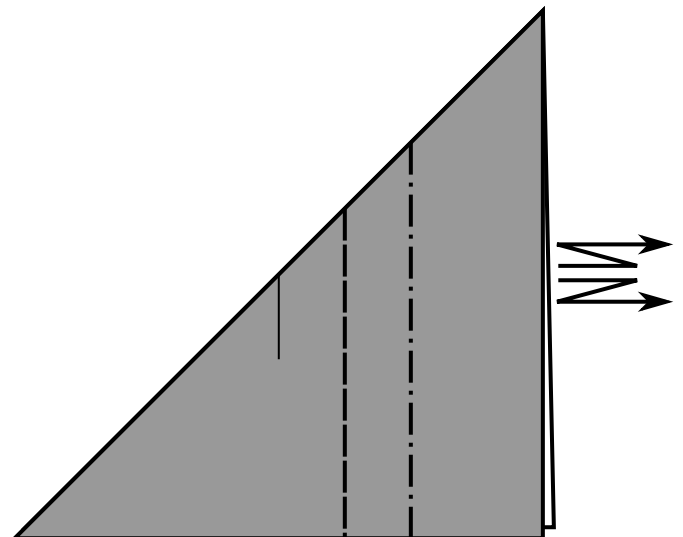
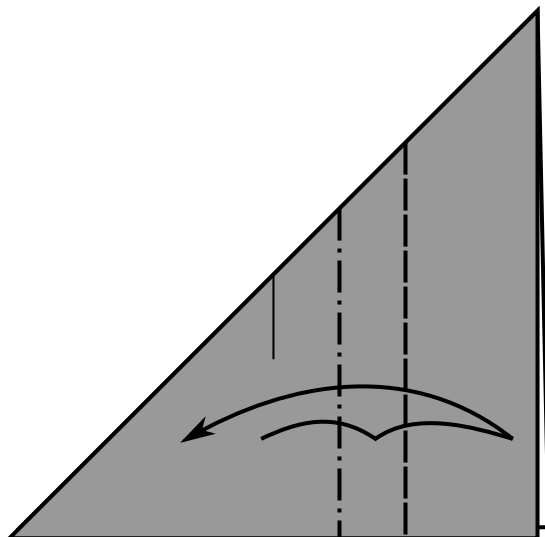
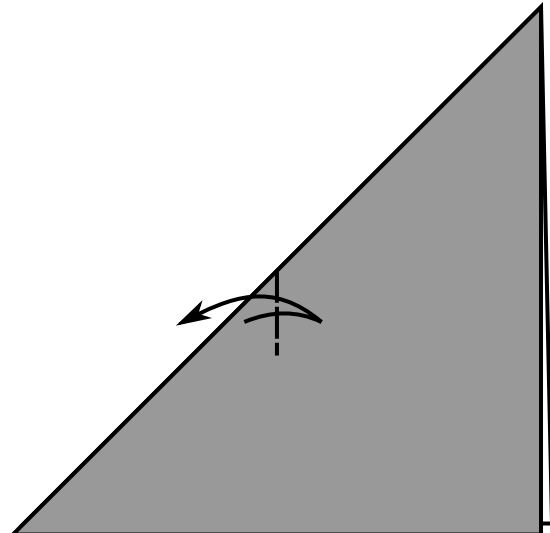
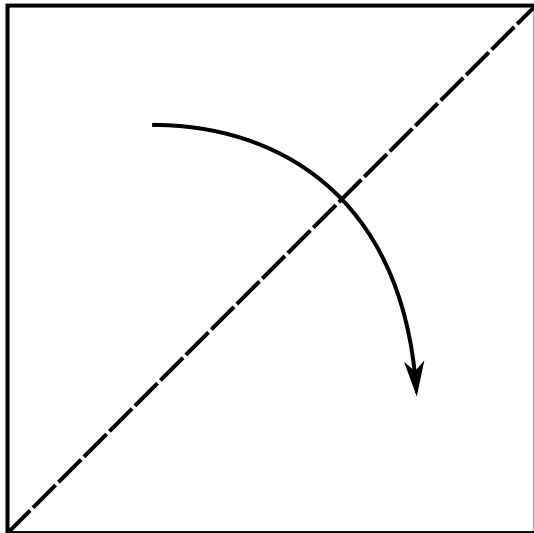
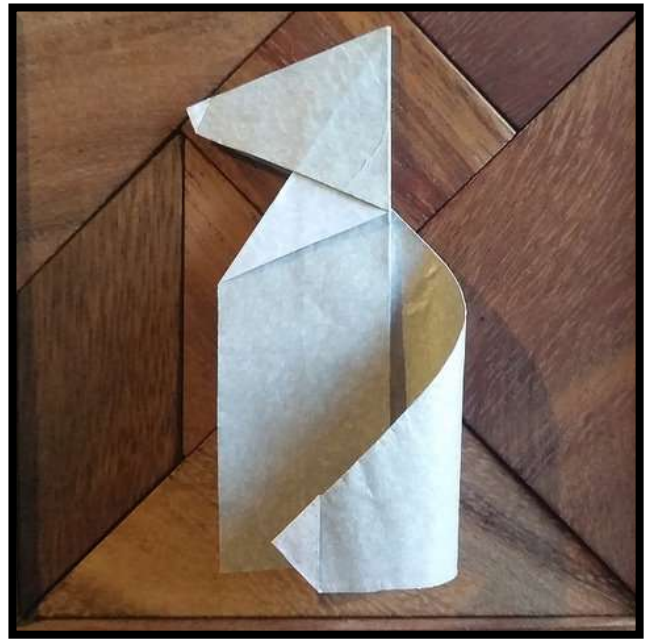

# The Bases of Folding

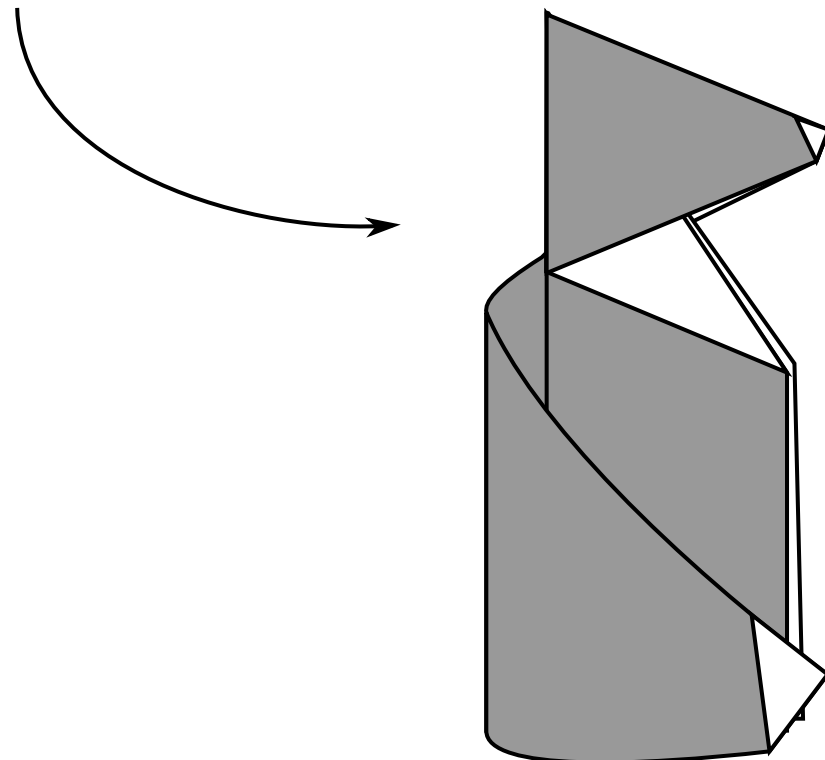
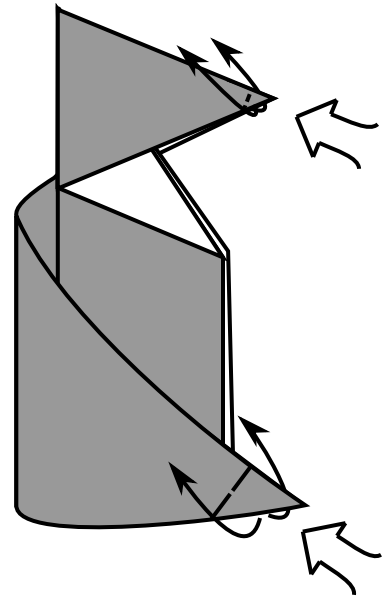
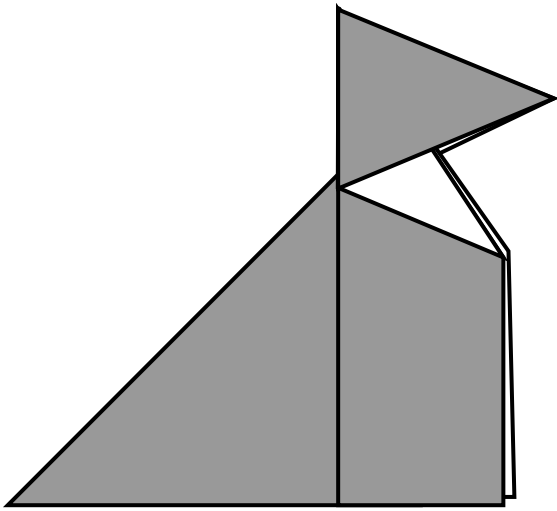
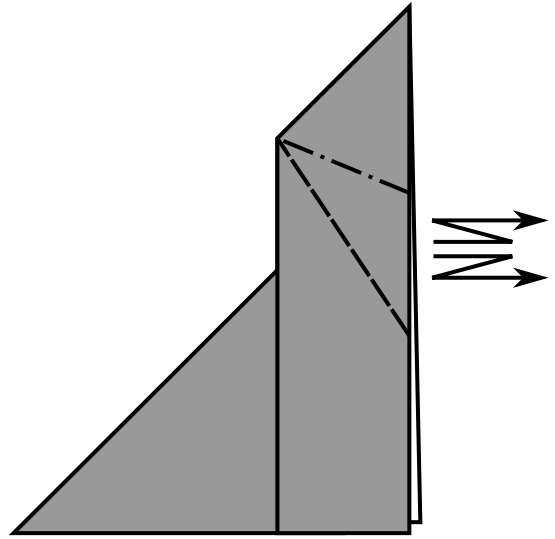
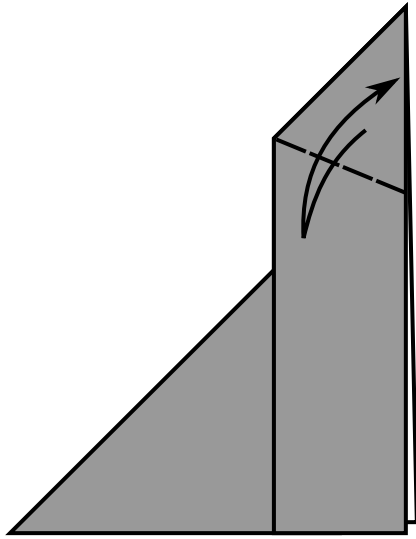

# **Afterword**

**Thank you for downloading this book, and I hope you enjoyed folding these models as much as I enjoyed creating them.**

**This is not a professionally made product, so I apologize if there is anything unclear.**

**If you're having any trouble with a model, you can email me your questions at [josephflemingorigami@gmail.com](mailto:josephflemingorigami@gmail.com)**